

» SR-MDS

Ceiling multi sensor 360°

thermokon[®]
HOME OF SENSOR TECHNOLOGY

Datasheet

Subject to technical alteration
Issue date: 11/16/2020 • A113



» APPLICATION

The wireless ceiling multi sensor is designed for movement detection in room or office spaces. In addition, the sensor detects the ambient brightness in rooms.

The device has the following functions:

- Occupancy detection 360°
- Integrated light sensor 0..47,4 fc (0..510 Lux)
- Optional: Integrated temperature sensor +32..+123,8 °F (0..+51 °C)

» TYPES AVAILABLE

Radio ceiling sensor light + motion

SR-MDS (Power supply 15..240 V =/~)

SR-MDS BAT (Power supply 3x battery 1/2 AA, 3,6 V (LS14250))

Radio ceiling sensor light + motion + temperature

SR-MDS Temp (Power supply 15..240 V =/~)

SR-MDS Temp BAT (Power supply 3x battery 1/2 AA, 3,6 V (LS14250))

» SECURITY ADVICE – CAUTION



The installation and assembly of the device should only be performed by authorized personnel.

The product should only be used for the intended application. Unauthorized modifications are prohibited! The product must not be used in relation with any equipment that in case of a failure may threaten, directly or indirectly, human health or life or result in danger to human beings, animals or assets. Ensure all power is disconnected before installing. Do not connect to live/operating equipment.

Please comply with

- Local laws, health & safety regulations, technical standards and regulations
- Condition of the device at the time of installation, to ensure safe installation
- This data sheet and installation manual

» NOTES ON DISPOSAL



As a component of a large-scale fixed installation, Thermokon products are intended to be used permanently as part of a building or a structure at a pre-defined and dedicated location, hence the Waste Electrical and Electronic Act (WEEE) is not applicable. However, most of the products may contain valuable materials that should be recycled and not disposed of as domestic waste. Please note the relevant regulations for local disposal.

» BUILD-UP OF SELF-HEATING BY ELECTRICAL DISSIPATIVE POWER

Temperature sensors with electronic components always have a dissipative power, which affects the temperature measurement of the ambient air. The dissipation in active temperature sensors shows a linear increase with rising operating voltage. This dissipative power has to be considered when measuring temperature. In case of a fixed operating voltage ($\pm 0,2$ V) this is normally done by adding or reducing a constant offset value. As Thermokon transducers work with a variable operating voltage, only one operating voltage can be taken into consideration, for reasons of production engineering. Transducers 0..10 V / 4..20 mA have a standard setting at an operating voltage of 24 V =. That means, that at this voltage, the expected measuring error of the output signal will be the least. For other operating voltages, the offset error will be increased by a changing power loss of the sensor electronics.

» GUIDELINES FOR DEVICES WITH SOLAR ENERGY STORAGE

Due to the energy-optimized EnOcean radio technology used in "EasySens[®]" wireless sensors, the devices can work without batteries and self-charge themselves using electric energy generated by integrated solar cells. This makes the devices almost maintenance free and environmentally sound due to not having to replace batteries.

For optimum use, the device should be mounted in a location with sufficient ambient brightness. Minimum illumination of 200 lx (artificial light or ambient) is required for at least 3 to 4 hours each day. (The health and safety regulations at work require a minimum illumination of 500 lx for office workplaces).

The solar cell should be mounted facing towards the window direction if possible. If the device has a temperature sensor, then even periodic direct sun radiation should be avoided due to incorrect false temperature readings.

The mounting position should be selected so that the device will not be obstructed in the future: for example by placement areas, additional furniture or roll-fronted cupboards.

The sensor is supplied in an operational state. If the sensor has been stored in darkness for longer periods, the internal solar energy storage will most likely need to be recharged. This would normally happen automatically during commissioning or during initial start up in ambient light. If the initial charge is not sufficient, the sensor will reach its full operating state up to 3 to 4 days, if the requirements for minimum illumination per day are met. The sensor will then transmit continuously in darkness as specified f (2/3 days on factory default telegram timing). Depending on the application it is also possible for the devices to operate in darker rooms (with brightness <100 lx) by using the battery back-up option. Batteries to be used are listed in accessories.

The operating time when using batteries will depend on the transmission frequency as well as the component aging and the self-discharge of the battery. Standard operating time will be 5-10 years on factory default telegram timing. Changing of the device from solar to battery operation is done automatically by simply adding a battery to the device.

» PRODUCT TESTING AND CERTIFICATION



Declaration of conformity

The declaration of conformity of the products can be found on our website <https://www.thermokon.de/>.

» INFORMATION ABOUT EASYSSENS[®] (RADIO) / AIRCONFIG GENERAL USAGE



EasySens[®] - airConfig

Basic information about EasySens[®] radio and about general usage of our airConfig software, please download from our website.

» OVERVIEW OF THE RADIO TELEGRAMS



EEP

The structure of the data contained in the telegram can be found in the EEP (EnOcean equipment profile) list provided by the EnOcean Alliance.

» **TECHNICAL DATA**

Measuring values <i>(type-dependent)</i>	Brightness, motion, optional temperature	
Radio technology	EnOcean (IEC 14543-3-10), transmission power <10 mW EEP A5-08-01	
Power supply	SR-MDS (Temp) flex. 15..240 V =/~,	SR-MDS (Temp) BAT 3x battery LS14250, 3,6 V
Power consumption	typ. 0,8 W (24 V =) 1,2 VA (24 V ~)	
Measuring range temperature <i>(type-dependent)</i>	+32..+123,8 °F (0..+51 °C)	
Measuring range light	0..47,4 fc (0..510 Lux)	
Accuracy temperature <i>(type-dependent)</i>	±0,5 K (typ. at 70 °F)	
Accuracy light	±3 fc	
Transmission interval	WakeUp time = 100 sec. (default) every 100 sec. at change of brightness >1 fc in case of detected motion, every 1000 sec. at change of brightness <1 fc in case of no motion detected, every 100 sec. at change of brightness <1 fc in case of detected motion, every 10 sec. at change of brightness >1 fc in case of detected motion, immediately at status change from no motion to motion, status change from motion to no motion after ≈ <200 sec.	
Detection range	Ø=16 ft. (5 m) at a sensor height of approx. 8 ft. (2,5 m)	
Sensor	PIR (passive infrared)	
Enclosure	ABS, pure white	
Protection	IP20 according to EN 60529	
Connection electrical	terminal, max. 1,5 mm², plugable	
Ambient condition	-10..+50 °C, max. 85% rH non-condensing	
Notes	appropriate for constant light control	

» **COMMISSIONING AND TRANSMISSION TIME INTERVAL SETTING**

To ensure that the measured values of the sensors are correctly evaluated at the receiver, it is necessary to teach the devices into the receiver. This is done automatically using the "Learn" button on the sensor or manually by entering the 32bit sensor ID and a special "teach-in procedure" between transmitter and receiver. Details are described in the respective software documentation of the receiver.

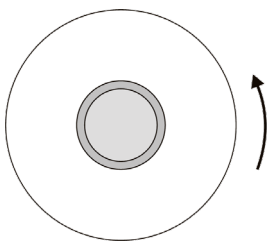

To access the Learn button, turn the sensor cover counterclockwise and remove the cover.

The learn button is located on the bottom of the motion sensor. The exact positioning is shown in the figure on the right.

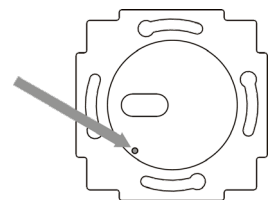

Setting of transmission time

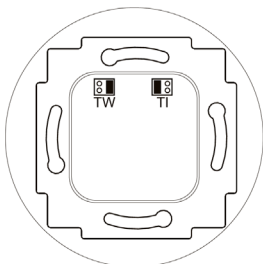

TW (Wake Up) TI (Intervall)

Before opening the device, disconnect it from the power supply!

Factory default: T_wake up: 100, T_intervall: 10
 Transmission time = 100 seconds (T_wake up) x 10 (T_intervall)
 = 1000 seconds = approx. 16 minutes

Note for the battery operated device: The transmission frequency also has a direct influence on the operating energy available in the energy storage device and thus on the discharge time of the energy storage device during operation.

» CONNECTION PLAN

SR-MDS (Temp)

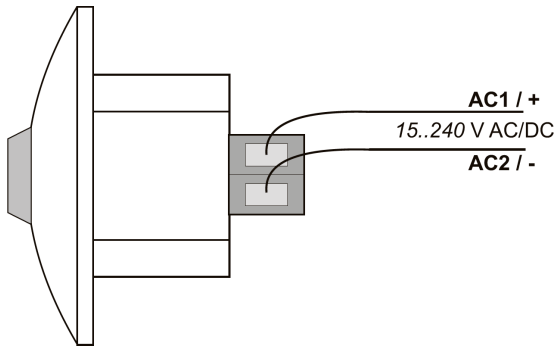

SR-MDS (Temp) BAT

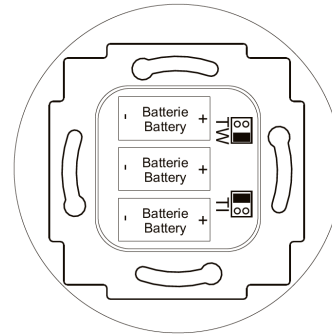

The SR-MDS BAT is battery powered, a wired connection is not necessary. Remove the cover from the backside of the device to insert/exchange the batteries.

» MOUNTING ADVICES

Mounting height

The mounting height has a direct influence on the range of the motion detector. The optimum mounting height is 8.9 ft. (2,7 m). All other dimensions will change the range.

Fixed mounting

The motion detector must be mounted on a solid surface, as any movement of the detector will result in false alarms.

Distance to switched luminaires

In order to avoid unintentional switching on of the luminaire by the motion detector, the luminaire should not be mounted in the detection area of the motion detector. Also avoid mounting the motion detector above a luminaire. The heat radiation of the luminaire can influence the function of the motion detector and possibly lead to a false triggering of the detector.

Mounting sideways to the walking direction

For optimum motion detection, the detector must be mounted to the side of the detection area so that the zones are cut as vertically as possible. Mounting locations where the objects to be detected move directly onto the motion detector result in a significant reduction of the range.

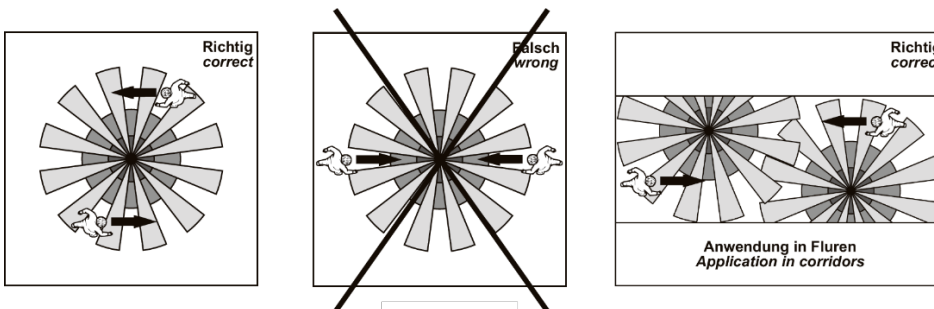

Distance to interference sources

To avoid false alarms, sources of interference such as radiators, lamps, air outlets from air conditioning systems, etc. should be outside the detection range. Direct sunlight should also be avoided.

Feedback on detected movement

Motion detection by the sensor is signalled by the integrated signal LED (flashing for approx. 2 seconds). Note: The signalling LED is independent of the set follow-up time of the relay output. During initialisation of the device (voltage reset), the signalling LED and the relay output are switched on for approx. 45 seconds.

» DETECTION RANGE

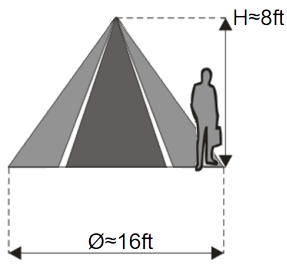

This sensor detects changes in infrared radiation that occur when a person (or object) moves whose temperature is different from the environment.

The specified ranges refer to average conditions at a certain installation height and are therefore to be regarded as guide values. The range can vary greatly with changing temperature conditions. The necessary temperature difference between the detectable object and the environment should be at least 4 K. The speed of the object should be at least 1 to 3.0 ft/s.

» DIMENSIONS (IN.)

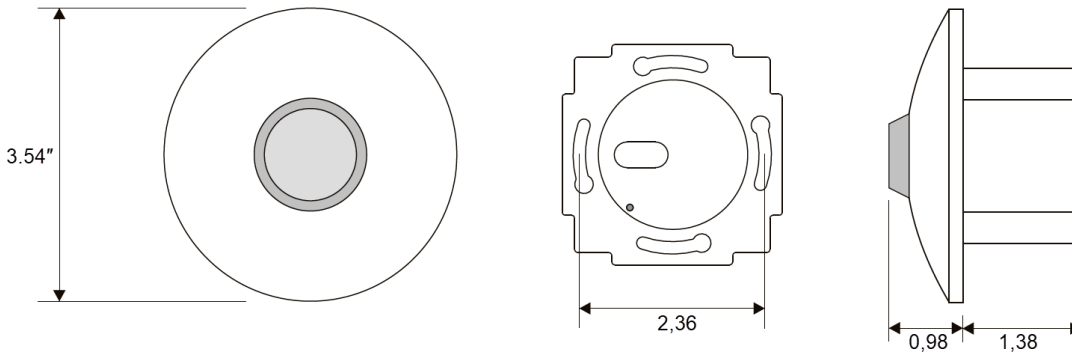

» ACCESSORIES (OPTIONAL)

Enclosure for surface mounting SR-MDS pure white

Item No. 514439