

MOTORIZED VALVES TECHNICAL CHARACTERISTICS AND PERFORMANCES

TECHNICAL DATA	3FGB DN 25÷150	2FSA DN 25÷80	3FSAS DN 25÷80	3FAA DN 25÷125	3FAAP DN 25÷125
Construction	PN16	PN25	PN25 ⁽³⁾	PN40 ⁽⁷⁾	PN40 ⁽⁷⁾
Body	cast iron	spheroidal cast iron	spheroidal cast iron	acciaio	acciaio
Seat	cast iron	stainless steel	stainless steel	stainless steel	stainless steel
Plug	forged brass	stainless steel	stainless steel	stainless steel	stainless steel
Stem (D 9mm)	stainless steel	stainless steel	stainless steel	stainless steel	stainless steel
Control characteristic	direct way = equal perc. Angle way = linear	direct way = equal perc. (DN25÷65) linear (DN80) angle way = linear	direct way = equal perc. (DN25÷65) linear (DN80) angle way = linear	linear	linear
Stem packing	EPDM O-Ring ⁽⁵⁾	Teflon V-ring	stainless steel bellows	Teflon V-ring	(2)
Max. fluid temp. °C	150	230	300	230	350
Min. fluid temp. °C	-10 ⁽¹⁾	-10 ⁽¹⁾	-10 ⁽¹⁾	-10 ⁽¹⁾	-20 ⁽¹⁾ (4)
Fluid ⁽⁶⁾	Group 2	Group 2	Group 1	Group 2 and 1	Group 1
Connections	Flanged PN16	Flanged PN25	Flanged PN25	Flanged PN40	Flanged PN40
max Kvs leakage % ⁽⁸⁾	direct way 0,03 angle way 2	0,02	0,02	0,02	0,02

- (1) For applications with possible ice formation on stem and gasket, see 248 accessory.
 (2) Graphite packing for high temperatures; forced lubrication on extended neck. Teflon packing for low temperatures, see (4).
 (3) Due to the bellows presence, the max applicable pressure must not be higher than 5bar.
 (4) For applications on fluids from -10 to -20°C replace letter P with the T, e.g. 3FAA50T. In such case the max temperature is 230°C

- (5) Double O-ring and graphite teflon scraper ring.
 (6) Group 1: water, overheated water, steam, diathermic oil.
 For different fluids belonging to group 1, please contact our Sales Support.
 Group 2: water, overheated water, glycole added water (50% max.) steam.
 For different fluids belonging to group 2, please contact our Sales Support.
 (7) PN25 only for 3FAA125 and 3FAA125P.
 (8) Leakage is measured according to the EN1349 standard.

USE

3F.. series valves are used to control fluids belonging to the group showed in the table in accordance to article 9 of 97/23/CE (PED) directive, in air-conditioning, thermoventilation and heating plants and in industrial processes; therefore, they cannot be used as safety valves.

MANUFACTURING CHARACTERISTICS

They consist in a 3-way valve body to be assembled on electrical bidirectional actuator.

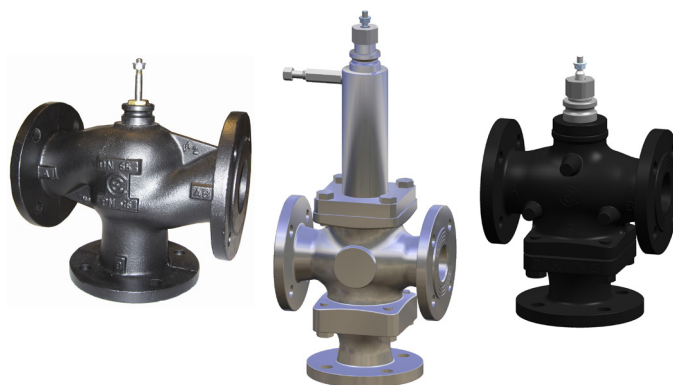

Controlli S.p.A.
 16010 Sant'Olcese (GE)
 Tel. 010 73 06 1
 Fax. 010 73 06 870/871
www.controlli.eu

INSTALLATION

HYDRAULIC CONNECTIONS

Respect the fluid direction as indicated in Fig. 1 and 2. In particular, we specify that the valves must be mounted as mixing valves with inlet in A and in B and outlet AB.

VALVE MOUNTING

Before mounting the valve, make sure pipes are clean, free from welding slags. The pipes must be perfectly aligned with the valve body and not subjected to vibrations. For installations on plants with high temperature fluids (steam, overheated water, diathermic oil) use expansion joints to avoid the dilatation of pipes to stress the valve body.

Install the valves with the actuator in vertical position for fluid temperature up to 120°C, with higher temperatures they must be mounted horizontally.

NOTE: Following the hydraulic installation it is necessary to check the tight of the stem packing placed on the bonnet, both in cases of low and high temperatures. The valves require periodic maintenance.

Avoid the valve installation in plants, which are considered aggressive and/or corrosive for valve materials.

Please contact our Sales Support in order to determine which potentially aggressive or polluting substances can be used.

We disclaim all responsibility in case of valve failure due to external fortuitous events (fire, earthquakes etc.).

Note: The actuator can be rotated with respect to the valve body by blocking the ring nut; after such operation re-tighten the ring nut.

Attention: The stem of 3FSA.S bellows seal valves must never rotate with respect to the valve body if it is connected to through the bellows.

ACTUATORS TECHNICAL CHARACTERISTICS, WIRING DIAGRAMS AND INSTALLATION

See actuators data sheets and mounting instructions.

MOTORIZED VALVES OPTIONS

MODEL	DESCRIPTION
A125-3	flanges with ANSI125 bolt holes (for 3FSA/3FSAS DN50÷65 and 3FGB DN25÷150)
A150-3	flanges with ANSI 150 bolt holes (for 3FSA/3FSAS DN50÷65 and 3FAA/3FAAP DN50÷125 valves)
A300-3	flanges with ANSI 300 bolt holes (for 3FSA/3FSAS DN25÷65, 3FAA/3FAAP DN32÷65 and DN100÷125 valves)

ACCESSORIES

MODEL	DESCRIPTION
248	stem heater for applications on -10°C low temperature fluid with MVH, MVF and MVE actuators

SCHEMI APPLICATIVI

Constant flow mixing to the user

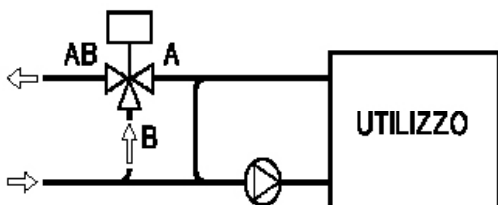

Variable flow mixing to the user

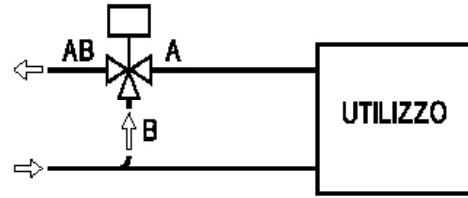

OVERALL DIMENSIONS (mm)

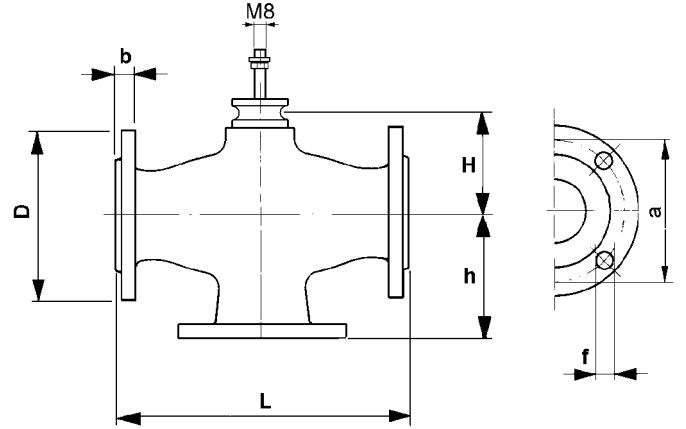

3FGB

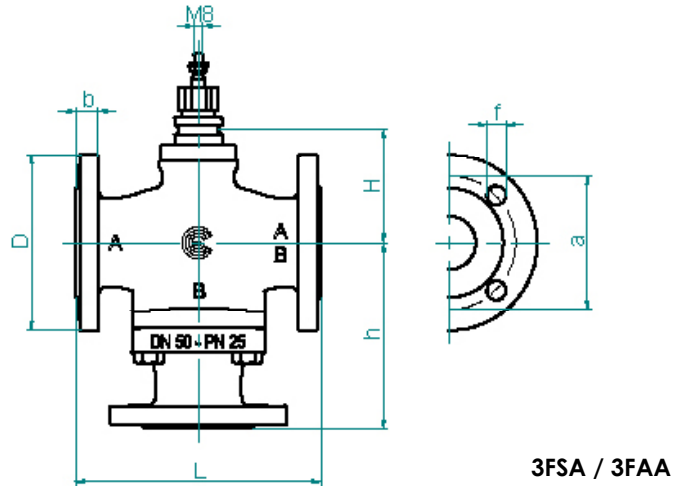

3FSA / 3FAA

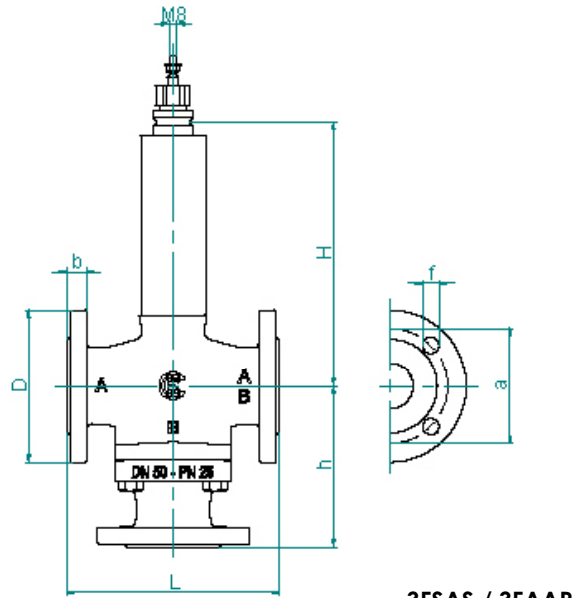

3FSAS / 3FAAP

MAX DIFFERENTIAL AND CLOSE-OFF PRESSURE (kPa)

U-Bolt Connection	DN	Kvs	MVH		MVHA/C*		MVH3K		MVF59A/C		MVEX06		MVEX10		MVEX15	
			A-AB	B-AB	A-AB	B-AB	A-AB	B-AB	A-AB	B-AB	A-AB	B-AB	A-AB	B-AB	A-AB	B-AB
3FGB	25R4	4	1600	1600	1100	840	1600	1600	1400	1100	940	700	1590	1270	1600	1600
	25R7	6,3	1600	1600	1100	840	1600	1600	1400	1100	940	700	1590	1270	1600	1600
	25	10	1600	1600	1100	840	1600	1600	1400	1100	940	700	1590	1270	1600	1600
	40R	19	1170	990	590	470	1600	1600	750	620	500	390	860	710	1300	1110
	40	25	1170	990	590	470	1600	1600	750	620	500	390	860	710	1300	1110
	50	40	730	630	360	300	1600	1440	470	390	310	250	530	450	810	710
	65	63	430	370	210	170	960	850	270	230	180	150	310	270	480	420
	80	100	280	240	130	110	620	560	-		110	90	200	170	310	270
	100	130	170	150	80	70	390	360			70	60	120	110	190	175
	125	200	100	100	50	40	240	230			40	40	70	70	120	110
150	300	70	70	30	30	160	160	30			20	50	50	80	75	
3FAA 3FAA...P	25R4	4	2150	1920	1080	770	3000	3000	1390	1090	930	600	1580	1300	2390	2170
	25R7	6,3	0	0	0	0	0	0	0	0	0	0	0	0		
	25	10	0	0	0	0	0	0	0	0	0	0	0			
	32	16	1450	1210	730	480	3000	2960	930	690	620	380	1060	820	1610	1370
	40	22	940	790	470	310	2090	1940	600	450	400	240	690	530	1050	900
	50	32	660	560	330	220	1470	1370	420	320	280	170	480	370	740	630
	65	70	390	330	190	130	860	810	240	180	160	100	280	220	430	370
	80	110	250	210	120	80	570	530	-		100	60	180	140	280	240
	100	140	160	140	70	50	360	340			60	40	110	90	170	150
	125	250	100	80	40	30	230	210			30	20	70	60	110	100
3FSA	25R4	4	2500	2500	2150	1250	2500	2500	2500	1850	1850	950	2500	2220	2500	2500
	25R7	6,3	2150	1690	1080	630	2500	2500	1390	930	930	470	1580	1120	2390	1930
	25	10	2150	1690	1080	630	2500	2500	1390	930	930	470	1580	1120	2390	1930
	32	19	1450	1140	730	420	2500	2500	930	620	620	310	1060	750	1610	1300
	40	25	1040	820	520	300	2310	2080	670	440	440	220	760	540	1160	940
	50	40	660	520	330	180	1470	1330	420	280	280	130	480	340	740	590
	65	63	390	300	190	100	860	780	240	160	160	70	280	190	430	340
	80	100	250	230	120	105	500	500	-		100	85	180	160	280	220
3FSA...S	25R4	4	500	500	500	500	500	500	500	500	500	500	500	500	500	500
	25R7	6,3	500	500	500	500	500	500	500	500	500	500	500	500	500	500
	25	10	500	500	500	500	500	500	500	500	500	500	500	500	500	500
	32	19	500	500	500	500	500	500	500	500	500	470	500	500	500	500
	40	25	500	500	500	420	500	500	500	500	440	340	500	500	500	500
	50	40	500	500	330	270	500	500	420	360	280	220	480	420	500	500
	65	63	390	350	190	160	500	500	240	210	160	130	280	250	430	400
	80	110	250	230	120	100	500	500	-		100	80	180	160	288	260

* MVHA in emergency closes direct way; MVHC in emergency opens direct way.

NOTE In order to avoid wear between plug and seat, we recommend not to overcome the differential pressure as follows:
 3FGB = 2bar
 3FSA = 8bar
 3FAA/3FAAP = 12bar

Kvs is the flow rate expressed in m³/h of water at a temperature between 5°C and 40°C passing through a valve open at the nominal stroke with 100kPa (1bar) differential pressure.

Note The max operating pressures at different temperatures for PN various classes must correspond to the following standards: UNI 1092-2 and UNI 12516-1.

MODEL	DN	L	H	h	D	B	A	F	HOLES NR.	WEIGHT (Kg)	STROKE (mm)
3FGB (PN 16)	25	160	50	80	115	16	85	14	4	5,2	16,5
	40	200	64	100	150	18	110	18	4	9,4	25
	50	230	66	115	165	20	125	18	4	14	25
	65	290	84	145	185	20	145	18	4	19,1	25
	80	310	94	155	200	22	160	18	8	23,5	45
	100	350	105	175	220	22	180	18	8	32	45
	125	400	128	200	250	24	210	18	8	45,6	45
	150	480	146	240	285	24	240	22	8	61,2	45
3FSA (PN 25)	25	160	92	137	115	18	85	14	4	8	16,5
	32	180	97	159	1240	20	100	18	4	12	25
	40	200	98	162	150	20	110	18	4	14	25
	50	230	107	171	165	22	125	18	4	18	25
	65	270	117	190	185	24	145	18	8	25	25
	80	310	181	207	200	26	160	18	8	42,8	45
3FAA (PN 40)	25	160	124	140	115	17	85	14	4	12,4	16,5
	32	180	139	157	140	17	100	18	4	182,2	25
	40	200	165	160	150	17	110	18	4	21,6	25
	50	230	168	172	165	19	125	18	4	26	25
	65	270	183	190	185	21	145	18	8	36	25
	80	310	199	207	200	23	160	18	8	47,8	45
	100	350	178	247	235	24	190	22	8	55	45
	125	400	203	282	270	26	220	25	8	78	45
3FSAS (PN 25)	25	160	274	137	115	18	85	14	4	10	16,5
	32	180	279	159	140	20	100	18	4	15	25
	40	200	280	162	150	20	110	18	4	17	25
	50	230	289	171	165	22	125	18	4	21	25
	65	270	299	191	185	24	145	18	8	29	25
	80	310	413	207	200	26	160	18	8	45,6	45
3FAAP (PN 40)	25	160	195	140	115	18	85	14	4	15,7	16,5
	32	180	269	157	140	18	100	18	4	22,3	25
	40	200	277	160	150	18	110	18	4	25	25
	50	230	293	172	165	20	125	18	4	29,7	25
	65	270	308	190	185	22	145	18	8	39,3	25
	80	310	324	207	200	24	160	18	8	50,8	45
	100	350	303	247	235	24	190	22	8	67	45
	125	400	328	282	270	26	220	25	8	98,6	45

The performances stated in this sheet can be modified without any prior notice due to design improvements

Globe Valves Actuators

MODEL	FORCE [N]	POWER SUPPLY	DESCRIPTION
MVE204-2-RS	400	230 V AC	Long yoke, modulating
MVE206-2-RS	600		
MVE210-2-RS	1000		
MVE215-2-RS	1500		
MVE222-2-RS	2200		
MVE204S-2-RS	400	230 V AC	Short yoke, modulating
MVE206S-2-RS	600		
MVE210S-2-RS	1000		
MVE215S-2-RS	1500		
MVE222S-2-RS	2200		



APPLICATION AND USE

MVE2xxx-2-RS is an intelligent device equipped with 2 temperature inputs and with RS-485 (Modbus-RTU) network connectivity for Supply&Return and DeltaT control and limitation as well as for integration with the Building Management System (BMS).

MVE2xxx-2-RS can be connected to 2 temperature sensors for the supply and return temperature monitoring and control. The actuator is able to implement a temperature control loop without the need of a BMS controller with significant savings in terms of hardware (eg. controllers with less I/Os, more compact electrical panels) and field wiring.

MVE5xxx-2-RS is designed for the control of two and three way globe valves usable in:

- heating and air conditioning systems;
- air handling units;
- district heating plants;
- industrial control systems.

The actuator can be controlled by a Modbus RTU (master) device via an RS-485 network bus as well as by a proportional (modulating) control signal.

The installation and commissioning of MVE2xxx-2-RS is quick and easy thanks to the U-Bolt type valve connection and self-diagnostic functions able to guarantee correct and error-free installation. It can be mounted on all types of iSMA CONTROLLI flanged valves, while connection kits are available for iSMA CONTROLLI threaded valves and valves from other manufacturers (table on page 3).

The actuator has a very high resolution (500 steps over the entire stroke range) for precise control of the fluid temperature and is able to self-calibrate on different strokes without requiring user action. The compact models MVE2xxxS-2-RS are equipped with a short yoke for applications with limited space.

MVE2xxx-2-RS is also equipped with a USB port for local configuration and diagnostics. When USB cable is connected, the motor can't move.

TECHNICAL CHARACTERISTICS

DESCRIPTION	MVE204-2-RS MVE204S-2-RS	MVE206-2-RS MVE206S-2-RS	MVE210-2-RS MVE210S-2-RS	MVE215-2-RS MVE215S-2-RS	MVE222-2-RS MVE222S-2-RS
Supply voltage L1 Ln	AC: 230 V AC \pm 10% 50-60 Hz				
Power consumption (running)	10 VA/4,5 W	13 VA/6 W	18 VA/8 W	21 VA/11 W	25 VA/11 W
Power consumption (holding)	8 VA/4 W	11 VA/5 W	11 VA/5 W	13 VA/7 W	13 VA/7 W
Running time	16 s @ 45 mm				
Transformer Size [VA]	20	20	30	50	50

The performances stated in this sheet can be modified without any prior notice.

DESCRIPTION	MVE204-2-RS MVE204S-2-RS	MVE206-2-RS MVE206S-2-RS	MVE210-2-RS MVE210S-2-RS	MVE215-2-RS MVE215S-2-RS	MVE222-2-RS MVE222S-2-RS
Stroke	5-60 mm (limited to 30 mm for MVE.S-2-RS)				
Force	400 N	600 N	1000 N	1500 N	2200 N
Duty cycle	Max 50%/60 minutes				
Analogue input Y M	Voltage 0-10 V DC - impedance > 100 kΩ (range: 0-10 V DC, 2-10 V DC, 0-5/2-6 V DC, 5-10/6-10 V DC) 500 Ω (range 4-20 mA)				
Output V+	Voltage 16 V DC ± 0,5 V DC; max load 25 mA				
Output U	Voltage 2-10 V DC (0-100%); max load 2 mA				
Cycles number of manual action	6.000				
Cycles number of automatic action	100.000				
Type of action	Type 1				
Type of movement	Linear				
Room temperature	Operation -10T55°C; storage -20T55°C				
Room Humidity	Max 90% R.H.				
Protection degree	Nema 2 (*) / IP54 (**)				
Insulation class	III				
Printed Circuit Board	FR4 (material), PLC (Performance Level Categories) = 3, PTI (Proof Tracking Index) = 175 - 249 V CTI (Comparative Tracking Index) = PTI, Pollution Degree = 2				
Standard	Emission/Immunity EMC 2014/30/UE according to EN 61326-1:2013 standard LVD 2014/35/UE according to EN61010-1 standard				
Material	Housing: aluminium - cover: ABS plastic				
Colour	Aluminium / white				
Weight [kg]	1,7 (MVE2xx-2-RS); 1,6 (MVE2xxS-2-RS)				
Date code	yy/ww				

***To guarantee "Nema Type 2" protection:**

- use flexible metal conduit (not supplied);
- Push the listed conduit fitting device (PG13,5 - not supplied) over the actuator's cable to butt against the enclosure. Screw in conduit connector. Jacket the actuators input wiring with listed flexible conduit. Properly terminate the conduit in a suitable junction box.

****To guarantee IP54 protection**

- Insert the actuator cable in the PG13,5 cable gland (not supplied).

OPERATION

MVE2xxx-2-RS is equipped with a modern brushless direct current motor that drives a gear train and converts engine revolutions into accurate and repeatable linear movements on the valve stem.

MVE2xxx-2-RS can be controlled by 2 types of signal:

- Modbus command;
- modulating (or proportional) with selectable type (e.g. voltage or current) and range (e.g. 0-10 V DC, 2-10V DC, 0-5 / 2-6 V DC, 5-10 / 6-10 V DC and 4-20 mA).

The control mode can be set via Modbus, via USB or via the dip-switches (only 0-10 V DC, 2-10 V DC and 4-20 mA are selectable) on the board. All settings and configurations can be done over the RS-485 network or USB connection by the free-of-charge software MVE-2-RS Configurator as well as by the BMS over the RS-485 network.

Modbus Registers description is available in Product Manual DMP283en.

FUNCTIONS AND SETTINGS

Diagnosics

The actuator is equipped with a self-diagnostic algorithm able to detect the following conditions/anomalies:

- actuator status (Normal Operation, Calibration, Initialization, Fault, Manual).
- Calibration attempt on a stroke not in the range 5-60 mm.
- Unexpected stall (e.g. valve blocked or extra stroke due to actuator not correctly coupled); the number of detected events is stored permanently.
- Supply voltage outside the allowed range; the number of detected events is stored permanently.
- Total number of opening and closing cycles.

- Temperature sensors outside the allowed temperature range (if any).

All this diagnostic information is available through dedicated Modbus registers and can be read by the BMS and the MVE-2-RS Configurator. Diagnostic data is also available via the USB connection.

Furthermore, the anomaly conditions are locally shown by means of two green and red LEDs on the board which are suitably flashing (see table on page 9).

Temperature control loop

MVE2xxx-2-RS can be connected to 2 sensors for measuring the supply and return temperature of a hydraulic circuit for monitoring purposes or for control purposes.

The actuator can implement a temperature control loop (PID): the actuator independently controls the supply or the return temperature or the Delta T according to a set-point provided by the BMS; the BMS only sets the temperature\Delta T setpoint and the actuator works independently even in the absence of the Modbus connection.

If only temperatures monitoring is required, the measured values are made available to the BMS through dedicated Modbus registers.

Temperature setpoints, PID control parameters, Heating/Cooling mode can be set via Modbus or via USB by the MVE-2-RS Configurator.

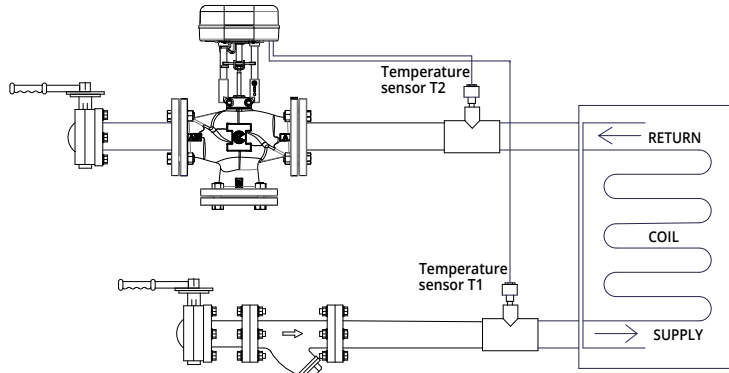

ΔT control loop (water heating example)

T Return control loop (water heating example)

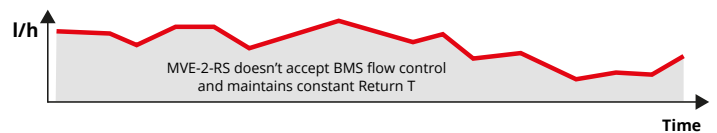
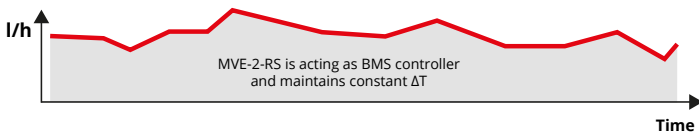
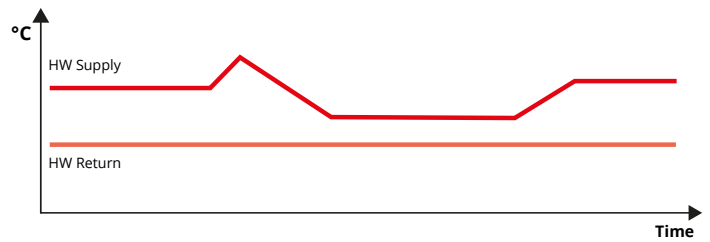
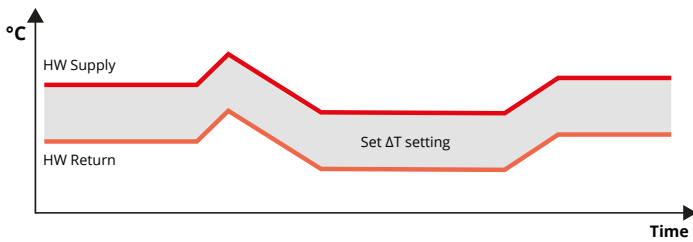

Delta T limit function

If a heating or cooling system works with a differential temperature between the supply and return too low, it means that there is no heat exchange between the fluid and the air flow and therefore it is more efficient to reduce the fluid flow as this does not generate any heating or cooling effect. This means that the pumps circulate too much water with unnecessary increase of energy consumption.

The Delta T limit function automatically limits the flow rate to prevent the Delta T level from falling below the desired differential temperature.

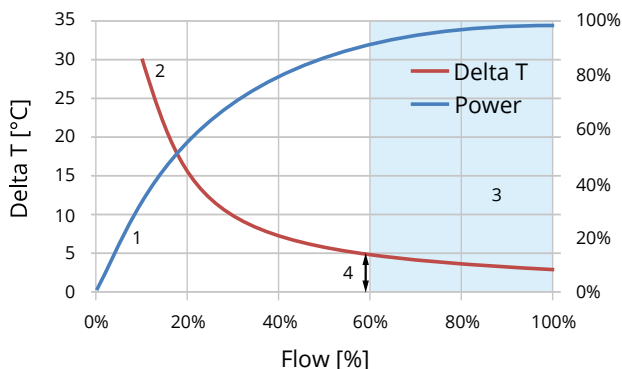

- 1 – Power output of the heating or cooling coil
- 2 – Diff. temperature between supply and return
- 3 – Loss zone (heating or cooling coil saturation)
- 4 – Adjustable minimum differential temperature

This function overrides the control signal from the BMS when the DeltaT is lower than the setpoint; BMS will be again in charge of the valve positioning when the deltaT is higher than the setpoint.

The minimum value of Delta T and the other parameters of the control loop (PID) can be set via Modbus or via USB.

Min ΔT limitation (water cooling example)

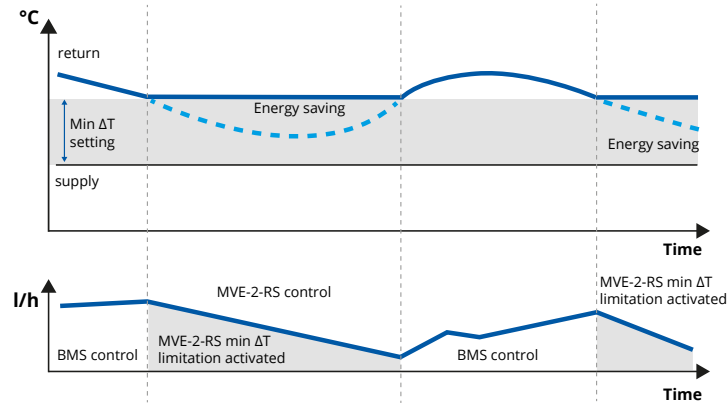

Supply/Return temperature limit function

MVE2xxx-2-RS can implement a limit control loop on the return temperature or on the supply temperature in order to override the BMS control when energy efficiency conditions are not respected (e.g. in cooling mode return temperature higher than a setpoint value). The following limiting functions can be implemented:

- Maximum temperature limit control loop: the actuator will override the BMS control signal when the supply \return temperature is higher than the setpoint; the user can select if the loop has to be implemented on the supply or return temperature sensor. For example in a domestic hot water application the actuator can override the bms control signal if the supply temperature exceeded a setpoint value that could be dangerous for the user.
- Minimum temperature limit control loop: the actuator will override the BMS control signal when the supply \return temperature is lower than the setpoint; the user can select if the loop has to be implemented on the supply or return temperature sensor. For example in a cooling application the actuator can override the BMS control signal if the return temperature is lower than a setpoint value in order not to affect the chiller efficiency.

Max T Supply limitation (water heating example)

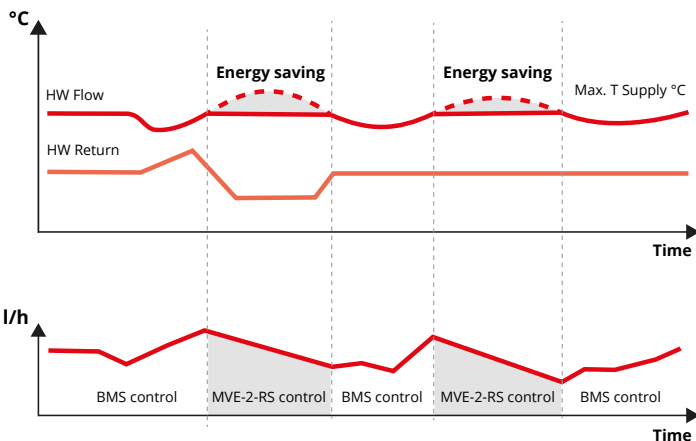

Min T Supply limitation (water cooling example)

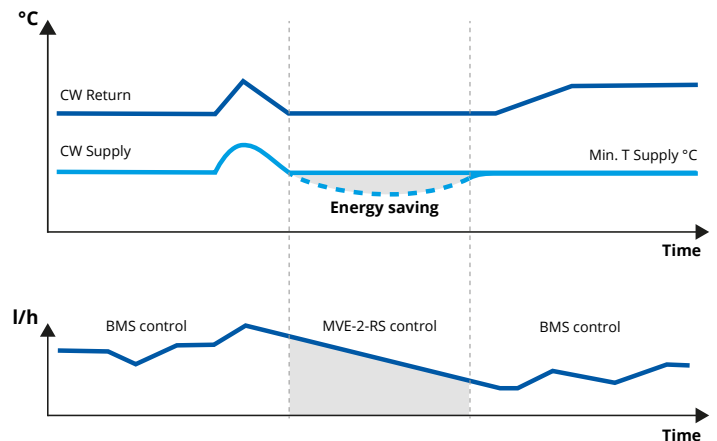

Max T Return limitation (water heating example)

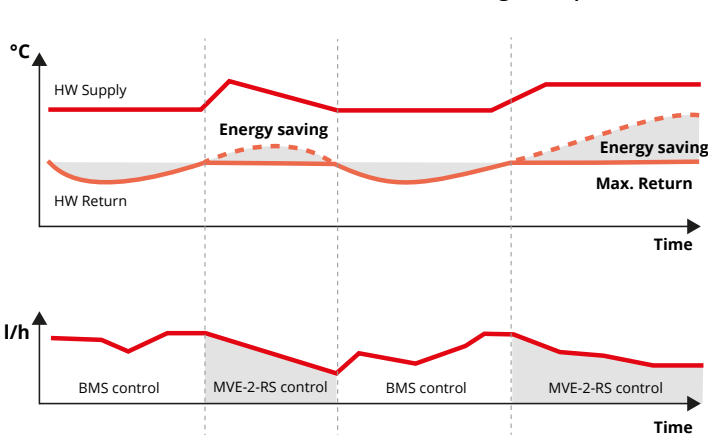

Min T Return limitation (water cooling example)

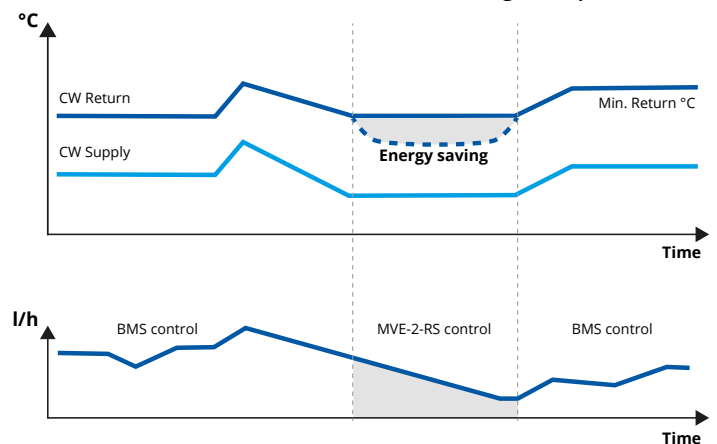

Manual Override

There is a manual operation handle on the actuator. When it is low the manual override is engaged and the valve can be manually positioned. The manual override handle stays in position until it is raised again, then board and motor will be powered again. When the manual override is engaged the GREEN and the RED LED are ON. Manual operation handle can also be used to modify any DIP switch setting or as reset function after any alarm occurrence.

Position Feedback

The current position of the actuator is made available via Modbus (0-100%) as well as via a 2-10 V DC analog signal.

Calibration function

MVE2xxx-2-RS is equipped with an automatic calibration function.

The plug & play function enables the calibration at the first start-up of the actuator and therefore no further calibration operations are required unless maintenance is required on the valve or particular alarm conditions occur. If it is necessary to repeat the calibration, it can be activated by pressing the S2 button on the electronic board or remotely via Modbus.

End points switches (DMVE accessory)

The end points relays switch when the valve is fully open or closed. These are dry contacts (24 V AC/DC, 4A max). Auxiliary switches can be used to indicate the end position of the valve and for relay control of other devices.

When the actuators are controlled individually or in sequence, it is possible to use the limit switches to indicate the total closing or opening of the valve. The table below indicates the position of the switch based on the 0..10 V DC (Y) command signal.

CONTROL SIGNAL (Y)	RELAY KC1	RELAY KC2
0-0,5 V DC	KC1 to K2	KC2 to K3
0,5-9,5 V DC	KC1 to K1	KC2 to K3
9,5-10 V DC	KC1 to K1	KC2 to K4

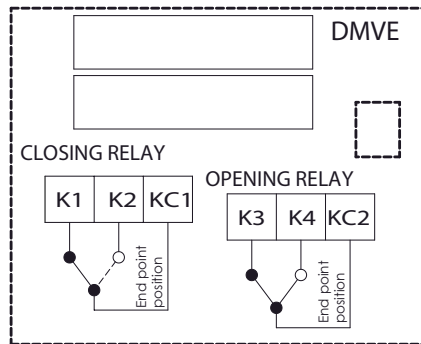

Installation instructions

Position the valve stem at the end of its travel, slide the actuator onto the valve bonnet; adjust the position of the actuator with the manual control so that the square nut on the valve stem fits perfectly with the slot on the connection plate. Slide the U-shaped bolt into the groove of the valve bonnet and secure it with the nuts.

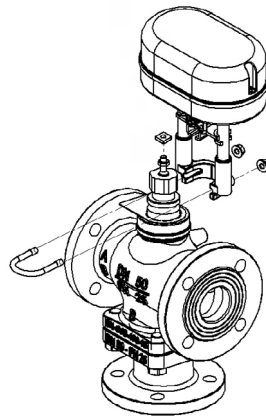

For further details see the Assembly Instructions (MVE2xxx-2-RS_DIM334en).

MAINTENANCE

The actuator is maintenance-free.

ACCESSORIES

- DMVE** End point auxiliary switches (electrical rate 24V AC/DC, 4A max)
- GMVE** Thermal insulation for MVE actuators *
- GMVES** Thermal insulation for MVE.S actuators *

- iSMA-B-CVT-RS485** USB to RS485 Converter, USB 1.0 and 2.0 compatible, built-in: status LEDs, switchable terminating resistor, EEPROM memory. Communication over 3-wire bus. The miniUSB to USB cable is not included.
- PA** 1/2" M Immersion sensor pocket pair, length 45 mm, internal \varnothing 6 mm
- PB** 1/2" M Immersion sensor pocket pair, length 85 mm, internal \varnothing 6 mm
- SNTC-SL-3-EBV** NTC 10K temperature sensor 3 m length (10 m length available on request)
- 248** Stem heater (suggested when the fluid temperature is below 0°C) *
- * It is not possible to install both thermal insulation (Gxxxx) and stem heaters.

COMPATIBLE VALVES AND ACTUATORS

iSMA CONTROLLI VALVES	MVE2.-2-RS	MVE2.S-2-RS
Current iSMA CONTROLLI valves	•	-
VSXT09PBP, VSXT10PBP	-	only with MVE504S-2-RS
2-3TGB.F PN16	-	•
iSMA CONTROLLI valves with threaded M40 connections (except for VSB-VMB, VSB.F-VMB.F PN16)	with AG51	-
VSB-VMB, VSB.F-VMB.F PN16	with AG52	with AG63
OTHER MANUFACTURERS VALVES	MVE2.-2-RS	MVE2.S-2-RS
Belimo H2..X-S e H3..X-S	with AG82	with AG82
Siemens *	with AG70-10 with AG70-14	-
Danfoss (VR/VF (S) models)	with AG60-07	-
TAC DN15-V298	with AG60-08	-
TAC DN15-V2XX/V3XX	with AG60-09	-
Honeywell **	with AG60-10	-
Airtek	with AG60-11 with AG60-12	-
Johnson Controls VB7816-2111	with AG66	-
Johnson Controls BM-3018-3300	with AG67	-
MUT MK DN50-150	with AG69	-
Tac Venta	•	-

* AG70-10 for valves having stem \varnothing 10mm, AG70-14 for valves having stem \varnothing 14mm

** valid for the following models: M6: V176A,B, V538C, 1/4": V5011A

ELECTRICAL CONNECTIONS

Remove the cover screw with a screwdriver and then remove the cover as shown in the picture beside.

The actuator is equipped with 4 removable terminal block:

- a not removable 2 poles terminal block for main power supply
- a removable 6-poles terminal block (T1) with power supply, analog and digital command signal and feedback signal; each terminal pole is clearly marked and the same label is shown on the electronic board. Before turning on the actuator, make sure that the terminal block is correctly connected to the board and that the label on the terminals and board match;
- a removable 6-poles terminal block (T2) dedicated to the RS-485 bus connection (Modbus) - (only 3 poles are used);
- a removable 6-poles terminal block (T3) dedicated to the connections of the temperature sensors (only 4 poles are used).

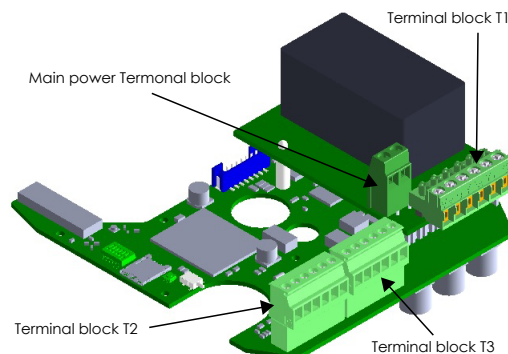
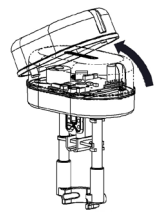

The actuator is supplied with 2 cable glands with die-cut membranes for safe wiring.

- Cable gland 1 for 3 cables: 2-wires cable for power supply; 5-wires cable for control and feedback signals and 3-wires cable for Modbus;
- Cable gland 2 for 4 cables: 2-wires cable for T1 temperature sensor, 2-wires cable for T2 temperature sensor.

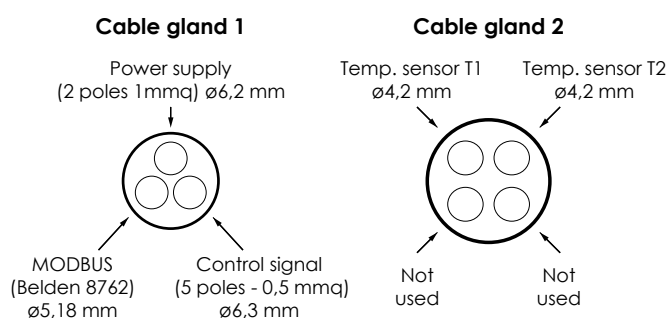

Terminal block T1

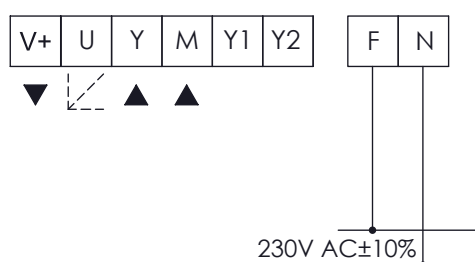

LABEL	DESCRIPTION	FUNCTION	CABLE TYPE	MAX WIRE LENGTH
F	230 V AC	Power supply	AWG 16 (min 1mm ² - max 1,5mm ²)	75 m
N				
Y	0-10 V DC	Modulating control input	AWG 20 (min 0,5mm ² - max 1,5mm ²)	200 m
M	0 V (common)			
Y1	Not used			
Y2				
V+	16 V DC	Voltage output max 25 mA	AWG 20 (min 0,5mm ² - max 1,5mm ²)	200 m
M	0 V (common)			
U	2-10 V DC	Feedback output signal	AWG 20 (min 0,5mm ² - max 1,5mm ²)	200 m
M	0 V (common)			

Terminal block T2

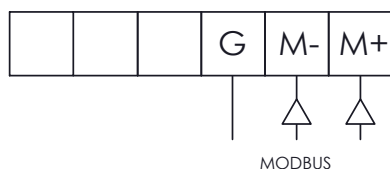

LABEL	DESCRIPTION	FUNCTION	CABLE TYPE	MAX WIRE LENGTH
M+	Tx	Modbus connection	Belden 8762	See chapter Modbus – RS485
M-	Rx			
G	Shield			

Terminal block T3

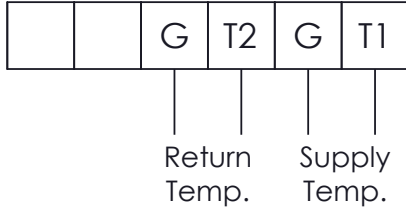

LABEL	DESCRIPTION	FUNCTION	MAX WIRE LENGTH
T1	Supply temp. sensor	Temperature control loop and ΔT limit function	10 m
G	Common		
T2	Return temp. sensor		
G	Common		

Wiring diagrams

Modbus control

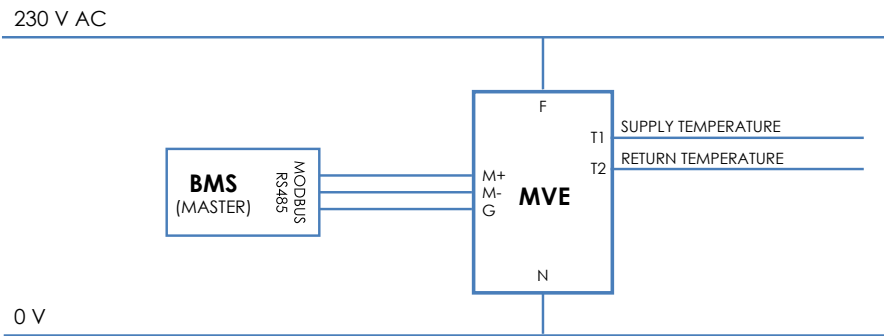

Modulating Control & Modbus Supervisory

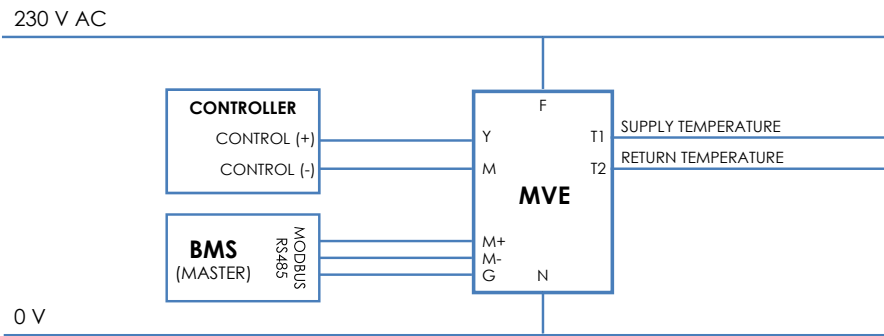

Modbus - RS485 connection

RS485 network is made with a 3-conductor cable, which will be recognized below with “+” (M+), “-” (M-) and “GND” (pin G). For wiring, we recommend the Belden® cable, model 8762. In particularly “noisy” environments, we recommend the Belden® cable, model 3106A connecting the twisted pair respectively to the “+” and “-” signals, the reference conductor to GND and the screen on the ground.

Alternatively, a cable with the following electrical and mechanical characteristics can be used:

- AWG 20/22;
- characteristic impedance of 120Ω;
- with copper conductors, of the “braid” type, twisted;
- with braided shielding and protective insulation.

The shield must be connected to the GND signal (pin 25) of the actuator.

The network must only be wired according to the following principle, defined as a “daisy chain” (the device consists of a single RS485 port). Star connections are not allowed.

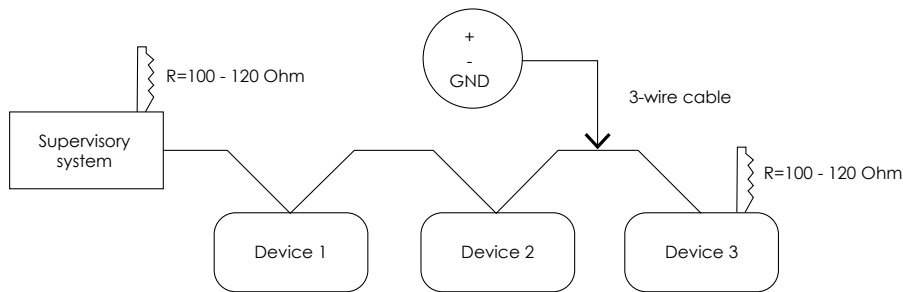

Connection warnings

For correct wiring of the network it is recommended to respect the following warnings:

1. Do not use different types of cable to create the same network, but always and only use the same type of cable;
2. The network cable is crossed by SELV safety voltage signals and must not be wired in channels intended for cables with dangerous voltages (for example 230 V AC) or carriers of high currents, especially if in alternating current. Also avoid parallel paths to these power cables;
3. Wire the cable as straight as possible, avoiding folds with tight bending radius, let alone wrapping it in unnecessary charges;
4. Do not twist the cable around power conductors and, if you have to cross them, provide a 90 ° cross between the cable and these conductors;
5. Keep away from electromagnetic field sources, in particular from large motors, switchboards, neon ballasts, antennas of all types;
6. Avoid that the pull tension of the cables exceeds 110N (11.3 kg) to prevent ironing;
7. Evaluate the route in advance so as to shorten it as much as possible and take note of the addresses of the instruments connected with particular reference to their location in orderly sequence. This can be very useful in maintenance; We recommend that you take note of the Modbus address and report it on the product label in the space provided for it.
8. Do not invert the polarity "+" and "-" at the connection terminals;
9. Avoid short pieces of cable in the connection terminals to the instruments, in order to allow a possible maintenance without tearing or pulling of the cable itself;
10. Identify the start and end terminations and avoid "open" segments; Termination resistors and network polarization The slew-rate control, common to all our converters, and the baud rate limited to 9600 baud (bit/sec) make termination resistors unnecessary. The RS485 network requires polarization typically borne by the Master device; the regulator does not have polarization resistors. The transceiver used by the actuator allows to drive up to 256 knots.

The RS485 standards provide for a maximum length of 1200 m and/or 32 devices on the network. However, it should be noted that the more the "standard" limits are exceeded (maximum limit of 32 devices or cable lengths greater than 1200 m), the higher the probability that communication problems will arise. The phenomenon is not systematic and may not even occur.

Vice versa, if it occurs, and none of the points indicated in this paragraph has allowed to solve the problem, the connection of a repeater (code CONV-RS485-RIP) is suggested, as shown in the figure below:

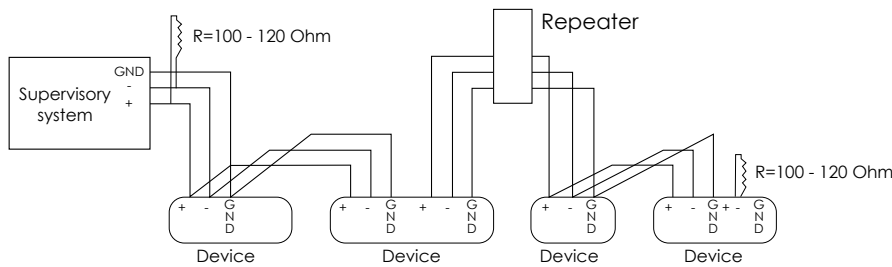

NOTE - Use a repeater if the cable length exceeds 1200 m or if there are more than 32 devices.

DIPSWITCH SETTING

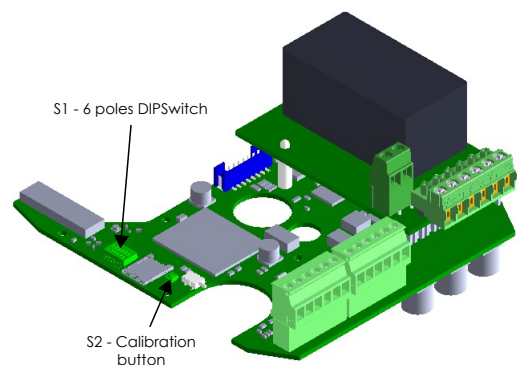
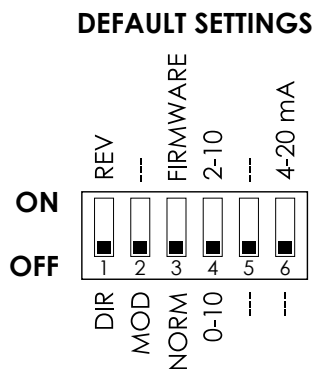

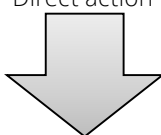
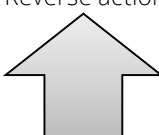
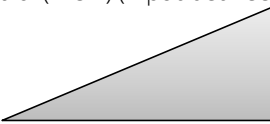
DIP SWITCH	OFF	ON
1	<p>Direct action</p>  <p>U = feedback</p> <p>U = 2V</p> <p>U = 10V</p>	<p>Reverse action</p>  <p>U = feedback</p> <p>U = 10V</p> <p>U = 2V</p>
2	<p>Modulating Control (MOD) (Input between Y [+] and M [-])</p> 	Not used
3	-	Enter in bootloader (Firmware download)
4	Modulating Control 0-10 V DC (DIP n. 2 OFF only)	Modulating Control 2-10 V DC (DIP n. 2 OFF only)
5	Not used	Not used
6	Voltage Input Signal (input between Y [+] and M [-])	Current Input Signal 4-20mA (input between Y [+] and M [-])

DIAGNOSTIC - ALARM FUNCTIONS

N°	ERROR TYPE	ACTUATOR STATUS	ACTUATOR BEHAVIOR	NOTIFICATION TYPE	POSSIBLE ANOMALY	RESTORE PROCEDURE
				LEDS		
1	Stroke less than 5 mm	Calibration / first installation	The actuator returns to its initial position and does not respond to the command. The actuator keeps the previous stroke or the default stroke	RED ON	Valve with stroke less than 5 mm	Remove power and re-power again
2	Stroke greater than 60 mm	Calibration / first installation	The actuator leaves the maximum range of 60mm and moves to the new extreme. Once the new stroke limit is reached, it returns to the initial position signaling an anomaly. The actuator does not learn the new stroke.	RED fast blinking + GREEN ON	Valve with stroke greater than 60 mm or incorrect coupling	Remove power and re-power again
3	Unexpected collision within the stroke	Normal operation	The actuator checks the stall condition 5 times. At the end of the attempts it signals an anomaly. The actuator does NOT learn the new stroke, but after 60s repeats the attempts to check the blocking conditions	RED fast blinking	Valve blocked	Reverse the control signal
4	Stroke greater than expected	Normal operation	The actuator moves to the new crash position with low speed signaling an anomaly. The actuator does NOT learn the new stroke	RED fast blinking	Damaged valve or incorrect coupling	Reverse the control signal
5	Low supply voltage	Normal operation	The actuator continues to operate but performance is not guaranteed. If the low voltage events persist (events greater than 10), the actuator stops working.	RED blinking alternately fast (5sec) and slow (5sec) + GREEN ON	1. Wrong sizing of transformer 2. Unstable power supply	Check and restore power
6	High supply voltage	Normal operation	The actuator continues to operate but performance is not guaranteed. If the high voltage events persist (events greater than 10), the actuator stops working.	RED slow blinking	1. Wrong sizing of transformer 2. Unstable power supply	Check and restore power
7	Temperature sensors error	Normal operation	Temperature or ΔT control loops not working	RED blinking alternately fast (5sec) and slow (5sec) + GREEN ON	1. Incorrect temperature probe connection 2. Temperature probes damaged 3. Temperature detected outside the range of use	Check the connection and the condition of the temperature sensor

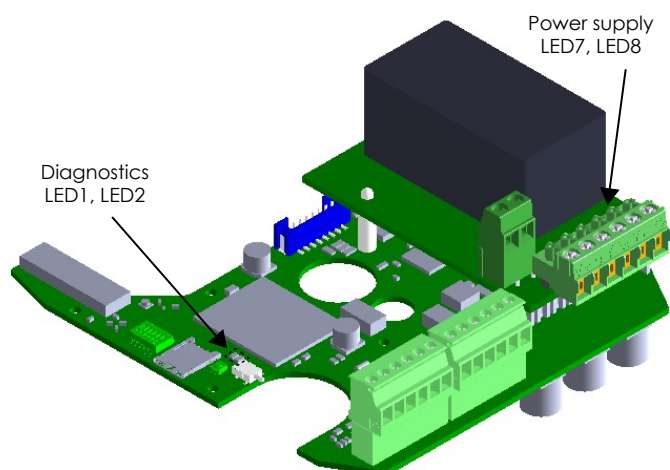

N°	LED 1 AND 2	ACTUATOR STATUS
1	FIXED GREEN	Actuator at end point of the calibrated stroke
2	GREEN SLOW BLINKING	Actuator has arrived or is moving towards an intermediate point of the calibrated stroke
3	RED and GREEN BLINKING ALTERNATIVELY	Actuator is calibrating the stroke or performing the initial positioning
4	RED and GREEN FIXED	Manual control activated, the actuator ignores the control signal. WARNING! The board is powered

N°	LED 7 (RED) AND 8 (RED)	ACTUATOR STATUS
1	LED 7 RED ON; LED 8 RED ON	Stable power supply of the actuator
2	LED 7 RED ON; LED 8 OFF	Unstable actuator power supply; possible hardware problem

DIMENSIONS [mm]

MVE2xx-2-RS

