

Frese OPTIMA Compact DN10-DN50 Pressure Independent Balancing & Control Valve

Application

Frese OPTIMA Compact pressure independent balancing & control valve (PIBCV) is used in heating and cooling systems in applications with Fan Coil Units, Chilled Beams or other terminal unit applications.

Frese OPTIMA Compact provides modulating control with full authority regardless of any fluctuations in the differential pressure of the system.

Frese OPTIMA Compact combines an externally adjustable automatic balancing valve, a differential pressure control valve and a full authority modulating control valve.

Frese OPTIMA Compact makes it simple to achieve 100% control of the water flow in the building, while creating high comfort and energy savings at the same time.

An additional benefit is that no balancing is required if further stages are added to the system, or if the dimensioned capacity is changed.

Energy saving due to optimal control, lower flow and pump pressure. Maximized ΔT due to faster response and increased system stability.

Benefits

Design

- Less time to define the necessary equipment for a hydraulic balanced system (only flow data are required)
- No need to calculate valve authority. Always one.
- Flexibility if the system is modified after the initial installation

Installation

- No further regulating valves required in the distribution pipework when Frese OPTIMA Compact is installed at terminals.
- Total number of valves minimized due to the 3-in-1 design
- Minimized commissioning time due to automatic balancing of the system
- No minimum straight pipe lengths required before or after the valve.

Operation

- High comfort for the end-users due to high precision temperature control
- Longer life due to less movements of the actuator



Features

- The presetting function has no impact on the stroke; Full stroke modulation at all times, regardless the preset flow.
- The constant differential pressure across the modulating control component guarantees 100% authority.
- Automatic balancing eliminates overflows, regardless of fluctuating pressure conditions in the system.
- Thermic actuator On/Off or 0-10V, normally closed.
- Motoric actuator 0-10V, (Linear or Logarithmic) or 3 point control.
- Differential pressure operating range up to 800 kPa
- High flows with minimal required differential pressure due to advanced design of the valve
- Small dimensions due to compact housing
- Higher presetting precision due to stepless analogue scale
- Rangeability > 100:1

Frese OPTIMA Compact DN10-DN50 Pressure Independent Balancing & Control Valve

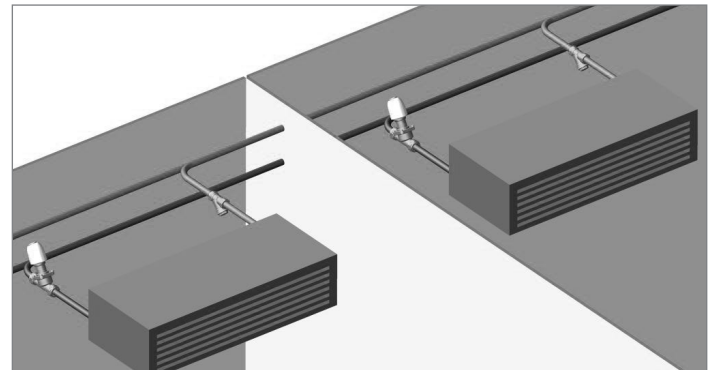
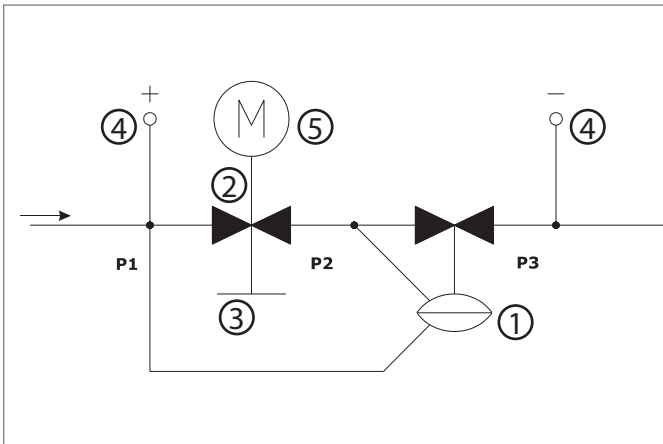

Function

Frese OPTIMA Compact can be flushed and commissioned before the actuator is installed.

The presetting of the dial is user-friendly requiring only a simple flow vs. presetting graph. Once the flow is set, the actuator can be mounted and the valve ready to operate.

For lowest energy consumption, check the differential pressure at the index valve to set the pump at minimum speed.

Operating Pressure

The Frese OPTIMA Compact (DN10 to DN50) can operate to a maximum differential pressure of 800 kPa (8 bar)

Close Off Pressure

The Frese OPTIMA Compact is capable of closing against the following differential pressures to EN 1349 Class IV:

- DN10 to DN25: 600 kPa (6 bar) - based on 100N actuator force
- DN10 to DN25: 800 kPa (8 bar) - based on 160N actuator force
- DN25L to DN32: 800 kPa (8 bar) - based on 100N actuator force
- DN40 to DN50: 800 kPa (8 bar) - based on 400N actuator force

Isolation

When fitted with the isolation cap (DN10 to DN32 only), the Frese OPTIMA Compact is capable of isolation to 10 bar.

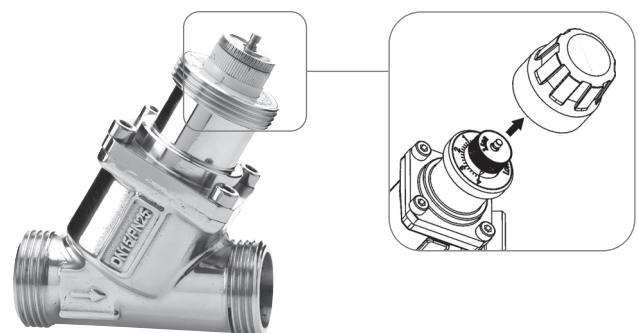

Design

The design of Frese OPTIMA Compact combines high performance with small size and compact construction. The main components of the valve are:

- ① Differential pressure control
- ② Modulating control component
- ③ Presetting scale (not accessible when the actuator is mounted)
 - a) Flow range: Low-High
 - b) Stroke: 2,5 - 5,0 - 5,5mm
- ④ P/T Plugs (Optional)
- ⑤ Actuator

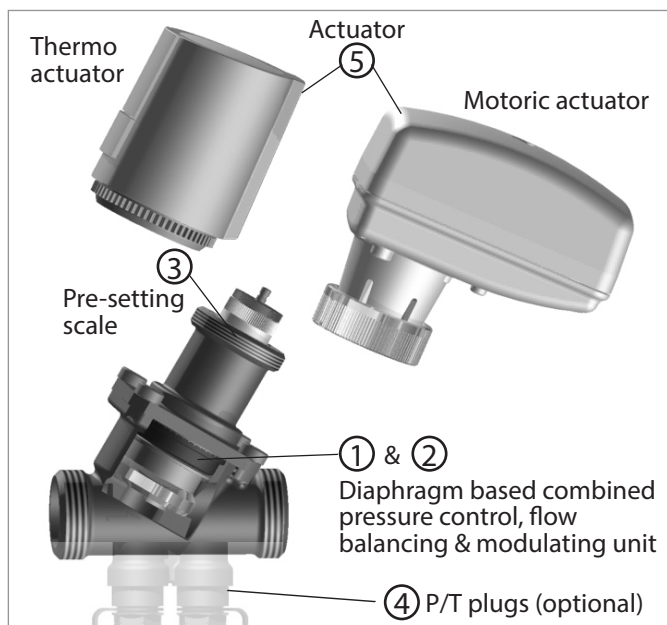
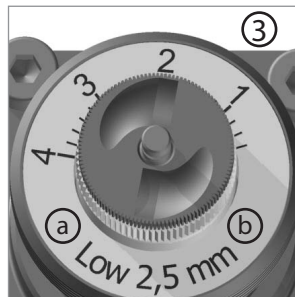

Frese OPTIMA Compact DN10-DN50 Pressure Independent Balancing & Control Valve

Operation principle

The innovative design of Frese OPTIMA Compact features a modulating control component that retains 100% authority at all times.

With the Frese OPTIMA Compact, there are two independent movements for the presetting and the modulating function. During presetting, the inlet area moves radially without interfering with the length of the stroke. During modulating, the inlet area moves axial taking advantage of the full stroke.

Whilst the control component provides proportional modulation irrespective of the preset flow, the automatic balancing guarantees that the flow will never exceed the maximum preset flow.

Regardless of pressure fluctuations in the system, the maximum flow is kept constant up to a maximum differential pressure of 800 kPa.

Flow rate vs. Differential Pressure

Preset flow: 300 l/h, 150 l/h

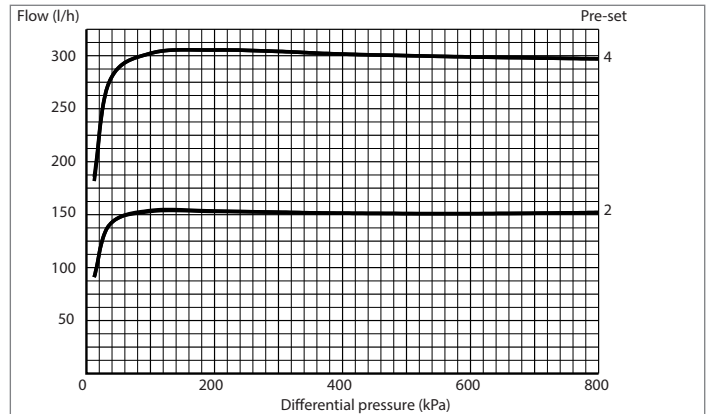

Flow rate vs. Voltage

Preset flow: 200 l/h

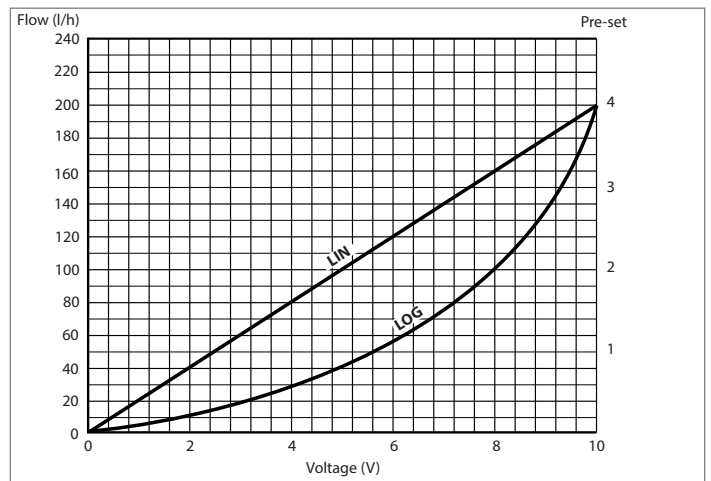

Flow rate vs. Differential Pressure

Voltage: 10V, 7V, 3V

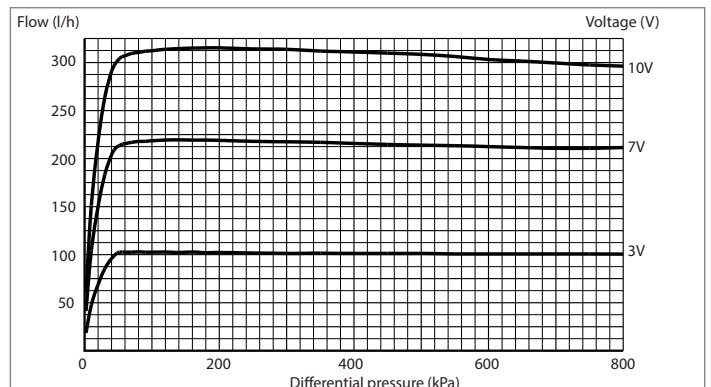

Frese OPTIMA Compact DN10-DN50 Pressure Independent Balancing & Control Valve

Technical data

Valve housing:

DN10-15-20-25-32

DZR Brass

DN40-50

Ductile Iron

DP controller:

PPS 40% glass

Spring:

Stainless steel

Diaphragm:

HNBR

O-rings:

EPDM

Pressure class:

PN25

Max. differential pressure:

800 kPa

Needles for DP measurement:

Max diameter, $\varnothing 3.2$ mm
Length, 25 - 40 mm

Thread:

ISO 228

Medium temperature range:

-10°C to 120°C

When used at temperatures below 0°C, a stem heater must be used, to prevent ice on the spindle

The pipe system shall be properly ventilated to avoid risk of air pockets. Glycolic mixtures up to 50% are applicable (both ethylene and propylene).
Recommendation: Water treatment to VDI 2035.
Frese A/S can accept no responsibility if another actuator is used instead of the Frese actuator.

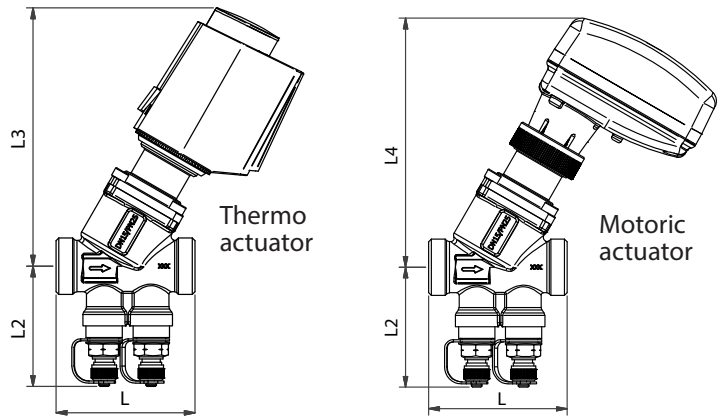
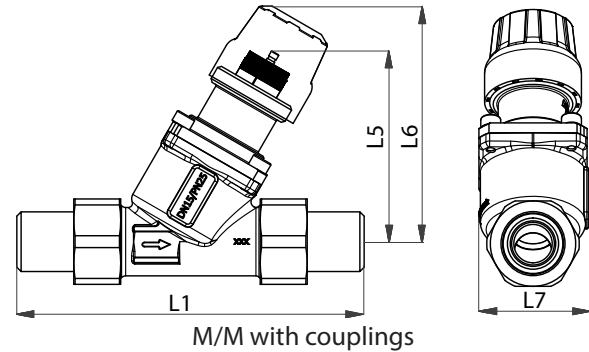

Dimension & Weight

Dim.		DN10	DN15		DN20		DN25/DN25L		DN32		DN40	DN50
Thread		M/M G 1/2	M/M G 3/4	F/F G 1/2	M/M G 1	F/F G 3/4	M/M G 1-1/4	F/F G 1	M/M G 1-1/2	F/F G 1-1/4	F/F G 1-1/2	F/F G 2
Length	L	65	65	75	70	79	78/104	83/100	104	104	138	138
	L1	114	122	-	131	-	-	-	-	-	-	-
	L2	57	57	57	57	57	59/63	59/63	68	68	71	77
	L3	121	121	121	121	121	124/139	124/139	139	139	-	-
	L4	117	117	117	117	117	120/135	120/135	135	135	264	264
	L5	68	68	68	68	68	68/85	68/85	85	85	143	143
	L6	83	83	83	83	83	83/100	83/100	100	100	-	-
Weight kg	L7	38	38	38	38	38	38/63	38/63	63	63	90	90
	Basic	0.36	0.38	0.42	0.40	0.45	0.51/1.02	0.55/1.04	1.17	1.17	-	-
	P/T	0.45	0.47	0.52	0.50	0.54	0.62/1.12	0.65/1.14	1.27	1.27	3.28	3.71

Flow

Dim.		DN10 - DN15		DN15 - DN20		DN20	DN25	DN25L	DN32	DN40	DN50
Type		Low		High		High	Low	High	-	-	-
Stroke	mm	2.5	5.0	2.5	5.0	5.5	5.5	5.5	5.5	15	15
Flow	l/h	30 - 200	65 - 370	100 - 575	220 - 1,330	300-1,800	280-1,800	600-3,609	550-4,001	1,370-9,500	1,400-11,500
	l/s	0.008-0.056	0.018-0.103	0.028-0.160	0.061-0.369	0.083-0.500	0.078-0.500	0.167-1.003	0.153-1.111	0.381-2.639	0.389-3.194
	gpm	0.13 - 0.88	0.29 - 1.63	0.44 - 2.53	0.97 - 5.85	1.32-7.93	1.23-7.93	2.64-15.89	2.42-17.62	6.03-41.83	6.16-50.63

Frese OPTIMA Compact DN10-DN50 Pressure Independent Balancing & Control Valve

Technical data actuators DN 10-15-20-25-32

Characteristics:	Thermic, normally closed
Protection class:	IP 54 to EN 60529
Frequency AC:	50/60 Hz
Control signal:	0-10V AC/DC or On/Off
Actuating force:	100 N
Stroke:	2.5 - 5.0 - 5.5 mm
Running time:	30 s/mm 0-10V/180 s On/Off
Ambient operating conditions:	0°C to 60°C
Cable length:	1.0 m
Weight:	100 g

On/Off actuator 2.5 mm stroke, 24V AC/DC/ On/Off 180s	48-5525
On/Off actuator 2.5 mm stroke 230V AC/ On/Off 180s	48-5526
On/Off actuator 5.0-5.5 mm stroke, 24V AC/DC/ On/Off 180s	48-5527
On/Off actuator 5.0-5.5 mm stroke 230V AC/ On/Off 180s	48-5528
Modulating actuator 2.5-5.0-5.5 mm stroke 24V AC/0-10V DC 30 s/mm	48-5529

Characteristics:	Motoric, modulating
Protection class:	IP 43 to EN 60529
Frequency AC:	50/60 Hz
Control signal:	0-10V DC or 3 position
Actuating force:	120 N
Stroke max:	5.5 mm (Dip switch setting 2.5-5.0-5.5mm)
Running time 5.5 mm:	75 s 0-10V / 150 s 3-pos
Ambient operating conditions:	+1°C to 50°C
Cable length:	1.5 m
Weight:	215 g

Modulating actuator 5.0 - 5.5 mm, 24V AC/DC/ 0-10V DC/ 8 s/mm	53-1180
Modulating actuator 2.5 - 5.0 - 5.5 mm, 24 V AC/ 3 pos / 13 s/mm	53-1181
Modulating actuator 2.5 - 5.0 - 5.5 mm, 230 V AC/ 3 pos. / 13 s/mm	53-1182
Modulating actuator 2.5 mm, 24V AC/DC/ 0-10V DC/ 8 s/mm	53-1183



Technical data actuator DN 40-50 - actuator included with the valve

Characteristics:	Motoric, modulating
Protection class:	IP 54 to EN 60529
Frequency AC:	50/60 Hz
Supply voltage:	24V AC/DC
Control signal:	0-10V DC or 3 position
Actuating force:	400 N
Stroke max:	32 mm, selfcalibrating
Running time:	60 s
Ambient operating conditions:	-10°C to 50°C
Manual operation:	Manual handle
Cable:	Not included
Weight:	1.80 kg



Frese OPTIMA Compact DN10-DN50 Pressure Independent Balancing & Control Valve

Actuator requirements DN 10-15-20-25-32

Dimension "X" in closed position
 2.5 mm stroke = 11.4 mm
 5.0 mm stroke = 9.3 mm
 5.5 mm stroke = 8.8 mm

Actuator minimum force: 100N

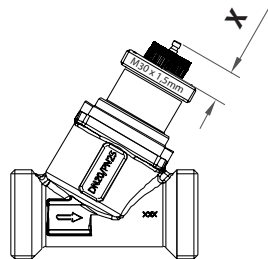

Actuator connection: M30 x 1,5mm





Combination matrix: Frese OPTIMA Compact DN10-15-20-25-32 / Actuators

Frese OPTIMA Compact can be combined with both Thermo actuators and Motoric actuators.

The design of the valve, combined with the Frese actuator, produces a perfect control characteristic that utilises the full control range of the system.

Thermo Actuators				Motoric Actuators			
							
On/Off				0....10V		3-pos	

Male/Male ISO 228	Type	Stroke	Flow l/h	Dim	24 V	230V	24V	230V	24V	24V	24V	230V
					2,5mm	2,5mm	5,0 - 5,5mm	5,0 - 5,5mm	2,5 - 5,0 - 5,5 mm	2,5 mm		
	DN10 M/M LOW 2.5	2.5	30-200	DN10	●	●			●	●	●	●
	DN10 M/M LOW 5.0	5.0	65-370	DN10			●	●	●		●	●
	DN15 M/M LOW 2.5	2.5	30-200	DN15	●	●			●	●	●	●
	DN15 M/M LOW 5.0	5.0	65-370	DN15			●	●	●		●	●
	DN15 M/M HIGH 2.5	2.5	100-575	DN15	●	●			●	●	●	●
	DN15 M/M HIGH 5.0	5.0	220-1330	DN15			●	●	●		●	●
	DN20 M/M HIGH 2.5	2.5	100-575	DN20	●	●			●	●	●	●
	DN20 M/M HIGH 5.0	5.0	220-1330	DN20			●	●	●		●	●
	DN20 M/M HIGH 5.5	5.5	300-1800	DN20			●	●	●		●	●
	DN25 M/M LOW 5.5	5.5	280-1800	DN25			●	●	●		●	●
	DN25L M/M HIGH 5.5	5.5	600-3609	DN25			●	●	●		●	●
DN32 M/M 5.5	5.5	550-4001	DN32			●	●	●		●	●	
Female/Female ISO 228	Type	Stroke	Flow l/h	Dim								
	DN15 F/F LOW 2.5	2.5	30-200	DN15	●	●			●	●	●	●
	DN15 F/F LOW 5.0	5.0	65-370	DN15			●	●	●		●	●
	DN15 F/F HIGH 2.5	2.5	100-575	DN15	●	●			●	●	●	●
	DN15 F/F HIGH 5.0	5.0	220-1330	DN15			●	●	●		●	●
	DN20 F/F HIGH 2.5	2.5	100-575	DN20	●	●			●	●	●	●
	DN20 F/F HIGH 5.0	5.0	220-1330	DN20			●	●	●		●	●
	DN20 F/F HIGH 5.5	5.5	300-1800	DN20			●	●	●		●	●
	DN25 F/F LOW 5.5	5.5	280-1800	DN25			●	●	●		●	●
	DN25L F/F HIGH 5.5	5.5	600-3609	DN25			●	●	●		●	●
	DN32 F/F 5.5	5.5	550-4001	DN32			●	●	●		●	●





Frese OPTIMA Compact DN10-DN50 Pressure Independent Balancing & Control Valve

Types and operation data actuator DN40-DN50

Type	Valve Dimension	Function	Supply voltage	Power Consumption
Type-01	DN40-DN50	0-10 V / 3-pos	24 V AC +/-25% 24V DC +/- 10%	6 VA (*30VA)

*) Max consumption - for transformer sizing

Product programme

Dim.	Type	Flow l/h	Flow l/s				
				M/M	M/M, PT plugs	F/F	F/F, PT plugs
DN10	Low 2.5 mm	30-200	0.008-0.056	53-1300	53-1320	-	-
	Low 5.0 mm	65-370	0.018-0.103	53-1309	53-1329	-	-
DN15	Low 2.5 mm	30-200	0.008-0.056	53-1302	53-1322	53-1342	53-1362
	Low 5.0 mm	65-370	0.018-0.103	53-1310	53-1330	53-1350	53-1370
	High 2.5 mm	100-575	0.028-0.160	53-1304	53-1324	53-1344	53-1364
	High 5.0 mm	220-1,330	0.061-0.369	53-1305	53-1325	53-1345	53-1365
DN20	High 2.5 mm	100-575	0.028-0.160	53-1312	53-1332	53-1352	53-1372
	High 5.0 mm	220-1,330	0.061-0.369	53-1308	53-1328	53-1348	53-1368
	High 5.5 mm	300-1,800	0.083-0.500	53-1311	53-1331	53-1318	53-1338
DN25	Low 5.5 mm	280-1,800	0.078-0.500	53-1317	53-1337	53-1319	53-1339
DN25L	High 5.5 mm	600-3,609	0.167-1.003	53-1313	53-1333	53-1353	53-1373
DN32	5.5 mm	550-4,001	0.153-1.111	53-1314	53-1334	53-1354	53-1374
DN40	15 mm	1,370-9,500	0.381-2.639	-	-	-	53-1375-01
DN50	15 mm	1,400-11,500	0.389-3.194	-	-	-	53-1376-01

Accessories

	Frese no.	Product	Dimension	Thread	Material
	43-1330	Couplings 2 pcs, incl gasket	DN10	G 1/2 - R3/8	DZR Brass, CW602N
	43-2330		DN15	G 3/4 - R1/2	
	43-3330		DN20	G 1 - R3/4	

	Frese no.	Product	Dimension	Purpose	Material
	38-0857	Insulation	DN10-15-20	For heating applications only	EPP, Max temperature 120°C
	38-0858		DN25		
	38-0859		DN25L-32		

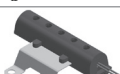
	Frese no.	Product	Type	Suitable for valves	Suitable for actuators
	58-8956	Stem Heater	24 V AC/DC, 10 W	DN10-DN32	All variants DN10- DN32
	58-8951	Stem Heater	24 VAC, 50 W	DN40-DN200	Type-01 to Type-07

Frese OPTIMA Compact DN10-DN50 Pressure Independent Balancing & Control Valve

Frese OPTIMA Compact · Low 2.5 DN10/15

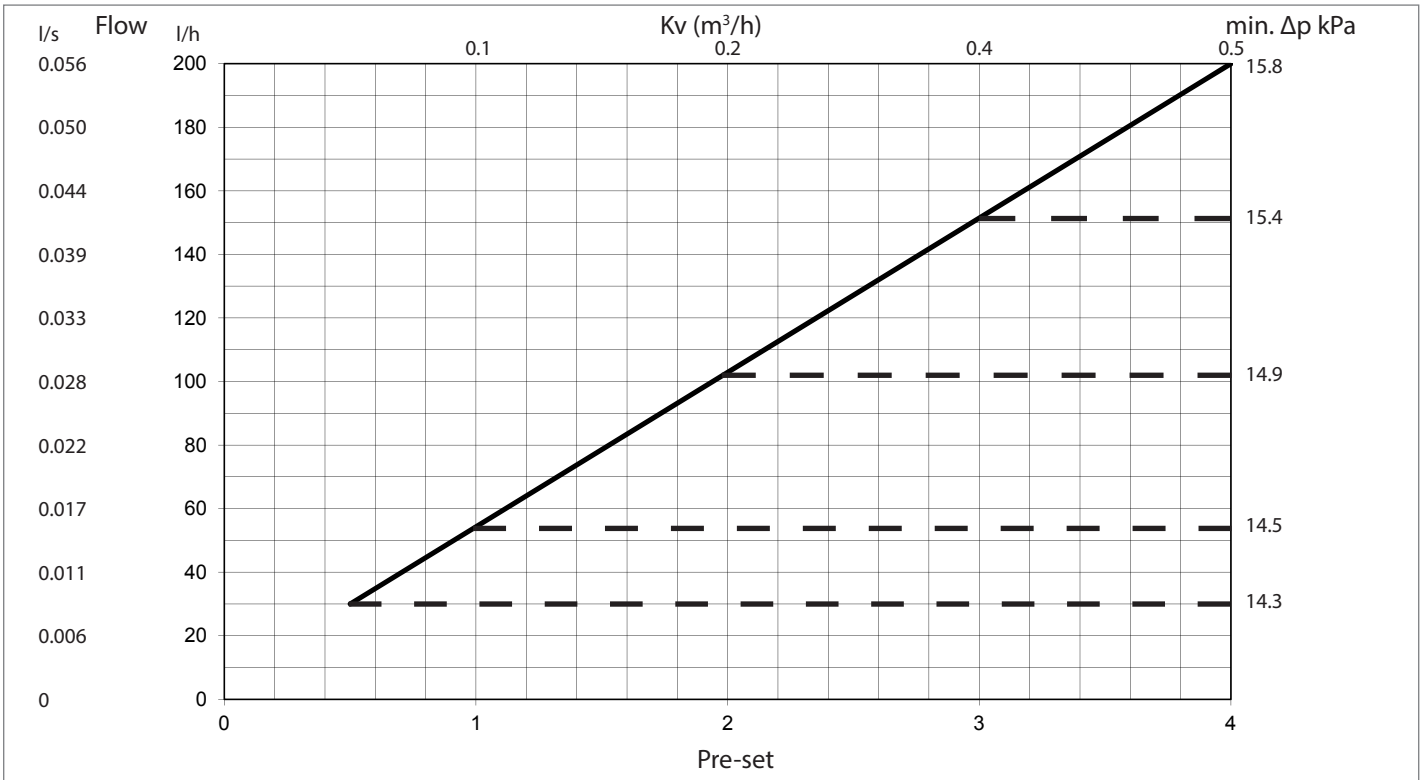

Frese OPTIMA Compact · Low 5.0 DN10/15

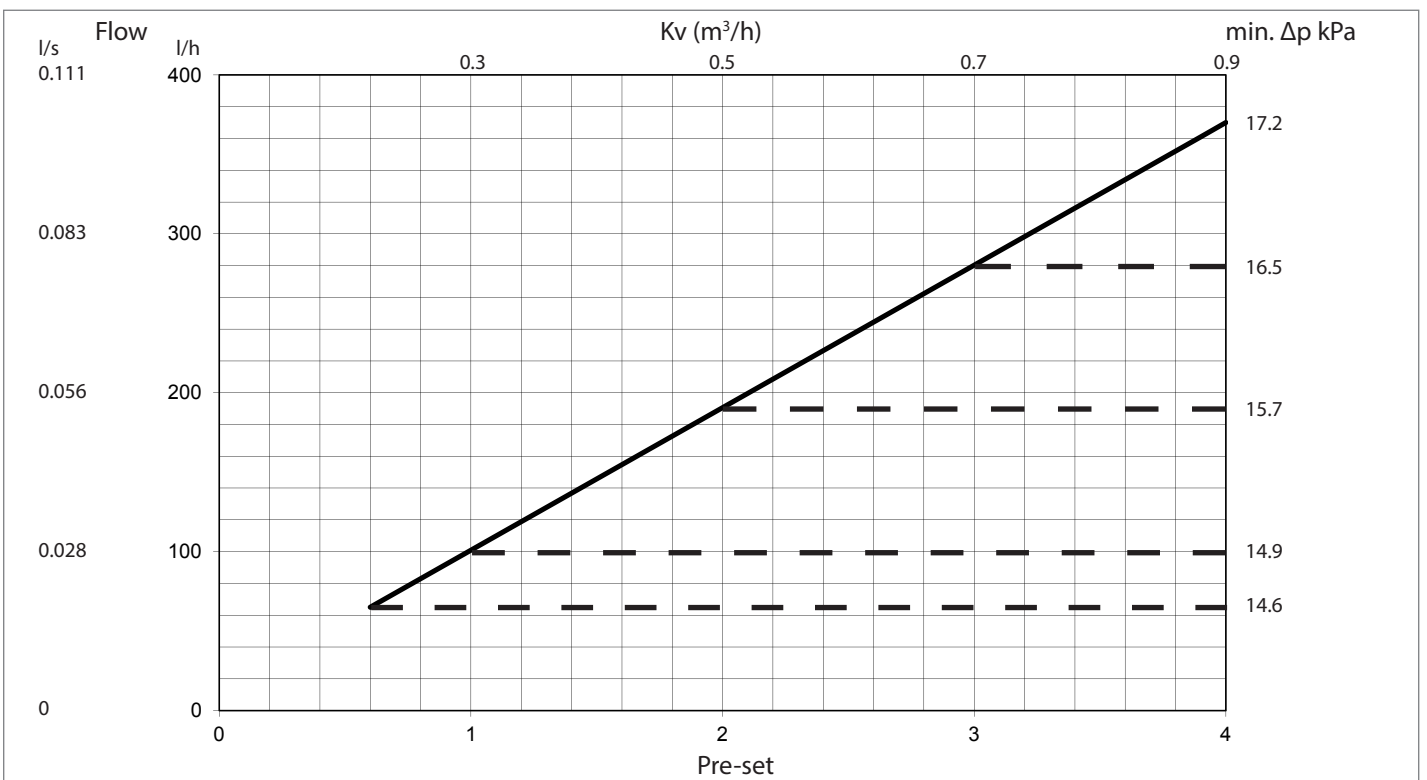

Frese OPTIMA Compact DN10-DN50 Pressure Independent Balancing & Control Valve

Frese OPTIMA Compact · High 2.5 DN15/20

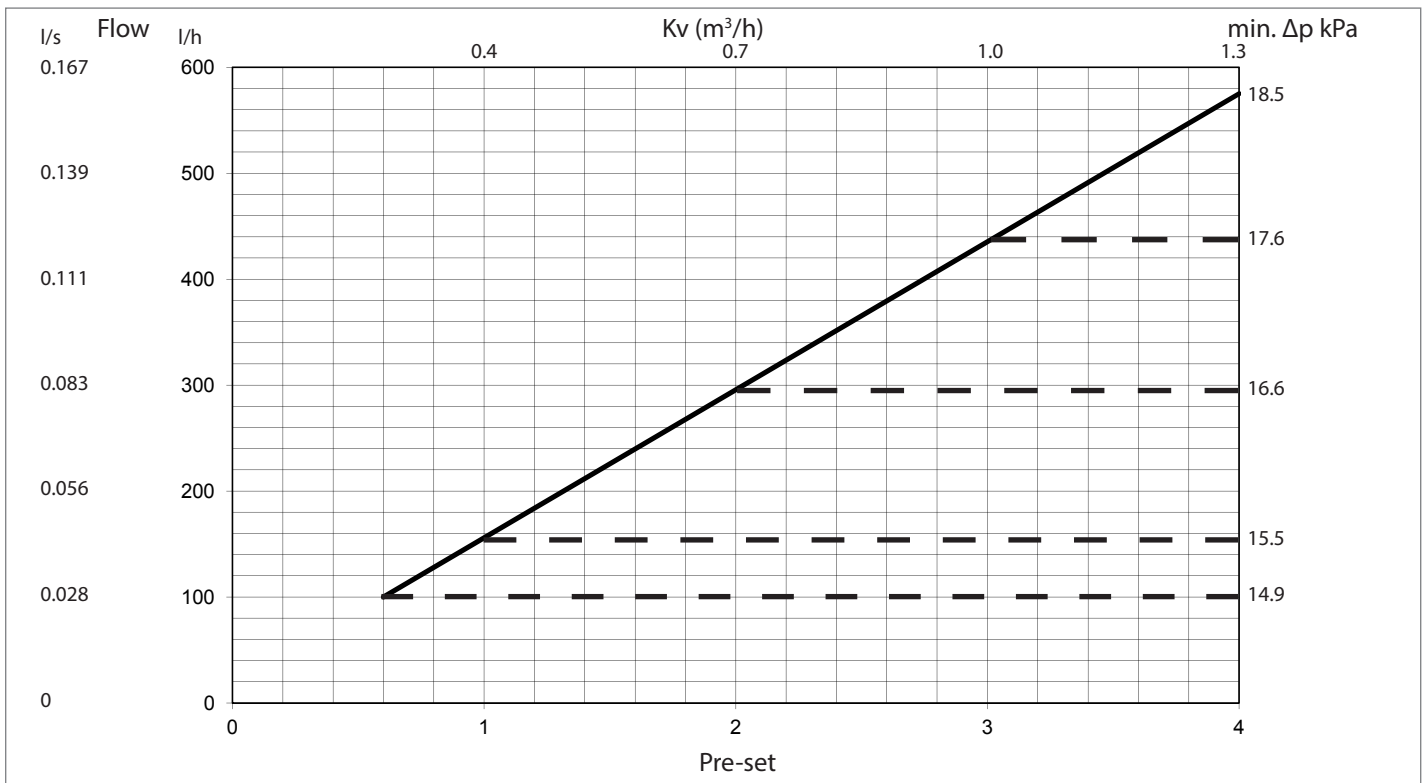

Frese OPTIMA Compact · High 5.0 DN15/20

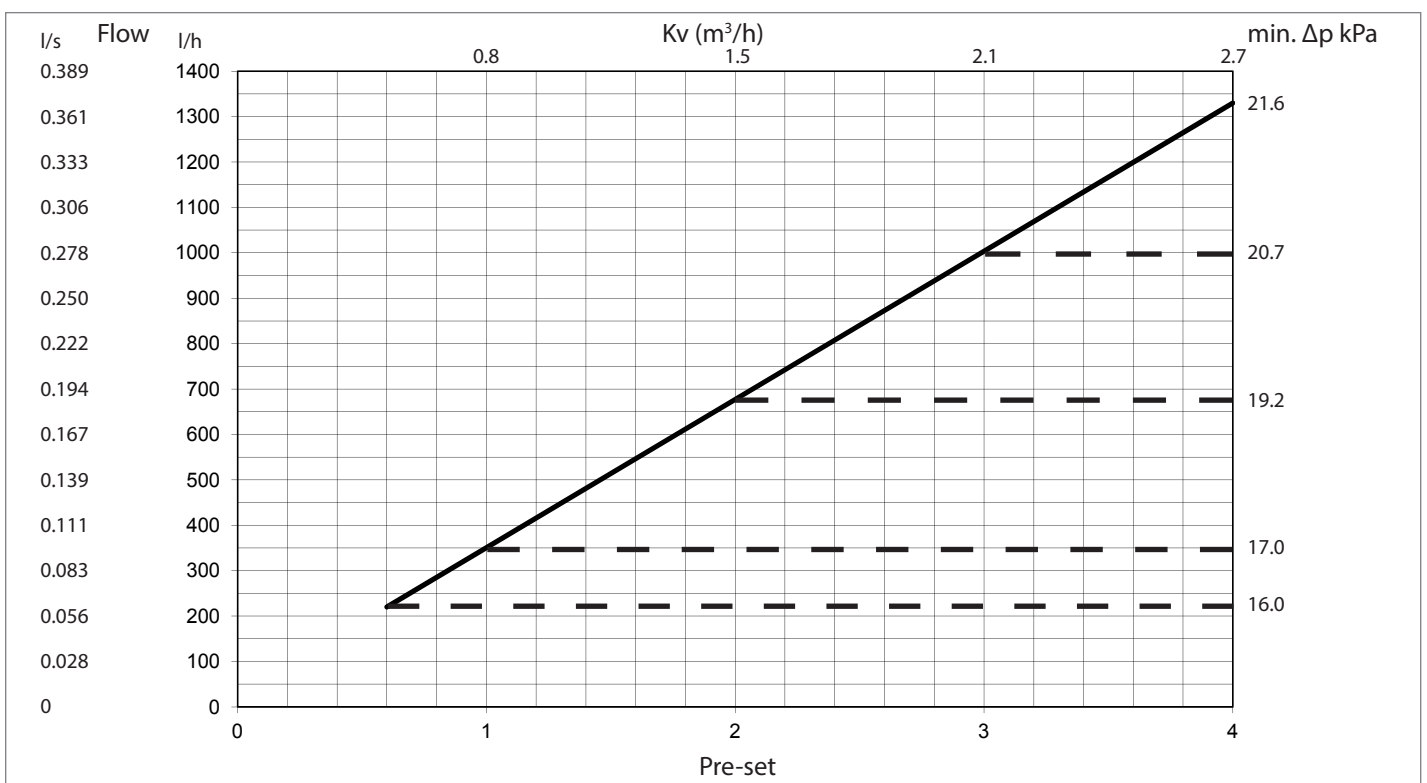

Frese OPTIMA Compact DN10-DN50 Pressure Independent Balancing & Control Valve

Frese OPTIMA Compact · High 5.5 DN20

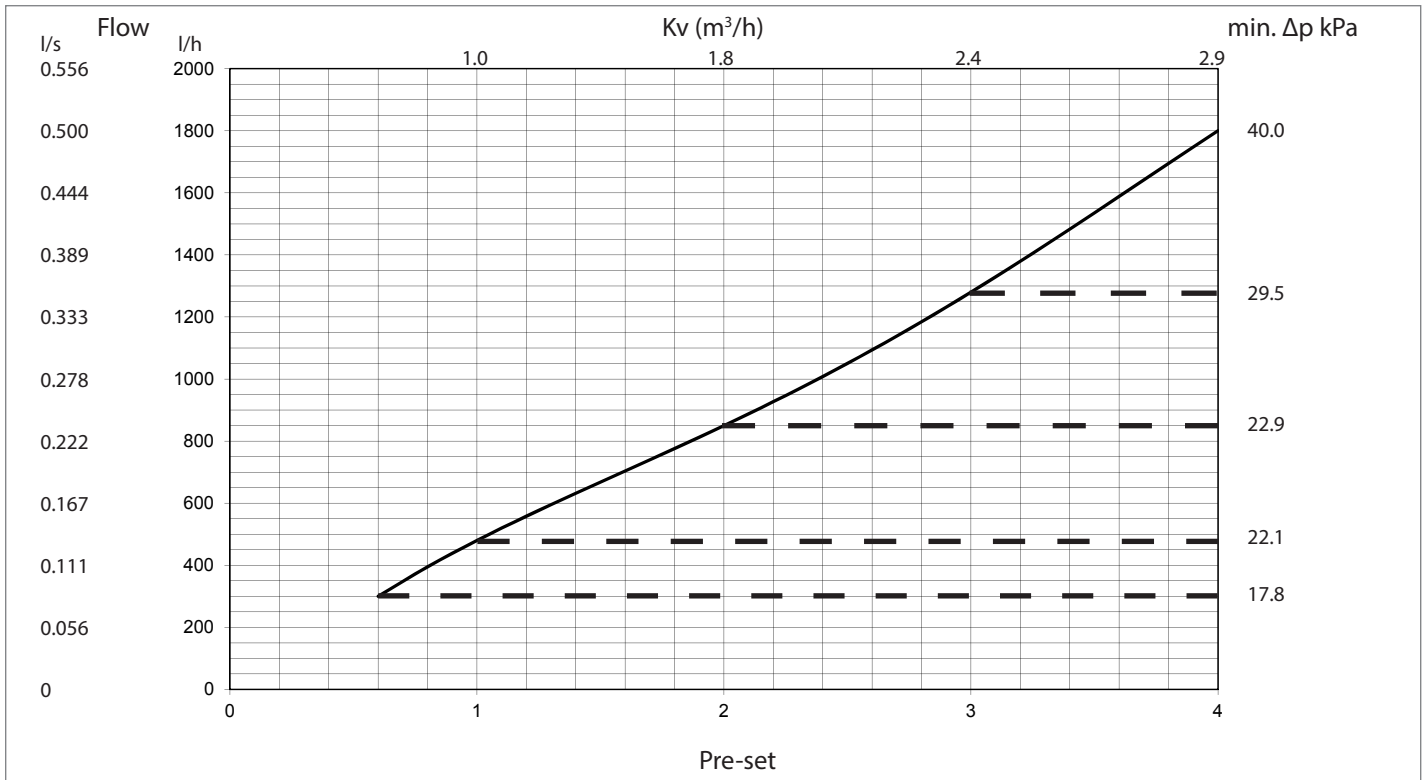

Frese OPTIMA Compact · Low 5.5 DN25

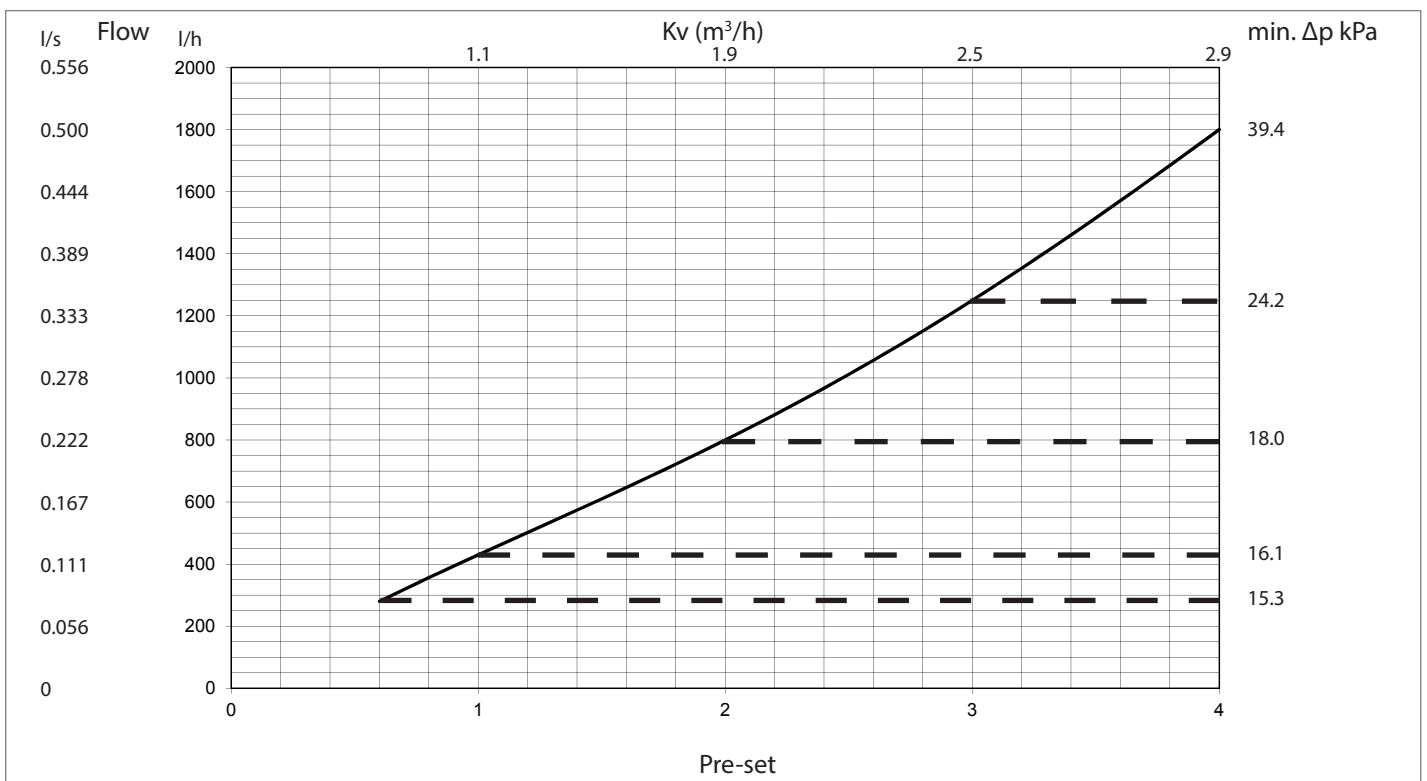

Frese OPTIMA Compact DN10-DN50 Pressure Independent Balancing & Control Valve

Frese OPTIMA Compact · High 5.5 DN25L

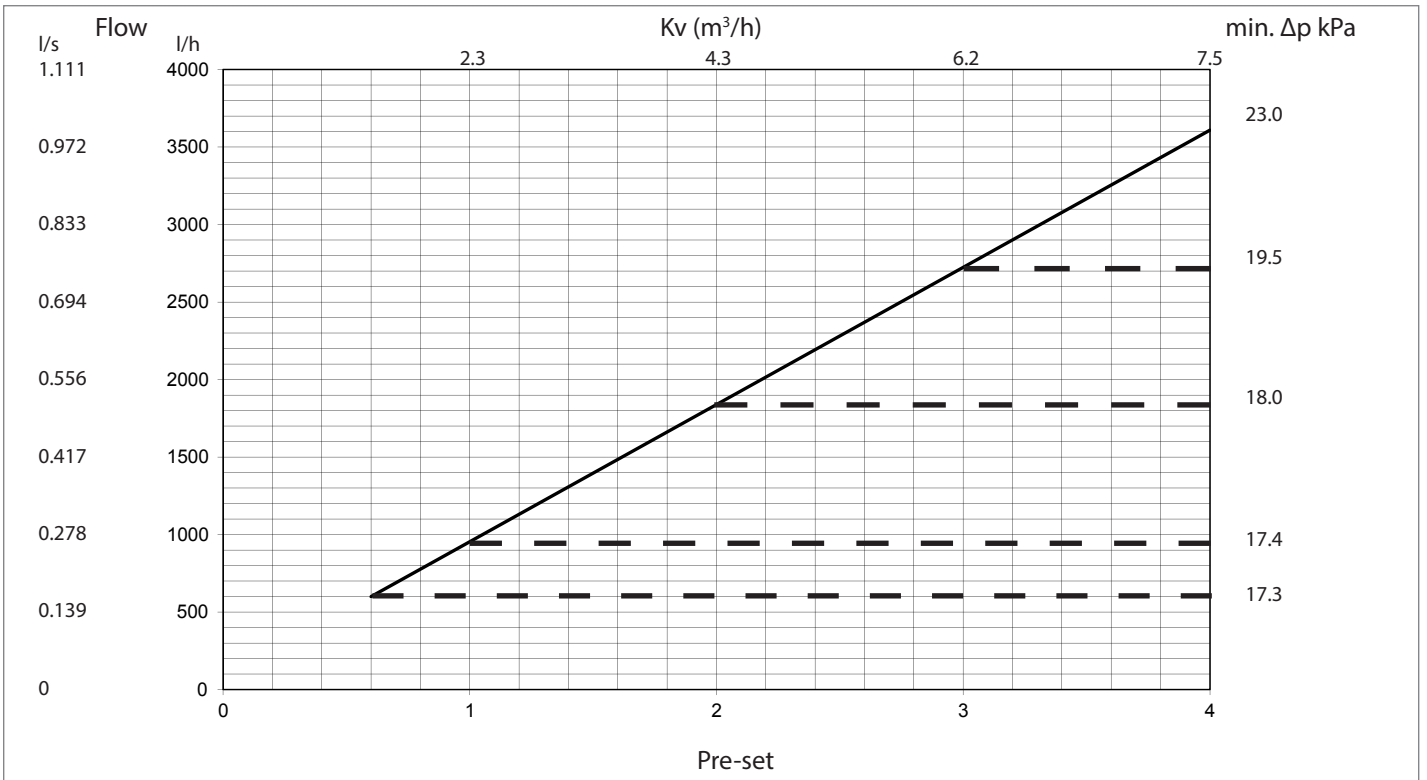

Frese OPTIMA Compact · DN32

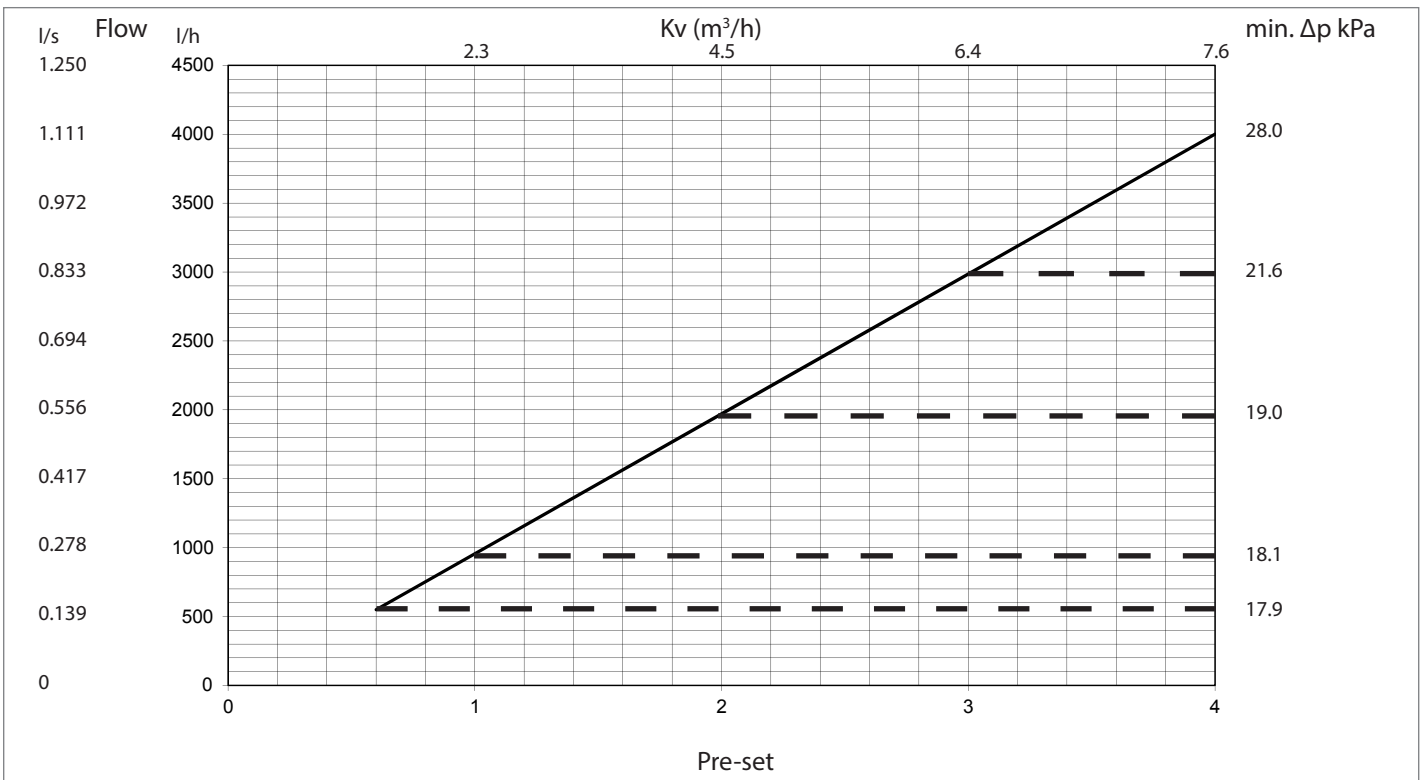

Frese OPTIMA Compact DN10-DN50 Pressure Independent Balancing & Control Valve

Frese OPTIMA Compact · DN40

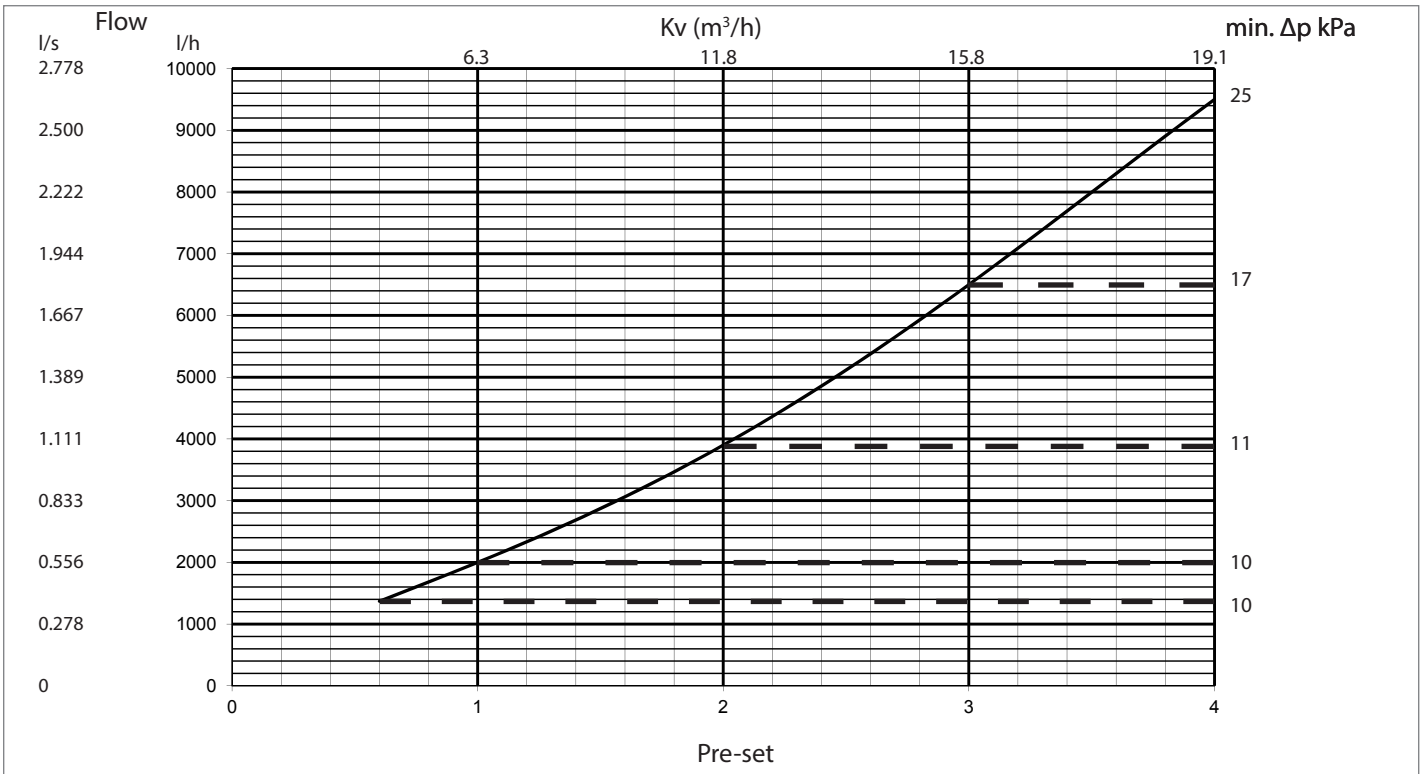

Frese OPTIMA Compact · DN50

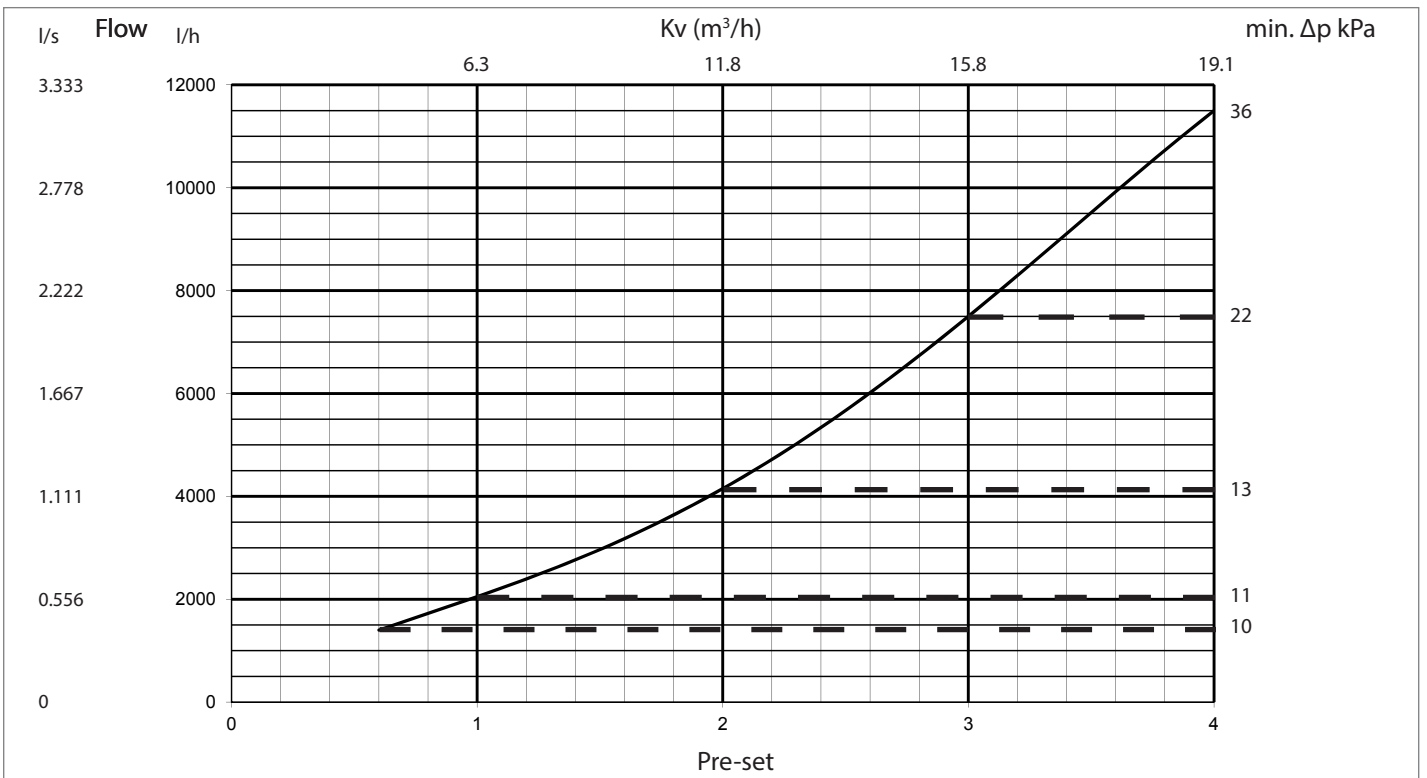

Frese OPTIMA Compact DN10-DN50 Pressure Independent Balancing & Control Valve

Setting and Flow

OPTIMA Compact Low 2,5 DN10/15				OPTIMA Compact Low 5,0 DN10/15			OPTIMA Compact High 2,5 DN15/20		
Pre-set	Flow l/h	Flow l/s	Flow gpm	Flow l/h	Flow l/s	Flow gpm	Flow l/h	Flow l/s	Flow gpm
0.5	30	0.008	0.13						
0.6	35	0.010	0.15	65	0.018	0.29	100	0.028	0.44
0.8	45	0.012	0.20	83	0.023	0.37	128	0.036	0.56
1.0	54	0.015	0.24	101	0.028	0.44	156	0.043	0.69
1.2	64	0.018	0.28	119	0.033	0.52	184	0.051	0.81
1.4	74	0.020	0.32	137	0.038	0.60	212	0.059	0.93
1.6	83	0.023	0.37	155	0.043	0.68	240	0.067	1.06
1.8	93	0.026	0.41	173	0.048	0.76	268	0.074	1.18
2.0	103	0.029	0.45	191	0.053	0.84	296	0.082	1.30
2.2	113	0.031	0.50	209	0.058	0.92	324	0.090	1.42
2.4	122	0.034	0.54	226	0.063	1.00	351	0.098	1.55
2.6	132	0.037	0.58	244	0.068	1.08	379	0.105	1.67
2.8	142	0.039	0.62	262	0.073	1.15	407	0.113	1.79
3.0	151	0.042	0.67	280	0.078	1.23	435	0.121	1.92
3.2	161	0.045	0.71	298	0.083	1.31	463	0.129	2.04
3.4	171	0.047	0.75	316	0.088	1.39	491	0.136	2.16
3.6	181	0.050	0.79	334	0.093	1.47	519	0.144	2.29
3.8	190	0.053	0.84	352	0.098	1.55	547	0.152	2.41
4.0	200	0.056	0.88	370	0.103	1.63	575	0.160	2.53

OPTIMA Compact High 5,0 DN15/20				OPTIMA Compact High 5,5 DN20			OPTIMA Compact Low 5,5 DN25		
Pre-set	Flow l/h	Flow l/s	Flow gpm	Flow l/h	Flow l/s	Flow gpm	Flow l/h	Flow l/s	Flow gpm
0.6	220	0.061	0.97	300	0.083	1.32	280	0.078	1.23
0.8	285	0.079	1.26	395	0.110	1.74	356	0.099	1.57
1.0	351	0.097	1.54	480	0.133	2.11	430	0.119	1.89
1.2	416	0.116	1.83	558	0.155	2.46	502	0.139	2.21
1.4	481	0.134	2.12	632	0.176	2.78	574	0.159	2.53
1.6	546	0.152	2.41	704	0.196	3.10	647	0.180	2.85
1.8	612	0.170	2.69	776	0.216	3.42	722	0.201	3.18
2.0	677	0.188	2.98	850	0.236	3.74	800	0.222	3.52
2.2	742	0.206	3.27	927	0.258	4.08	881	0.245	3.88
2.4	808	0.224	3.56	1008	0.280	4.44	967	0.269	4.26
2.6	873	0.242	3.84	1094	0.304	4.82	1057	0.294	4.65
2.8	938	0.261	4.13	1185	0.329	5.22	1151	0.320	5.07
3.0	1004	0.279	4.42	1280	0.356	5.64	1250	0.347	5.50
3.2	1069	0.297	4.71	1380	0.383	6.07	1353	0.376	5.96
3.4	1134	0.315	4.99	1483	0.412	6.53	1460	0.406	6.43
3.6	1199	0.333	5.28	1589	0.441	6.99	1571	0.436	6.92
3.8	1265	0.351	5.57	1695	0.471	7.46	1685	0.468	7.42
4.0	1330	0.369	5.85	1800	0.500	7.93	1800	0.500	7.93

OPTIMA Compact High 5,5 DN25L				OPTIMA Compact DN32		
Pre-set	Flow l/h	Flow l/s	Flow gpm	Flow l/h	Flow l/s	Flow gpm
0.6	600	0.167	2.64	550	0.153	2.42
0.8	777	0.216	3.42	753	0.209	3.32
1.0	954	0.265	4.20	956	0.266	4.21
1.2	1131	0.314	4.98	1159	0.322	5.10
1.4	1308	0.363	5.76	1362	0.378	6.00
1.6	1485	0.413	6.54	1565	0.435	6.89
1.8	1662	0.462	7.32	1768	0.491	7.79
2.0	1839	0.511	8.10	1971	0.548	8.68
2.2	2016	0.560	8.88	2174	0.604	9.57
2.4	2193	0.609	9.66	2377	0.660	10.47
2.6	2370	0.658	10.44	2580	0.717	11.36
2.8	2547	0.708	11.22	2783	0.773	12.26
3.0	2724	0.757	12.00	2986	0.829	13.15
3.2	2901	0.806	12.78	3189	0.886	14.04
3.4	3078	0.855	13.55	3392	0.942	14.94
3.6	3255	0.904	14.33	3595	0.999	15.83
3.8	3432	0.953	15.11	3798	1.055	16.73
4.0	3609	1.003	15.89	4001	1.111	17.62

Frese OPTIMA Compact DN10-DN50 Pressure Independent Balancing & Control Valve

Setting and Flow

Pre-set	OPTIMA Compact DN40			OPTIMA Compact DN50		
	Flow l/h	Flow l/s	Flow gpm	Flow l/h	Flow l/s	Flow gpm
0.6	1370	0.381	6.03	1400	0.389	6.16
0.8	1681	0.467	7.40	1724	0.479	7.59
1.0	2000	0.556	8.81	2050	0.569	9.03
1.2	2333	0.648	10.27	2393	0.665	10.54
1.4	2686	0.746	11.83	2766	0.768	12.18
1.6	3063	0.851	13.48	3178	0.883	13.99
1.8	3467	0.963	15.26	3638	1.011	16.02
2.0	3900	1.083	17.17	4150	1.153	18.27
2.2	4364	1.212	19.21	4717	1.310	20.77
2.4	4857	1.349	21.39	5339	1.483	23.51
2.6	5380	1.494	23.69	6014	1.671	26.48
2.8	5928	1.647	26.10	6737	1.871	29.66
3.0	6500	1.806	28.62	7500	2.083	33.02
3.2	7090	1.969	31.22	8295	2.304	36.52
3.4	7692	2.137	33.87	9108	2.530	40.10
3.6	8300	2.306	36.54	9925	2.757	43.70
3.8	8906	2.474	39.21	10729	2.980	47.24
4.0	9500	2.639	41.83	11500	3.194	50.63

