

LCF Touch

Electronic FanCoil Thermostat with Touch Display (flush mounting)
(ab Firmware 2.4)

thermokon[®]
HOME OF SENSOR TECHNOLOGY

Datasheet

Subject to technical alteration
Issue date: 2/9/2022 • A121



» APPLICATION

Modern design flush mounting fan coil room thermostat, used for individual control of temperature in commercial, industrial and residential buildings. It is tailored for two-pipe and four-pipe fan coil units with two-wire electric valves. The device combines digital technology with a large LCD touch screen display, which enables the 2-point- single room controller to be used intuitively. Integrated 7 day time clock with 4 time programs.

» SECURITY ADVICE – CAUTION

The installation and assembly of electrical equipment should only be performed by authorized personnel.



The product should only be used for the intended application. Unauthorised modifications are prohibited! The product must not be used in relation with any equipment that in case of a failure may threaten, directly or indirectly, human health or life or result in danger to human beings, animals or assets. Ensure all power is disconnected before installing. Do not connect to live/operating equipment.

CAUTION! Risk of electric shock due to live components within the enclosure, especially devices with mains voltage supply (usually between 90..265 V).



Please comply with

- Local laws, health & safety regulations, technical standards and regulations
- Condition of the device at the time of installation, to ensure safe installation
- This data sheet and installation manual

» NOTES ON DISPOSAL



As a component of a large-scale fixed installation, Thermokon products are intended to be used permanently as part of a building or a structure at a pre-defined and dedicated location, hence the Waste Electrical and Electronic Act (WEEE) is not applicable. However, most of the products may contain valuable materials that should be recycled and not disposed of as domestic waste. Please note the relevant regulations for local disposal.

» GENERAL REMARKS CONCERNING SENSORS

Especially with regard to passive sensors in 2-wire conductor versions, the wire resistance of the supply wire has to be considered. If necessary the wire resistance has to be compensated by the follow-up electronics. Due to self-heating, the wire current affects the measurement accuracy, so it should not exceed 1 mA.

When using lengthy connection wires (depending on the cross section used) the measuring result might be falsified due to a voltage drop at the common GND-wire (caused by the voltage current and the line resistance). In this case, 2 GND-wires must be wired to the sensor - one for supply voltage and one for the measuring current.

Sensing devices with a transducer should always be operated in the middle of the measuring range to avoid deviations at the measuring end points. The ambient temperature of the transducer electronics should be kept constant. The transducers must be operated at a constant supply voltage ($\pm 0,2$ V). When switching the supply voltage on/off, onsite power surges must be avoided.

» MOUNTING ADVISE ROOM SENSORS

The Accuracy of the room sensors are influenced by the technical specifications as well as the positioning and the installation type.

During Assembly:

- Seal mounting box (if present).
- Installation type, air draught, heat source, radiation heat or direct sunlight can affect the measurement.
- Bulding material specific properties of the installation place (*brick-, concrete-, partition wall, cavity wall, ...*) can affect the measurement. (e.g.: *Concrete accepts room temperature variation slower than cavity walls*)

Assembly not recommendet in...

- Air draught (e.g.: close to windows / doors / fans ...)
- Near heating sources,
- Direct sunlight
- Niches / between furniture / ...

» TECHNICAL DATA

Measuring values	temperature	
Output switch contact	Terminal 1 2 3 3 normally open contacts FanCoil 240 V max. load 3 A fan stages switchover pause 0,5 s	Terminal 4 5 (2-point-controller) 2 normally open contacts heating/cooling 240 V max. load 3 A
Power supply	90..265 V ~	
Power consumption	0,9 VA (265 V ~)	
Measuring range temp	+34..+99 °F	
Accuracy temperature	$\pm 0,5$ K (typ. at 70 °F)	
Sensor	NTC10k	
Inputs	Terminal 7 8 input for change-over sensor (NTC 10 K)	
Control functions	setpoint adjustment +34..+99 °F, (Default +60..+86 °F)	
Display	LCD-module with Touch and LED-illumination	
Enclosure	ABS, scratch-resistant acrylic glass	
Protection	IP20 according to EN 60529	
Connection electrical	terminal block max. 16AWG	
Ambient condition	+14..+122 °F, max. 85% rH non-condensing	
Weight	5.64 oz.	
Mounting	flush mounted with standard EU box ($\varnothing=2.36$ in.)	

» PRODUCT TESTING AND CERTIFICATION



Declaration of conformity

The declaration of conformity of the products can be found on our website <https://www.thermokon.de/>

» CONNECTION PLAN

LCF Touch Modbus – Auto mode wiring diagram for 2-pipe fan coil

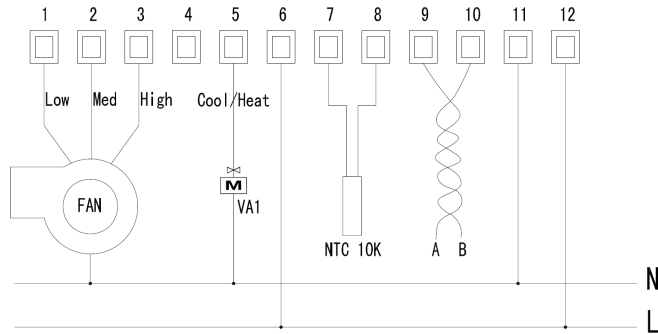

LCF Touch Modbus – Manual mode wiring diagram for 2-pipe fan coil

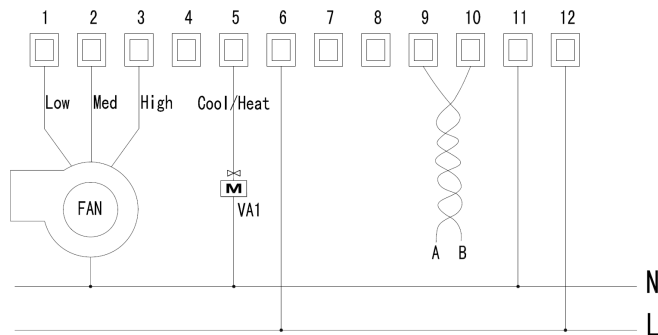

LCF Touch Modbus – wiring diagram for 4-pipe fan coil

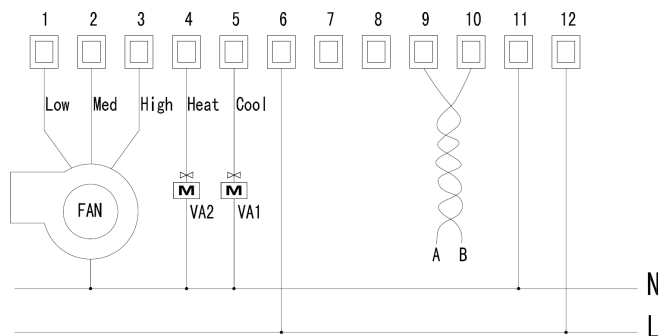

» MOUNTING ADVICES

For installing or repairing, please make sure the power for the thermostat has been turned off.

1. Insert the screw driver in the plastic teeth of the thermostat to open the enclosure.
2. Please follow the wiring diagram to connect the wires.
3. Fix the thermostat base plate to the wall by using the four screw holes with a distance between the axes of 2.36 in.
4. Fasten base plate and front cover. Do not press the panel in order to protect LCD.

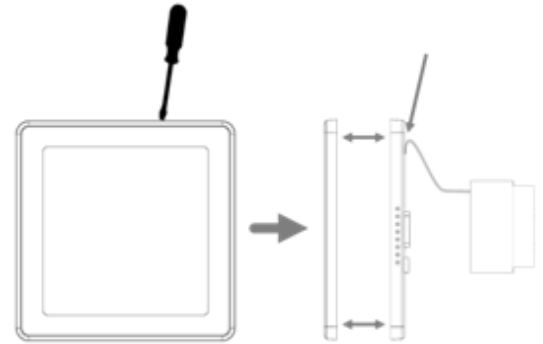

» COMMISSIONING

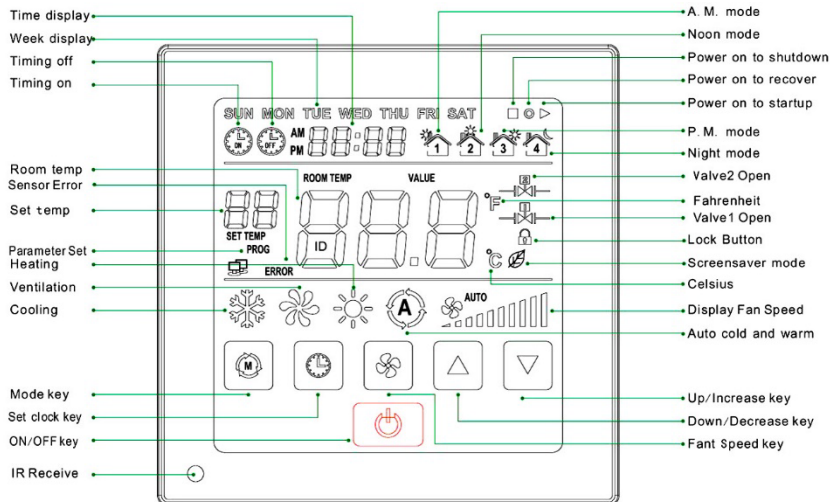

Setting parameter No. 13, the selection of the fan coil system has to be done. 2-pipe or 4-pipe systems can be selected.

Hysteresis: 1 K + 1 minute switching delay

Operation in 2-pipe system (parameter No. 13 set to 2):

When using a change-over sensor, the thermostat can detect whether the fluid is convenient for cooling or for heating:

- Operation without a change-over sensor:
In the 2-pipe system, a fluid can be used only for cooling or only for heating depending on the temperature of the fluid. When no change-over sensor is used, heating, cooling and ventilating mode have to be selected manually using MODE settings (depending on the desired action of the heating/cooling system).
- Operation with a change-over sensor:
By using an change-over sensor, the system recognizes, whether the fluid has the necessary temperature for cooling or for heating. The heating or cooling control sequence will be automatically selected. When temperature is $\leq +66$ °F, cooling mode is activated; when the temperature is $\geq +86$ °C, the heating mode is active.
MODE key has no function in this case.

Operation in 4-pipe system (parameter No. 13 set to 4):

The thermostat switches automatically between cooling and heating. A time delay between cooling/heating mode changes is implemented to ensure safe and eco-friendly operation. Parameter No.14 has to be set to 1 to enable the device for operating in auto mode.

Mode selection:

Manual Mode: 2-pipe-System: Cooling → Ventilating → Heating
4-pipe-System: Cooling → Ventilating → Heating → Auto mode (only when parameter No. 14 is set to 1!)

AUTO-Mode: The mode will be selected automatically.

Fan Stage selection:

In Cooling, Heating or Auto mode, following fan stages can be selected:

Low → Med → Hi → Auto

In Ventilation mode, following fan stages can be selected:

Low → Med → Hi

Ventilation mode can be deactivated by setting parameter No. 15.

Auto mode:

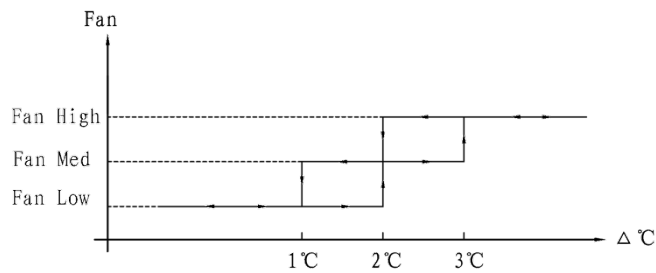

Display °C or °F

Display of the units °C or °F can be selected using parameter No. 12. Fahrenheit temperature display range is 34..99 °F, °C temperature display range is 0..50 °C. Factory default is °C.

Note: Under Parameter No.1 the temperature offset can be adjusted. This feature should be used if the temperature at the mounting place of the Room Thermostat is not accurate to the average room temperature.

Temperature Room Temperature set point selection:

By pressing “▲” or “▼” button, the room temperature set point can be adjusted. °C Range is 16..30 °C, Fahrenheit temperature range is 60..86 °F.

By using Parameter No. 4 and No. 5, the set point ranges can be adjusted.

Fan stage/Valve control selection:

Under Fan operation “INDEPENDENT”, the fan will always operate according to the selected or automatically assigned fan stage; under Fan operation “DEPENDENT”, the fan will be tuned off in case the valve is closed. If the valve is open, the fan will operate according to the selected or automatically assigned fan stage.

By using parameter No. 16, the “INDEPENDENT” or “DEPENDENT” mode can be selected.

Key lock selection (No. 2), power failure selection (No. 3), screen save mode (No. 6) can be set by Parameters.

Also in parameter No. 7 you are able to read the LCD display status.

Sensor failure alarm:

If the temperature sensor is out of range, the thermostat will switch off the fan and close the valve, error code “E01” will be shown.

Language selection

You can change the display language with parameter No. 11.

Set time format

With parameter No. 8 the time format can be defined (12h or 24).

Time setting



Press the “ ” button, to set the time. The changing parameter is flashing, press “▲” or “▼”-button to set:

Order: Weekday→hour→minute→Timer on→Timer off→weekday→hour→...

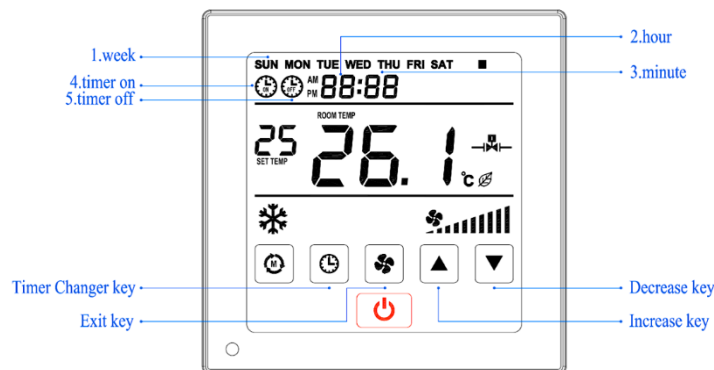

Set timer

Press the “🕒”-button, the parameter to be changed is flashing, the timer will be set on or off.

Finish: Timer on, LCD display  ;

Finish: Timer off, LCD display  ;

To delete timer on/off, press the “🕒” button, the parameter to be changed is flashing. Then select “🕒 ON” or “🕒 OFF”, set the time like the following image to leave the timer mode: “AM - - : - - ”.

The system saves the user settings to set the timer on / off automatically.

Selection timer on / off

The timer on/off has 2 options to be selected: single action or rule.

To set, please look up parameter No. 9 in the parameter table.

7 days 4 periods programmable timer

One day is split into 4 periods. The user can set temperature for every period individually.

To set the time zones, please look up parameter No. 10 in the parameter table.

If the user has set a set temperature during operation, the current period runs with the last set temperature. The next period will adopt the changed settings.

Please follow the instructions below:

Press the “🕒” button for more than 5 seconds, the parameter to be changed is flashing. Now you can set the 4 programmable periods.

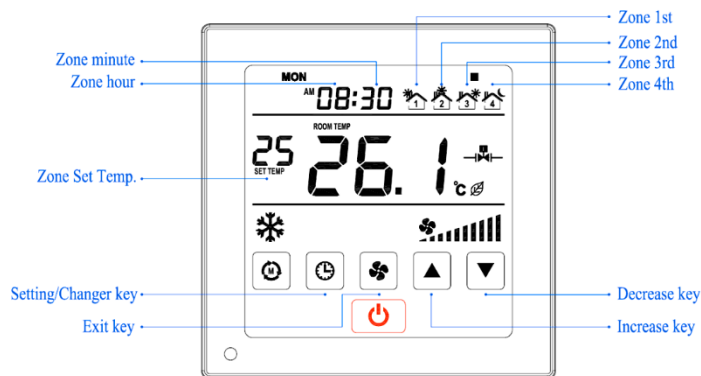
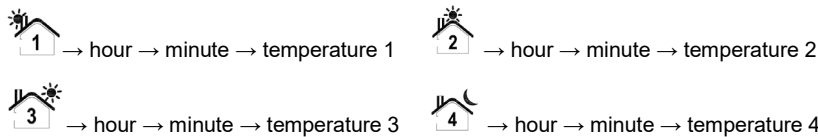

Configuration

Parameters

 = MODE button

In order to change the parameters, please press the MODE button for more than 5 seconds. Please follow figure below. If you are asked to enter the password, use “▲” or “▼” key to enter each digit of the password. Press MODE button to switch to the next digit.

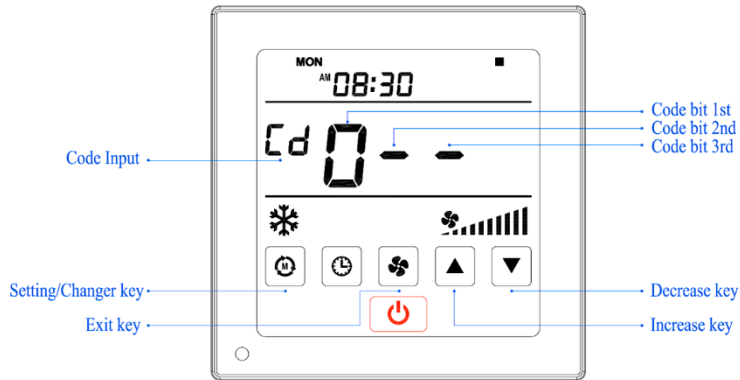

The factory default password is 260

If the password has been entered correctly, you will see the parameter settings screen as below shown.

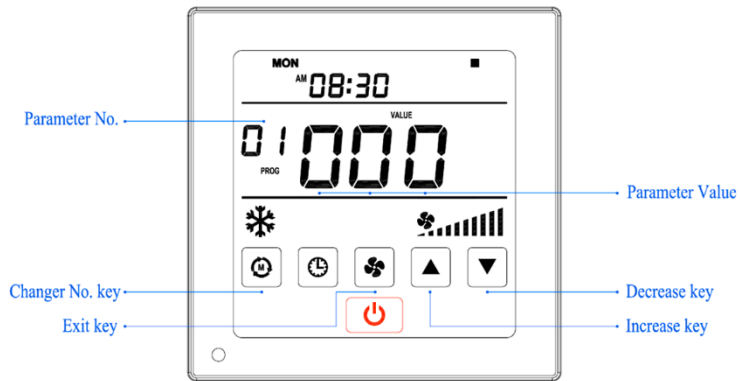

After parameter selection / setting, don't press any button for 3 seconds to save the settings.

Press the MODE button to select the parameter you would like to change. Then use “▲” or “▼” to change the parameter. Please refer to the parameter table on the following page: All parameters are stored within an EEPROM (electrically erasable programmable ROM), ensuring no data loss if the Thermostat is powered off.

No.	Name of parameter	Parameter definition	Factory default
01	Temperature offset:	Range -20..+20 K	0
02	Key-lock:	00 = no lock 01 = on/off locked 02 = lock "mode" 03 = lock "on/off" and "mode" 04 = lock " clock " 05 = lock on/off and clock 06 = lock mode & clock 07 = lock on/off & mode & clock 08 = lock fan 09 = lock fan & on/off 10 = lock fan & mode 11 = lock fan & on/off & mode 12 = lock fan & clock 13 = lock fan & clock & on/off 14 = lock fan & clock & mode 15 = lock fan & clock & on/off & mode 16 = lock Temp 17 = lock Temp & on/off 18 = lock temp & Mode 19 = lock temp & on/off & mode 20 = lock Temp & clock 21 = lock temp & clock & on/off 22 = lock temp & clock & mode 23 = lock temp & clock & mode & on/off 24 = lock Temp & fan 25 = lock Temp & fan & on/off 26 = lock temp & fan & Mode 27 = lock temp & fan & on/off & mode 28 = lock Temp & fan & clock 29 = lock temp & fan & clock & on/off 30 = lock temp & fan & clock & mode 31 = lock temp & fan & clock & mode & on/off = lock all keys	0
03	Power failure:	0- stay power off 1- restore last status before power failure 2- turn power on after power failure	1
04	Upper temperature limit:	Range: +1..+50 °C / +34..99 °F	30 °C / 86 °F
05	Lower temperature limit:	Range: +1..+50 °C / +34..99 °F	16 °C / 60 °F
06	LCD backlight delay:	10..150 seconds	20 seconds
07	Screensaver mode:	0- display off 1- room temperature 2- display clock, room temperature 3- display on	1
08	Time format:	12- 12 hours 24- 24 hours	12
09	Timer on / off:	0- one-timer (1 day) 1- recurring timer	0
10	7 days, 4 periods programmable:	0- deactivated 1- activated	0
11	Display language:	1- English	1
12	Temperature format:	0- °C 1- °F	0
13	Selection Fan Coil:	2- 2-pipe Fan Coil, heating/cooling 4- 4-pipe Fan Coil, heating/cooling 6- 2-pipe Fan Coil cooling+electric-heater	2
14	Auto cooling & heating modus:	0- deactivated 1- activated	0
15	Fan modus:	0- deactivated 1- activated	1
16	Fan on/off selective	0-valve stop does chain fan, 1-Valve stop chain fan	0
17	Temporarily not defined		0
18	Communication:	ID.1.. ID.247	1
19	Baud rate:	1- 4800 bps; 2- 9600 bps; 3- 19200 bps; 4- 38400 bps	2
20	Parity	0-no parity 1-odd parity 2-even parity	0
21	Summer/winter time	0- deactivated 1- auto	1
22	Individual password setting	001-999	260
23	Stopbit	1=1bit, 2=2bit	2
24	Infrared receiver (remote)	0 – deactivated, 1 - activated	0
25	Backlight in case of inactivity	0-25% (0=OFF)	15

» DIMENSIONS (IN.)

Display unit:

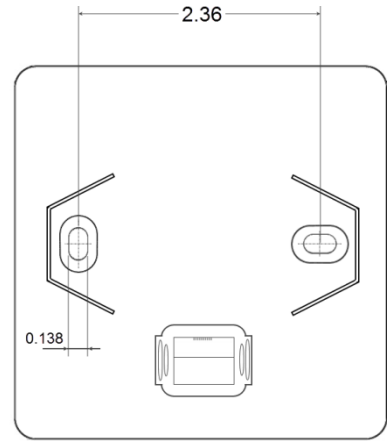
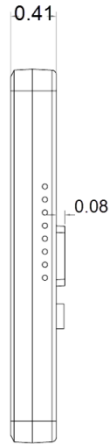
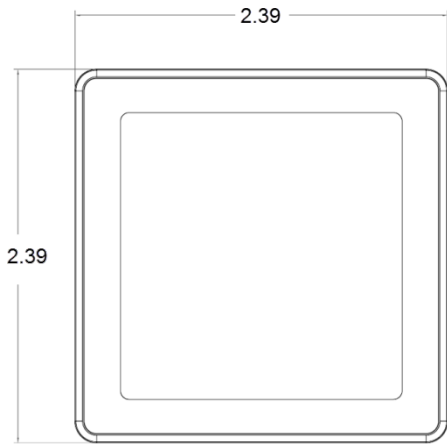

Base plate:

