

# RPF100 | RPF100+

Room pendulum temperature sensor

**thermokon**<sup>®</sup>  
HOME OF SENSOR TECHNOLOGY

## Datasheet

Subject to technical alteration  
Issue date: 12/23/2022 • A120



### » APPLICATION

Pendulum sensor for temperature measurement in large, high rooms and spaces like open space offices, galleries, production plants and similar for control and monitoring applications.

### » TYPES AVAILABLE

#### Room pendulum sensor temperature – passive | without connection housing

- RPF100 <sensor> L1000

#### Room pendulum sensor temperature – passive

- RPF100+ <sensor> L1000

#### Room pendulum sensor temperature – active TRV 0..10 V | TRA 4..20 mA

- RPF100+ TRV MultiRange L1000
- RPF100+ TRA MultiRange L1000

MultiRange: Measuring ranges adjustable at the transducer

<sensor>: PT100/PT1000/NI1000/NI1000TK5000/LM235Z/NTC.../PTC... other sensors on request

### » SECURITY ADVICE – CAUTION

The installation and assembly of electrical equipment should only be performed by authorized personnel.



The product should only be used for the intended application. Unauthorised modifications are prohibited! The product must not be used in relation with any equipment that in case of a failure may threaten, directly or indirectly, human health or life or result in danger to human beings, animals or assets. Ensure all power is disconnected before installing. Do not connect to live/operating equipment.

Please comply with

- Local laws, health & safety regulations, technical standards and regulations
- Condition of the device at the time of installation, to ensure safe installation
- This data sheet and installation manual

### » PRODUCT TESTING AND CERTIFICATION



#### Declaration of conformity

The declaration of conformity of the products can be found on our website <https://www.thermokon.de/>.

## » NOTES ON DISPOSAL



As a component of a large-scale fixed installation, Thermokon products are intended to be used permanently as part of a building or a structure at a pre-defined and dedicated location, hence the Waste Electrical and Electronic Act (WEEE) is not applicable. However, most of the products may contain valuable materials that should be recycled and not disposed of as domestic waste. Please note the relevant regulations for local disposal.

---

## » GENERAL REMARKS CONCERNING SENSORS

Especially with regard to passive sensors in 2-wire conductor versions, the wire resistance of the supply wire has to be considered. If necessary the wire resistance has to be compensated by the follow-up electronics. Due to self-heating, the wire current affects the measurement accuracy, so it should not exceed 1 mA.

When using lengthy connection wires (depending on the cross section used) the measuring result might be falsified due to a voltage drop at the common GND-wire (caused by the voltage current and the line resistance). In this case, 2 GND-wires must be wired to the sensor - one for supply voltage and one for the measuring current.

Sensing devices with a transducer should always be operated in the middle of the measuring range to avoid deviations at the measuring end points. The ambient temperature of the transducer electronics should be kept constant. The transducers must be operated at a constant supply voltage ( $\pm 0,2$  V). When switching the supply voltage on/off, onsite power surges must be avoided.

---

## » BUILD-UP OF SELF-HEATING BY ELECTRICAL DISSIPATIVE POWER

Sensors with electronic components always have a dissipative power, which affects the temperature measurement of the ambient air. The dissipation in active temperature sensors shows a linear increase with rising operating voltage. This dissipative power has to be considered when measuring temperature. In case of a fixed operating voltage ( $\pm 0,2$  V) this is normally done by adding or reducing a constant offset value.

Thermokon transducers can be operated with variable operating voltages. The transducers are set at the factory with a reference operating voltage of 24 V =.

At this voltage, the expected measuring error of the output signal will be the least. Other operating voltages, can cause a measurement deviation changing power loss of the sensor electronics.

A recalibration can be carried out directly on the unit or via a software variable (app or bus).

**Remark: Occurring draught leads to a better carrying-off of dissipative power at the sensor. Thus temporally limited fluctuations might occur upon temperature measurement.**

---

## » USE ENCLOSURE WITH UV AND WEATHER RESISTANCE

After some time, outdoor mounted plastics can lose their color and quality. Therefore, all USE housings are made of special white polycarbonate (PC). The light-stable colorants and additives are used to achieve optimum protection of the polymer while maintaining color stability. The titanium dioxide used is specially developed for polycarbonate and offers excellent UV protection through the reflection of the entire light spectrum including the UV component by 340 nm. This effectively counteracts the otherwise occurring photochemical polymer degradation. The colors stay full for a long time without fading. The material is also resistant to cold and frost.

» **TECHNICAL DATA**

|  |   |   |  |                                      |
|--|---|---|--|--------------------------------------|
| Measuring values   | temperature   |   |  |                                      |
| Output voltage   | <b>TRV</b><br>1x 0..10 V or 0..5 V, min. load 5 kΩ  |   |  |                                      |
| Output ampere  | <b>TRA</b><br>1x 4..20 mA, max. load 500 Ω  |   |  |                                      |
| Output passive   | <b>passive</b><br>optional, PT100/PT1000/Ni1000/Ni1000TK5000/LM235Z/NTC.../PTC... other sensors on request  |   |  |                                      |
| Power supply   | <b>TRV</b><br>15..24 V = (±10%) or 24 V ~ (±10%) SELV   |   | <b>TRA</b><br>15..24 V = (±10%) SELV                                       |                                      |
| Power consumption  | <b>TRV</b><br>typ. 0,4 W (24 V =)   0,8 VA (24 V ~)   |   | <b>TRA</b><br>typ. 0,5 W (24 V =)  |                                      |
| Measuring range temp.  | <b>passive</b><br>-31..+194 °F  |   |  |                                      |
| Output signal range temperature<br><i>*Scaling analogue output</i>             | <b>TRV   TRA</b><br>0..+150 °F (default setting), selectable from 8 temperature ranges<br>-30..+130   0..+250   +40..+140   0..+150   +30..+480   0..+100   +40..+240   +40..+90 °F<br>adjustable at the transducer |   |  |                                      |
| Operating temperature range<br><i>* Max. permissible operating temperature</i> | <b>sensor pocket</b><br>-31..+194 °F  | <b>electronic – TRV TRA</b><br>-31..+158 °F | <b>electronic – passive</b><br>-31..+194 °F                                | <b>mounting base</b><br>-31..+194 °F |
| Operating temperature range  | max permissible operating temperature -31..+158 °F  |   |  |                                      |
| Accuracy temperature   | <b>TRV   TRA</b><br>±0,5 K (typ. at 70 °F within default measuring range)   |   | <b>passive</b><br>typ. ±0,3 K (typ. at 70 °F),<br>depending on used sensor |                                      |
| Sensor   | <b>passive</b><br>2-wire (default), 3-wire or 4-wire  |   |  |                                      |
| Enclosure<br><i>(type-dependent)</i>   | enclosure USE-S, PC, pure white, with removable cable entry   |   |  |                                      |
| Protection   | IP65 according to EN 60529  |   |  |                                      |
| Cable entry  | Flextherm M20, for wire max. Ø=0.18..0.35 in., removable  |   |  |                                      |
| Connection electrical  | removable plug-in terminal, max. AWG14, sensor wire PVC soft, white, 3.3 ft. (default), 3.3 ft. m, 13.1 ft., 19.7 ft., for other lengths please request   |   |  |                                      |
| Pocket   | stainless steel V2A, Ø=0.6 in., mounting length 4 in., hex pressed  |   |  |                                      |
| Ambient condition  | max. 85% rH short term condensation   |   |  |                                      |
| Notes  | other cable lengths on request  |   |  |                                      |

» **CONNECTION PLAN AND CONFIGURATION**

The adjustment of the measuring ranges is made by changing the jumpers in a de-energized state. The output value of the new measuring range is available after 2 seconds. *fig. TRA/TRV (Measuring range and offset adjustment, default settings: 0 °F..+150 °F | 0 F)*

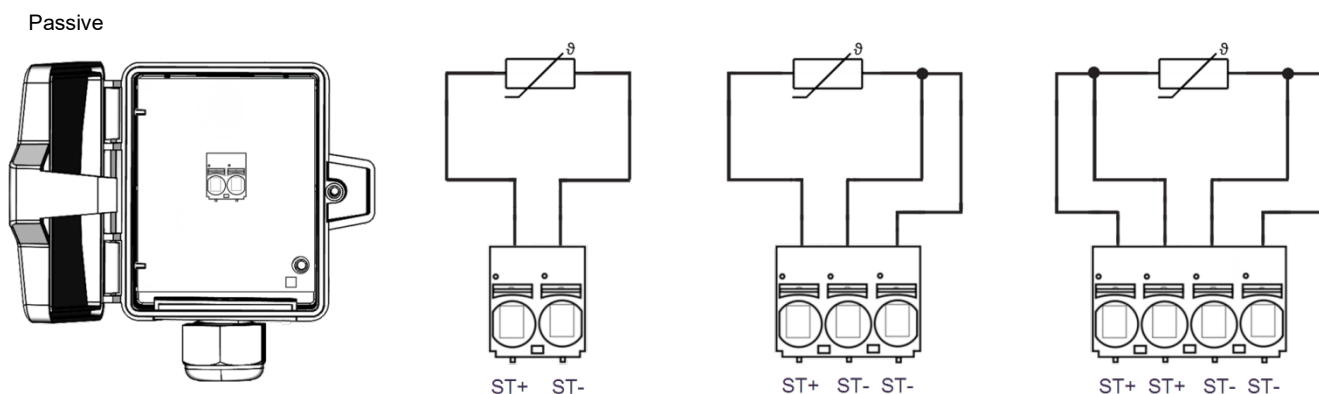

TRA:  
4..20 mA

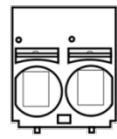
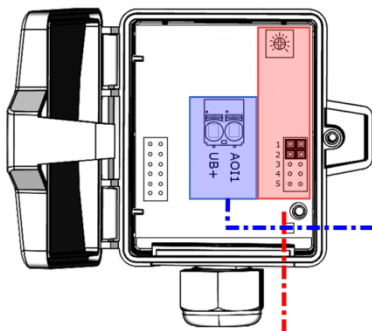

UB+ AOI1

TRV:  
0..10 V | 0..5 V

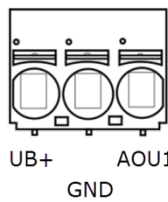
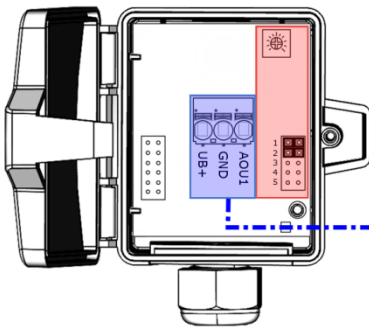

UB+ AOI1  
GND

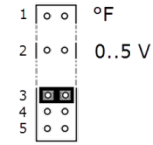
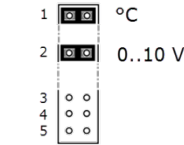
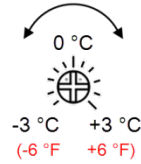

-50 °C..+50 °C  
(-30 °F..+130 °F)

-10 °C..+120 °C  
(0 °F..+250 °F)

0 °C..+50 °C  
(+40 °F..+140 °F)

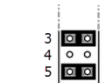

0 °C..+100 °C  
(+40 °F..+240 °F)

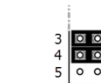

0 °C..+250 °C  
(+30 °F..+480 °F)

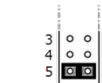

-15 °C..+35 °C  
(0 °F..+100 °F)



0 °C..+160 °C  
(0 °F..+150 °F)



-20 °C..+80 °C  
(+40 °F..+90 °F)

» DIMENSIONS (IN.)

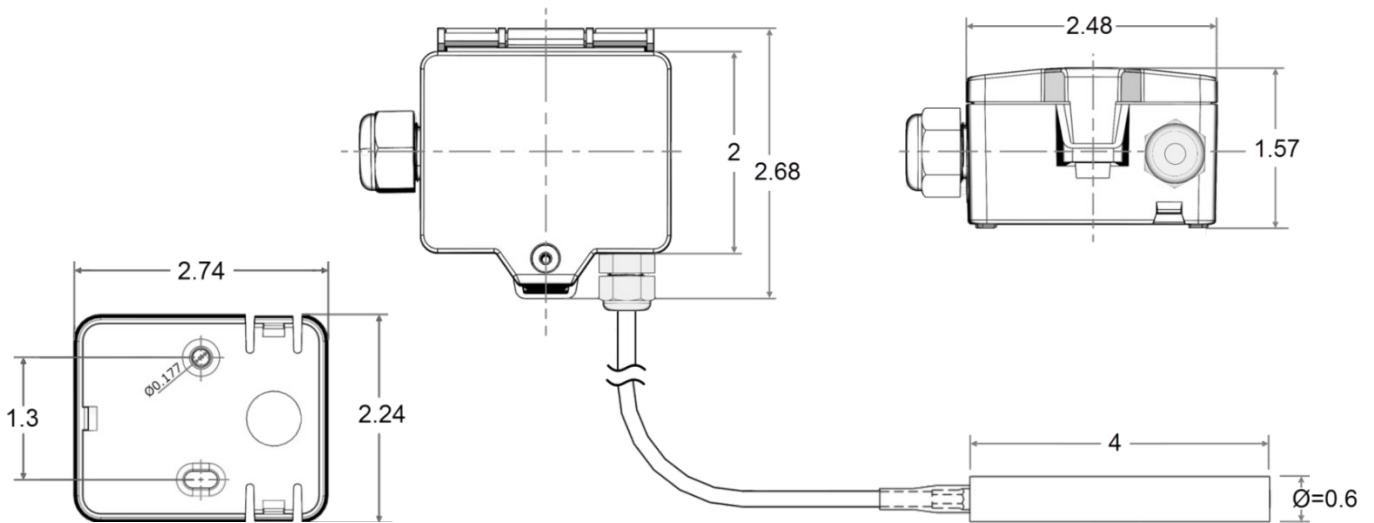

» ACCESSORIES (INCLUDED IN DELIVERY)

Mounting base enclosure USE pure white  
Mounting kit universal  
• Cover screw + screw cover • 2 Rawlplugs • 2 Screws (countersunk head) • 2 Screws (rounded head)

Item No. 667722  
Item No. 698511

» ACCESSORIES (OPTIONAL)

Mounting clip enclosure USE pure white  
Sealing insert M20 USE white, 2x Ø=0.28 in. (for 2 wire; PU 10 pieces)

Item No. 616423  
Item No. 641333