

LCF02 Touch 2AO3DO

Fancoil-controller

thermokon[®]
HOME OF SENSOR TECHNOLOGY

Datasheet

Subject to technical alteration
Issue date: 19.04.2023 • A127



» APPLICATION

The fancoil room controller has been designed for individual control of temperature in commercial, industrial and residential buildings. It is tailored for two-pipe fan coil with two-wire electric valves and has 2 analogue outputs 0..10 V (heating and cooling) and 3 relay outputs for controlling a 3-stage fan. A 6-way valve can also be used. With its flush mounted modern design the device combines digital technology with a large LCD display and additional buttons, which enables the single room controller to be used intuitively.

» SECURITY ADVICE – CAUTION

The installation and assembly of electrical equipment should only be performed by authorized personnel.



The product should only be used for the intended application. Unauthorised modifications are prohibited! The product must not be used in relation with any equipment that in case of a failure may threaten, directly or indirectly, human health or life or result in danger to human beings, animals or assets. Ensure all power is disconnected before installing. Do not connect to live/operating equipment.

CAUTION! Risk of electric shock due to live components within the enclosure, especially devices with mains voltage supply (usually between 90..265 V).



Please comply with

- Local laws, health & safety regulations, technical standards and regulations
- Condition of the device at the time of installation, to ensure safe installation
- This data sheet and installation manual

» NOTES ON DISPOSAL



As a component of a large-scale fixed installation, Thermokon products are intended to be used permanently as part of a building or a structure at a pre-defined and dedicated location, hence the Waste Electrical and Electronic Act (WEEE) is not applicable. However, most of the products may contain valuable materials that should be recycled and not disposed of as domestic waste. Please note the relevant regulations for local disposal.

» MOUNTING ADVISE ROOM SENSORS

The Accuracy of the room sensors are influenced by the technical specifications as well as the positioning and the installation type.

During Assembly:

- Seal mounting box (if present).
- Installation type, air draught, heat source, radiation heat or direct sunlight can affect the measurement.
- Bulding material specific properties of the installation place (*brick-, concrete-, partition wall, cavity wall, ...*) can affect the measurement.
(e.g.: *Concrete accepts room temperature variation slower than cavity walls*)

Assembly not recommendet in...

- Air draught (e.g.: close to windows / doors / fans ...)
- Near heating sources,
- Direct sunlight
- Niches / between furniture / ...

» TECHNICAL DATA

Measuring values	temperature		
Output voltage	terminal 2 3 (for heating and cooling) 2x 0..10 V, min. load 10 kΩ		
Output switch contact	terminal 5 6 7 – LO ME HI (for Fan) 3x normally open contact, max. 250 V ~ / 3 A max. 30 V = / 3 A		
Network technology	RS485 Modbus, RTU, half-duplex, baud rate 4.800, 9.600, 19.200 or 38.400, parity: non (2 stopbits), even or odd (1 stopbit), RS485 bus load: ¼ unit load according to RS485 standard (max. 128 devices)		
Power supply	24 V = (±10%) 24 V ~ (±20%) SELV		
Power consumption	3 W (24 V =)		
Measuring range temp.	+1..+50 °C		
Accuracy temperature	±1 K (typ. at 21 °C)		
Inputs	terminal 10 input for external sensor NTC10K	terminal 11 – ESI DP input digital for floating contact, window contact, dew point sensor	terminal 12 - OCC input digital for floating contact, occupancy sensor, key card switch
Control functions	set point adjustment +1..+50 °C, (default +16..+30 °C)		
Display	LCD 64x64 mm, white oder black background lighting		
Enclosure	ABS, pure white or black		
Protection	IP20 according to EN 60529		
Cable entry	rear entry		
Connection electrical	terminal block max. 1,5 mm ²		
Ambient condition	-10..+50 °C, max. 95% rH non-condensing		
Mounting	flush mounted with standard EU box (Ø=60 mm)		

» PRODUCT TESTING AND CERTIFICATION



Declaration of conformity

The declaration of conformity of the products can be found on our website <https://www.thermokon.de/>

» CONNECTION PLAN

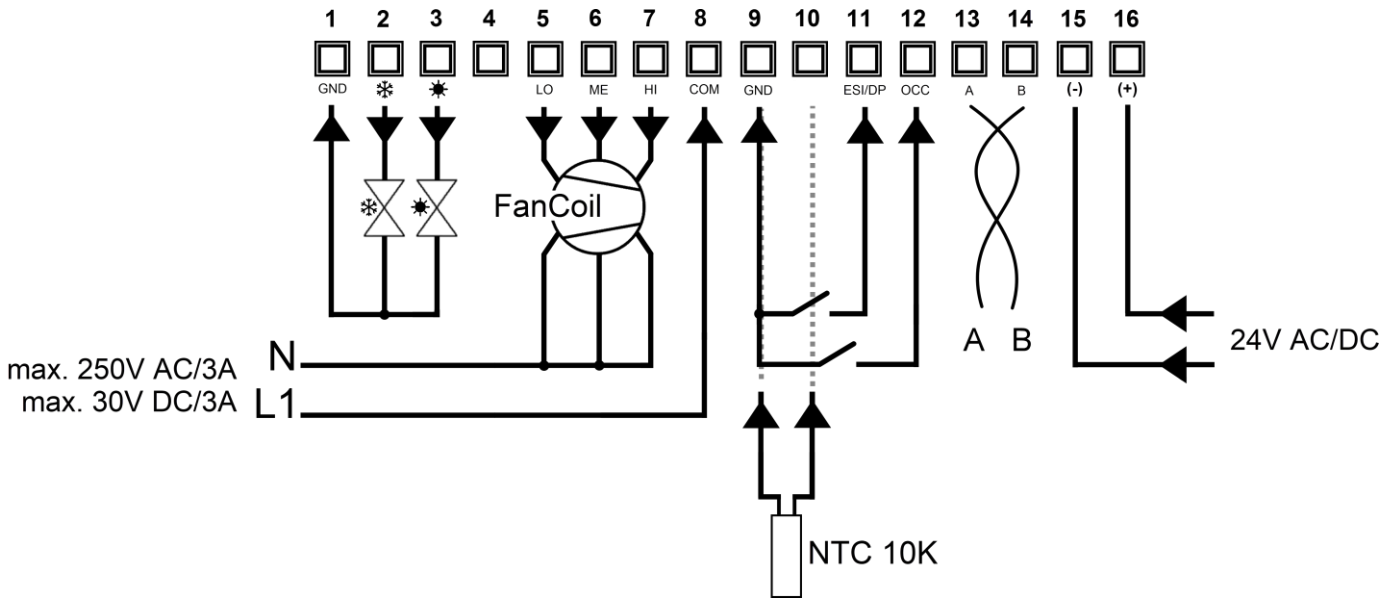

Power supply

When several BUS devices are supplied by one 24 V AC voltage supply, it is to be ensured that all “positive” operating voltage input terminals (+) of the field devices are connected with each other and all “negative” operating voltage input terminals (-) (=reference potential) are connected together (in-phase connection of field devices).

In case of reversed polarity at one field device, a supply voltage short-circuit would be caused by that device. The consequential short-circuit current flowing through this field may cause damage to it.

Therefore, pay attention to correct wiring.

Controller output signal

		4-pipe (default)	2-pipe	6WV – 6-way valve
Terminal 2	❄️	Cooling	Heating & Cooling	Heating & Cooling
Terminal 3	☀️	Heating		

Communication factory default

Modbus-adress:	1		
Communication-interface:	RS485	Communication-protocol:	Modbus-RTU
Baud Rate:	9600	Parity:	No parity
Data:	8 bit	Stop:	2 bit

» DISPLAY PANEL

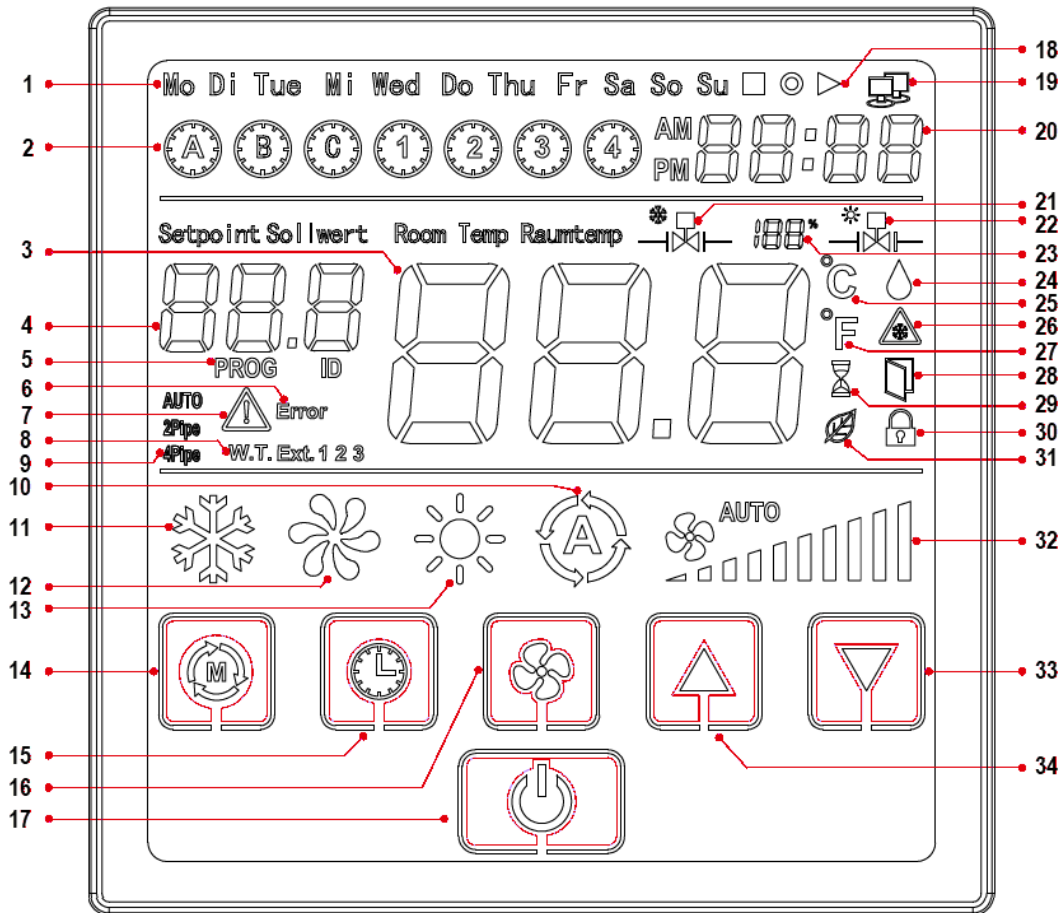

1 Week	8 External sensor used	15 Clock setting	22 Heating valve	29 Off-delay active
2 Scheduler	9 Fan coil type	16 Set fan speed	23 Valve opening	30 Key locked
3 Room temperature	10 Auto mode	17 Power ON/OFF	24 Dew point	31 Eco-Mode active
4 Setpoint	11 Cooling	18 Power-On options	25 Celcius	32 Fan stage
5 Program	12 Ventilation	19 Modbus active	26 Frost protection off	33 Temperature down
6 Error	13 Heating	20 Clock	27 Fahrenheit	34 Temperature up
7 Attention sign	14 Mode key	21 Cooling valve	28 Window open	

» FUNCTION DESCRIPTION

Device informationen		The device information (version and type number) are displayed on the start screen for a short time.
Communication		symbol flashes (If the device does not communicate via the bus, the symbol will be disappear after 10 seconds)
Parameter menu		To enter the parameter menu (i.e. for Modbus-communication settings): - Press and hold "mode" and up-button for 4 seconds. - Enter password: (default: 987) o Digit selection: mode-button o Arrow keys (▲/▼): increase / decrease value - Select parameter with arrow keys
Date/Time setting		- press and hold the Time/Calendar (15) and Temperature "Down" (34) buttons simultaneously for 5 seconds - parameterisable value starts to flash - year/month/day/hour can be set sequentially - value can be changed with the "Up" and "Down" buttons - confirmed with the time/calendar button



After parameter selection / setting, don't press any button for 3 seconds to save the settings.

No.	Parameter	Description	default
1	Modbus Adress	ID.1- ID.247	1
2	Baud rate	1 = 4800bps 2 = 9600 3 = 19200 4 = 38400	2
3	Parity	0 = none 1 = even 2 = odd	0
4	Stop Bits	1 = 1 Stopbit 2 = 2 Stopbits	2
5	Temperature Offset internal sensor	-5,0 K..+5,0 K	0
6	Temperatur Offset external sensor	-5,0 K..+5,0 K	0
7	Screensaver mode	0 = display button on / off 1 = room temperature and button on / off 2 = display clock, room temperature and button on / off 3 = display clock, room temperature / button on / off and set point 4 = display all status	0
8	7 day 4 periods (programmable)	0 = deactivated 1 = activated	0
9	Password	0..999	987
10	Factory reset	- Set parameter to 1 - Press mode key - Device is factory reset. <i>(Device stays in Parameter menu for Modbus configuration)</i>	0
11	Reserved	Reserved	0

The Fancoil controller is designed for fan coil units with 2- or 4-pipe systems for heating and cooling.

PI-controller 0..10 V

The manipulated variable is output as a proportional control signal. The type of valve used is set via the configuration registers.

6WV

With register address 304, a 6-way valve can also be selected as valve type. You can choose from 2..10 V / 2..10 V INV (Belimo), 0..10 V DN15 / DN15 INV, DN20 / DN20 INV (Sauter).

Operating mode

Press the "Mode Key"  , to adjust the mode cyclically (Cooling > Auto mode > Ventilating > Heating ...).

In 2-pipe configuration not available modes (depending on the change-over sensor's signal) will be skipped. In this case the user can select the available modes only.

Standby / ECO / ON

The Power-Button switches the device from Stand-by to ON. In Standby the display is off, but the control loop is actively monitoring the temperature and will activate the heating output if the room temperature drops below the frost protection threshold.

Pressing the button once switches the display on and the device to ECO mode. In ECO mode it controls the room temperature to the setpoint predefined by register 275 and 276 (0x0113, 0x0114). The display will show the average of both ECO Setpoint Temperatures (25+18 /2=21,5) and the leaf symbol to indicate the ECO mode. In ECO mode the setpoint is fixed and the device does not react to any button pressed by the user besides pressing the Stand-by /ECO/ON button a 2nd time. Then it will switch from ECO to comfort mode. To indicate that the Fancoil thermostat is in ECO mode it will show the leaf and the word ECO in the display.

In case an occupancy sensor is connected to one of the inputs the mode will change from ECO to Comfort as soon as the input becomes active and the previously used Setpoint will be restored and the leaf symbol will not be showing any more.

Temperature sensor input – temperature limiter and external sensor

The temperature sensor input (address 0x0152) can be used as change over sensor (addresses 0x012B and 0x012C) or as external temperature sensor.

Furthermore, it can also be used to limit the heating temperature (address 0x010A) and cooling temperature (address 0x010B). This is the case for floor heating systems, where the external sensor is embedded in the floor. In case the floor temperature will exceed a certain threshold the heating valve shall be closed to avoid damaging the floor or the pipes embedded in the floor.

Fan control

If the fan is configured to be 1-stage or 2-stage the selection will be adapted accordingly. In „ventilating mode“, the valves will be closed. If the fan speed  is set to Auto the steps are switched depending on the temperature difference between the setpoint value and the current temperature value.

In auto mode heating or cooling, the fan level is calculated from the output of the PI loop (control variable).

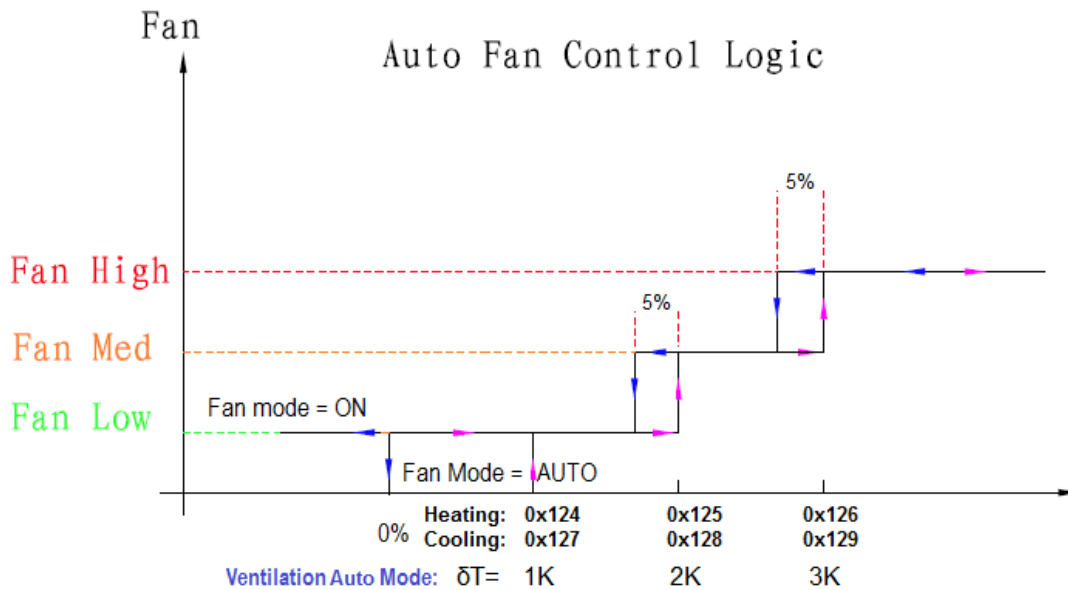

°F/°C selective

Temp display range is 32 °F..99 °F, respectively 0 °C..50 °C (factory default is °C). By simultaneously pressing the keys "▲" and "▼" the display of the unit system can be switched directly on the LCD.

Temperature offset correction (Register address 0x0106)

The internal sensor will be affected by the Thermostat's self-heating. As a consequence it would display a higher room temperature than the average of indoor temperature (real value). Item 5 & 6 of the parameter table does contain the correction of temperature offset (resolution 0,1 °C).

Set the Temperature set point range (Register address 0x0110 – 0x0112)

Press "▲" or "▼" key to adjust the temperature set point range. Factory default (°C) is 16 °C..30 °C, When °F has been selected Temp range is 60 °F..86 °F.

Key lock selection (Register address 0x010D)

If a key is pressed that is locked, the lock symbol  will appear for 2s and blink 2x but no further action is taken.

Power failure – Restart selection (Register address 0x010C)

Symbol Description



Keep thermostat switched OFF



Switch thermostat to last state before power failure (Record and Memorize)



Turn the thermostat ON

Storage during power loss



The status will be kept in EEPROM, while the power failure, so no data will be lost.

The setpoint is not saved. The standard setpoint after power-on reset applies, register address 271 (0x010F).

Occupancy (OCC)

If the input is configured for an Occupancy sensor. If the sensor indicates "UnOccupied" the current setpoint will be replaced by the Eco Mode Setpoint Temp. The display will show the leaf symbol and the lettering ECO to indicate the ECO mode. Once the room occupancy is detected again the previously used Setpoint will be restored and the leaf symbol will not be showing any more.

Window contact (ESI)

If the input is configured as window contact, the "Window open" Symbol will be displayed the thermostat will check every 3 seconds the input whether active. The cooling valve will be closed as long as the input will be active. The rest of the thermostat will work as usual, the user may

change the setpoint or the fan stage, but the valve outputs will remain in valve closed position. If configured the "Window open"  or the Dew

Point symbol  will be flashing. When the input will not be active, the thermostat's outputs return to normal operation and operates the outputs normally.

Sensor failure alarm

In case room NTC temp sensor is open or short, thermostat switches fan to medium and the valve to 50% (5V output, 50%). The display will show (blinking) error code: "E1" Thermostat will allow to control fan manually as well as the valve output using the "▲" or "▼" keys. Every operation of the "▲" or "▼" keys will decrement / increment the output voltage by 1V = 10% AND the PWM by 10%. The percentage is shown in the display.

Input Register				
Address	Access	Description	Register value \triangleq Value range	
0	0x000	R	Thermokon model identification	0xFF02 \triangleq LCF-2AO3DO
1	0x0001	R	Firmware-Version	e.g. 0x1110 \triangleq 1.1.1
2	0x0002	R	Back-Box Type	23 \triangleq 2AO3DO
3	0x0003	R	Value of the integrated temperature sensor °C / °F	0..500 \triangleq 0..50,0°C 300..1200 \triangleq +30,0..+120,0°F
4	0x0004	R	Fan-State 0b00000000 = OFF 0b00000001 = Fan stage low 0b00000010 = Fan stage medium 0b00000100 = Fan stage high 0b00001000 = Auto OFF 0b00001001 = Auto low 0b00001010 = Auto medium 0b00001100 = Auto high	
5	0x0005	R	VA1 State – output valve 1 cooling	0..1000 \triangleq 0..100%
6	0x0006	R	VA2 State – output valve 2 heating	0..1000 \triangleq 0..100%
7			Reserviert	
8	0x0008	R	External temperature sensor °C / °F	200..+1000 \triangleq -20,0..+100,0°C 0..2100 \triangleq 0,0..+210,0°F
9	0x0009	R	Failure status 0x00= no failure 0x01= control loop temperature sensor alarm 0x02= external temperature sensor high limit alarm – (cablebreak) 0x04= external temperature sensor low limit alarm – (short circuit) 0x08= change over sensor missing alarm	
10	0x000A	R	External input 1 – terminal 11 0 = Contact open, 1= Contact closed <i>(i.e. window contact, dew point sensor)</i>	0..1
11	0x000B	R	External input 2 – terminal 12 0 = Contact open, 1= Contact closed <i>(i.e. OCC Sensor, keycard-switch)</i>	0..1

		Holding Register				
		Address	Access	Description	Register value \triangle Value range	Default
General settings	256	0x0100	R/W	Customer set Device location identification	0..65535	0
	257	0x0101	R/W	LCD temperature Unit 0 =°C 1=°F (converted values)	0..1	0
	258	0x0102	R/W	Beeper Intensity 0=Off 1..5 (Volume)	0..5	5
	259	0x0103	R/W	Backlight intensity (operation)	0..100 \triangle 0..100%	80
	260	0x0104	R/W	Backlight intensity for screen saver	0..25	20
	261	0x0105	R/W	Backlight operating delay setting	1..255 \triangle 1..255 Sec. (on)	15
	262	0x0106	R/W	Internal Sensor Temperature Offset (added to measured value)	-50..50 \triangle -5,0..+5,0 [°C] -250..250 \triangle -25,0..+25,0 [°F]	0
	263	0x0107	R/W	external Sensor Temperature Offset (added to measured value)	-50..50 \triangle -5,0..+5,0 [°C] -250..250 \triangle -25,0..+25,0 [°F]	0
	264	0x0108	R/W	Display language 0= german 1= English 2= no wording	0..2	0
	265	0x0109	R/W	Individual passwords setting 001-999 default=987 000 = no password	000..999	987
	266	0x010A	R/W	External temperature (limiter) sensor high limit (338=3, for limiter)	-200..1000 \triangle -20,0..+100,0 [°C] 0..2100 \triangle 0,0..+210,0 [°F]	400 / 110
	267	0x010B	R/W	External temperature (limiter) sensor low limit (338=3, for limiter)	-200..1000 \triangle -20,0..+100,0 [°C] 0..2100 \triangle 0,0..+210,0 [°F]	0 / 320
	268	0x010C	R/W	Power failure 0= keep off after power-on-reset 1= return to last state after power failure 2= switch on after power-on-reset	0..2	1
	269	0x010D	R/W	Key-lock Once a locked key is pressed the LOCK symbol shall be displayed and blink twice. 0x00=unlocked 0x01=lock on/off 0x02=lock mode 0x08=lock fan speed 0x10=lock temp settings + / - 0x1F=lock all keystrokes		0
270	0x010E	R/W	Display settings 0b00000001= show setpoint (if no setpoint is shown, keys are locked) 0b00000010= show room temperature 0b00000100 = show valve symbol 0b00001000 = show PI-loop percentage 0bxxx10000 = show room temperature from register 0x205 (touch only) <i>(if only room temperature or setpoint is shown, then in big numbers)</i>		15	

		Holding Register				
		Address	Access	Description	Register value \triangle value range	default
Set-point settings	271	0x010F	R/W	Default Setpoint after Power On Reset	0..500 \triangle 0,0..+50,0 [°C] 300..1200 \triangle +30,0..+120,0 [°F]	210 / 700
	272	0x0110	R/W	Setpoint temperature lower limit	0..500 \triangle 0,0..+50,0 [°C] 300..1200 \triangle +30,0..+120,0 [°F]	160 / 600
	273	0x0111	R/W	Setpoint temperature upper limit	0..500 \triangle 0,0..+50,0 [°C] 300..1200 \triangle +30,0..+120,0 [°F]	300 / 860
	274	0x0112	R/W	Setpoint increment/decrement value	1..100 \triangle 0,1..10,0 [°C] 1..500 \triangle 0,1..50,0 [°F]	5 / 10
	275	0x0113	R/W	ECO mode temperature setpoint cooling	250..450 \triangle +25,0..45,0 [°C] 750..1100 \triangle +75,0..110,0 [°F]	300 / 860
	276	0x0114	R/W	ECO mode temperature setpoint heating	120..240 \triangle +12,0..24,0 [°C] 50..750 \triangle +5,0..75,0 [°F]	190 / 660

		Holding Register				
Address	Access	Description	Register value \pm Value range	default.		
PI-controller	277	0x0115	R	Controller mode Comfort: 0b0000 0000= Controller off (frost protection active, LCD off) 0b0000 0001= Controller auto mode (heating & cooling) 0b0000 0010= Controller heating mode only 0b0000 0011= Controller cooling mode only 0b0000 0100= ventilating (PI-loop controls fan stages only, valves closed) Regler-Modus ECO: 0b0001 0000= Controller off (Frost protection active) 0b0001 0001= Controller auto mode (heating&cooling) 0b0001 0010= Controller heating mode only 0b0001 0011= Controller cooling mode only 0b0001 0100= ventilating (PI-loop controls fan stages only, valves closed) HMI mode 0b1xxx xxxx = HMI Mode, controller OFF 0b1xxx xx01 = show symbol "ventilating" 0b1xxx xx10 = show symbol "heating" 0b1xxx xx11 = show symbol "cooling" 0b1xxx x1xx = show symbol " AUTO mode" 0b1xxx x110 = show "AUTO + heating" symbol 0b1xxx x111 = show "AUTO + cooling" symbol 0b1xxx x101 = show "AUTO + ventilating" symbol 0b1xxx 1xxx = reserved	1	
	278	0x0116	R/W	Fancoil Typ: 2- or 4-pipe 0b00000000=2-pipe: cooling + heating with change over 0b00000001=4-pipe: cooling + heating / (or if 6WV used)	1	
	279	0x0117	R/W	Fan stages and operation modes 0b00000000 = none (fan key is locked, the fan symbol will be faded on the LCD) 0bxxxx0001 = 1 fan stage 0bxxxx0010 = 2 fan stages 0bxxxx0011 = 3 fan stages 0b0001xxxx = During heating mode fan is disabled 0b0010xxxx = During cooling/ventilation mode fan is disabled 0b0011xxxx = during heating/ cooling mode fan is disabled	3	
	280	0x0118	R/W	Start fan at highest stage for () seconds	0..60 \pm 0..60 Sek.	0
	281	0x0119	R/W	Fan OFF-Delay 0= fan never stops 1..255 \pm 1..255 Min after valve closing fan stops for .. minutes.	15	
	283	0x011B	R/W	Deadband	1..100 \pm 0,1..10,0 [°C]	10
	284	0x011C	R/W	Heating Proportional Band Xp_heat	1..100 \pm 0,1..10,0 [°C]	20
	285	0x011D	R/W	Heating Integration Time Tn_heat	0..255 \pm 0..255 Minuten	30
	286	0x011E	R/W	Cooling Proportional Band Xp_cool	1..100 \pm 0,1..10,0 [°C]	20
	287	0x011F	R/W	Cooling Integration Time Tn_cool	0..255 \pm 0..255 Minuten	30
	288	0x0120	R/W	Minimal limit of the control variable heat	0..100 \pm 0..100 %	0
	289	0x0121	R/W	Maximal limit of the control variable heat	0..100 \pm 0..100 %	100
	290	0x0122	R/W	Minimal limit of the control variable cool	0..100 \pm 0..100 %	0
	291	0x0123	R/W	Maximal limit of the control variable cool	0..100 \pm 0..100 %	100
	292	0x0124	R/W	Fan stage 1 ON threshold control variable heat	0..100 \pm 0..100 %	5
	293	0x0125	R/W	Fan stage 2 ON threshold control variable heat	0..100 \pm 0..100 %	35
	294	0x0126	R/W	Fan stage 3 ON threshold control variable heat	0..100 \pm 0..100 %	70
	295	0x0127	R/W	Fan stage 1 ON threshold control variable cool	0..100 \pm 0..100 %	5
	296	0x0128	R/W	Fan stage 2 ON threshold control variable cool	0..100 \pm 0..100 %	35
	297	0x0129	R/W	Fan stage 3 ON threshold control variable cool	0..100 \pm 0..100 %	70
	298	0x012A	R/W	Frost protection temperature threshold	50..150 \pm +5,0..+15,0 °C 400..600 \pm +40,0..+60,0 °F	70/ 450
	299	0x012B	R/W	Change-Over Temperature Threshold for Heating	0..500 \pm 0..+50,0 °C 300..1200 \pm +30,0..+120,0 °F	300/ 860
	300	0x012C	R/W	Change-Over Temperature Threshold for Cooling (In case temperature is in between both thresholds the last state will be maintained)	0..500 \pm 0..+50,0 °C 300..1200 \pm +30,0..+120,0 °F	190/ 660
	301			Reserved		
	302			Reserved		
	303			Reserved		
	304	0x0130	R/W	Valve type selection, heating + cooling 4 = proportional (OV = 0% ..10V = 100%) 5 = invers proportional (OV = 100% ..10V = 0%) 6 = proportional Belimo 6 way 7 = proportional Sauter 6 way with Ø15mm 8 = proportional Sauter 6 way with Ø20mm	9 = proportional Belimo 6 way, counter direction 10 = proportional Sauter 6 way with Ø15mm, counter direction 11 = proportional Sauter 6 way with Ø20mm, counter direction 12 = no valve	4

Holding Register						
	Address	Access	Description	Register value \triangleq Value range	default	
Inputs	336	0x0150	R/W	Configuration external input 1, terminal 11 0 = no function 1 = Occupancy sensor (Open = Occupied) 2 = Occupancy sensor (Closed =Occupied) 3 = Window contact (Open = Window Open) 4 = Window contact (Closed = Window Open) 5 = Disable heating (Open = Heating disabled) 6 = Disable heating (Closed = Heating disabled) 7 = Disable cooling (Open = Disable Cooling) 8 = Disable cooling (Closed = Disable Cooling) 9 = Dew Point Sensor (Open = Dewpoint crossed, disable cooling) 10 = Dew Point Sensor (Closed = Dewpoint crossed, disable cooling)		0
	337	0x0151	R/W	Configuration external input 2 0 = No function 1 = Occupancy sensor (Open = Occupied) 2= Occupancy sensor (Closed =Occupied) 3 = Window contact (Open = Window Open) 4 = Window contact (Closed = Window Open) 5 = Disable heating (Open = Heating disabled) 6 = Disable heating (Closed = Heating Disabled) 7 = Disable cooling (Open = Disable Cooling) 8 = Disable cooling (Closed = Disable Cooling) 9 = Dew Point Sensor (Open = Dewpoint crossed, disable cooling) 10 = Dew Point Sensor (Closed = Dewpoint crossed, disable cooling)		0
	338	0x0152	R/W	Configuration Sensor Input 0 = none connected 1 = Change-Over Temp sensor (NTC10K) 2 = Ext. temp sensor (NTC10K) 3 = Temperature limiter		0
	339	0x0153	R/W	ESI (Energy Savings Input) – ON delay ON delay for ESI. Delays Energy stop by n seconds.	[s]	0
	340	0x0154	R/W	Occupation (OCC-input) – OFF- delay	0...65535 \triangleq 0...65535 [s]	1800

Holding Register						
	Address	Access	Description	Register value \triangleq Value range	default	
Timer	400	0x0190	R/W	Clock mode configuration 0=Don't show time in LCD 1=12h mode 2=24h mode	0..2	2
	401	0x0191	R/W	Weekday configuration 0=OFF 1=ON	0..1	1
	402	0x0192	R/W	Automatic Summer/winter time 0=OFF 1=EU automatic (last Sunday in March (+1h) - last Sunday in October (-1h) 2=US automatic (2nd Sunday in March (+1h) - 1st Sunday in November (-1h) 3=AUS automatic (First Sunday in October (+1h) - 1st Sunday in April (-1h) 4=BR automatic (First Sunday in November (+1h) - Third Sunday in February (-1h) 5=CHL automatic (Second Sunday in August (+1h) - Second Sunday May (-1h) 6=ISR (Friday before last Sunday in March + 1h) - Last Sunday in October (-1h) 7=MEX (First Sunday in April (+1h) - Last Sunday in October (-1)		1
	403	0x0193	R/W	Time channel A weekdays 0bxxxxxx1 Bit0: Monday 0bxxxxxx1x Bit1: Tuesday 0bxxxxx1xx Bit2: Wednesday 0bxxxx1xxx Bit3: Thursday 0bxxx1xxxx Bit4: Friday 0bxx1xxxxx Bit5: Saturday 0bx1xxxxxx Bit6: Sunday		0
	404	0x0194	R/W	Time channel A period 1: Start time hour	0..23 \triangleq 0 – 23h	0
	405	0x0195	R/W	Time channel A period 1: Start time minute	0..59 \triangleq 0 – 59m	0
	406	0x0196	R/W	Time channel A period 1: Set point	0..500 \triangleq 0..50,0°C 300..1200 \triangleq +30,0..+120,0°F	210/ 700
	407	0x0197	R/W	Time channel A period 1: ECO mode 0b00000001= Comfort 0b00010001=ECO		1
	408	0x0198	R/W	Time channel A period 2: Start time hour	0..23 \triangleq 0 – 23h	0
	409	0x0199	R/W	Time channel A period 2: Start time minute	0..59 \triangleq 0 – 59m	0
	410	0x019A	R/W	Time channel A period 2: Set point	0..500 \triangleq 0..50,0°C 300..1200 \triangleq +30,0..+120,0°F	210/ 700
	411	0x019B	R/W	Time channel A period 2: ECO mode 0b00000001=Comfort 0b00010001=ECO		1
	412	0x019C	R/W	Time channel A period 3: Start time hour	0..23 \triangleq 0 – 23h	0
	413	0x019D	R/W	Time channel A period 3: Start time minute	0..59 \triangleq 0 – 59m	0

Holding Register						
Address	Access	Description	Register value \triangle value range	default		
414	0x019E	R/W	Time channel A period 3: Set point	0..500 \triangle 0..50,0°C 300..1200 \triangle +30,0..+120,0°F	210/ 700	
415	0x019F	R/W	Time channel A period 3: ECO mode 0b00000001=Comfort 0b00010001=ECO		1	
416	0x01A0	R/W	Time channel A period 4: Start time hour	0..23 \triangle 0 – 23h	0	
417	0x01A1	R/W	Time channel A period 4: Start time minute	0..59 \triangle 0 – 59m	0	
418	0x01A2	R/W	Time channel A period 4: Set point	0..500 \triangle 0..50,0°C 300..1200 \triangle +30,0..+120,0°F	210/ 700	
419	0x01A3	R/W	Time channel A period 4: ECO mode 0b00000001=Comfort 0b00010001=ECO		1	
420	0x01A4	R/W	Time channel B weekdays 0bxxxxxx1 Bit0: Monday 0bxxxxx1x Bit1: Tuesday 0bxxxxx1xx Bit2: Wednesday 0bxxxx1xxx Bit3: Thursday 0bxxx1xxxx Bit4: Friday 0bxx1xxxx Bit5: Saturday 0bx1xxxxx Bit6: Sunday		0	
421	0x01A5	R/W	Time channel B period 1: Start time hour	0..23 \triangle 0 – 23h	0	
422	0x01A6	R/W	Time channel B period 1: Start time minute	0..59 \triangle 0 – 59m	0	
423	0x01A7	R/W	Time channel B period 1: Set point	0..500 \triangle 0..50,0°C 300..1200 \triangle +30,0..+120,0°F	210/ 700	
424	0x01A8	R/W	Time channel B period 1: ECO mode 0b00000001=Comfort 0b00010001=ECO		0	
425	0x01A9	R/W	Time channel B period 2: Start time hour	0..23 \triangle 0 – 23h	0	
426	0x01AA	R/W	Time channel B period 2: Start time minute	0..59 \triangle 0 – 59m	0	
427	0x01AB	R/W	Time channel B period 2: Set point	0..500 \triangle 0..50,0°C 300..1200 \triangle +30,0..+120,0°F	210/ 700	
428	0x01AC	R/W	Time channel B period 2: ECO mode 0b00000001=Comfort 0b00010001=ECO		0	
429	0x01AD	R/W	Time channel B period 3: Start time hour	0..23 \triangle 0 – 23h	0	
430	0x01AE	R/W	Time channel B period 3: Start time minute	0..59 \triangle 0 – 59m	0	
431	0x01AF	R/W	Time channel B period 3: Set point	0..500 \triangle 0..50,0°C 300..1200 \triangle +30,0..+120,0°F	210/ 700	
432	0x01B0	R/W	Time channel B period 3: ECO mode 0b00000001=Comfort 0b00010001=ECO		0	
433	0x01B1	R/W	Time channel B period 4: Start time hour	0..23 \triangle 0 – 23h	0	
434	0x01B2	R/W	Time channel B period 4: Start time minute	0..59 \triangle 0 – 59m	0	
435	0x01B3	R/W	Time channel B period 4: Set point	0..500 \triangle 0..50,0°C 300..1200 \triangle +30,0..+120,0°F	210/ 700	
436	0x01B4	R/W	Time channel B period 4: ECO mode 0b00000001=Comfort 0b00010001=ECO		0	
437	0x01B5	R/W	Time channel C weekdays 0bxxxxxx1 Bit0: Monday 0bxxxxx1x Bit1: Tuesday 0bxxxxx1xx Bit2: Wednesday 0bxxxx1xxx Bit3: Thursday 0bxxx1xxxx Bit4: Friday 0bxx1xxxxx Bit5: Saturday 0bx1xxxxx Bit6: Sunday		0	
438	0x01B6	R/W	Time channel C period 1: Start time hour	0..23 \triangle 0 – 23h	0	
439	0x01B7	R/W	Time channel C period 1: Start time minute	0..59 \triangle 0 – 59m	0	
440	0x01B8	R/W	Time channel C period 1: Set point	0..500 \triangle 0..50,0°C 300..1200 \triangle +30,0..+120,0°F	210/ 700	
441	0x01B9	R/W	Time channel C period 1: ECO mode 0b00000001=Comfort 0b00010001=ECO		0	
442	0x01BA	R/W	Time channel C period 2: Start time hour	0..23 \triangle 0 – 23h	0	
443	0x01BB	R/W	Time channel C period 2: Start time minute	0..59 \triangle 0 – 59m	0	
444	0x01BC	R/W	Time channel C period 2: Set point	0..500 \triangle 0..50,0°C 300..1200 \triangle +30,0..+120,0°F	210/ 700	

Timer

Holding Register						
	Address	Access	Description	Register value \triangle Value range	default	
Timer	445	0x01BD	R/W	Time channel C period 2: ECO mode 0b00000001=Comfort 0b00010001=ECO		0
	446	0x01BE	R/W	Time channel C period 3: Start time hour	0..23 \triangle 0 – 23h	0
	447	0x01BF	R/W	Time channel C period 3: Start time minute	0..59 \triangle 0 – 59m	0
	448	0x01C0	R/W	Time channel C period 3: Set point	0..500 \triangle 0..50,0°C 300..1200 \triangle +30,0..+120,0°F	210/ 700
	449	0x01C1	R/W	Time channel C period 3: ECO mode 0b00000001=Comfort 0b00010001=ECO		0
	450	0x01C2	R/W	Time channel C period 4: Start time hour	0..23 \triangle 0 – 23h	0
	451	0x01C3	R/W	Time channel C period 4: Start time minute	0..59 \triangle 0 – 59m	0
	452	0x01C4	R/W	Time channel C period 4: Set point	0..500 \triangle 0..50,0°C 300..1200 \triangle +30,0..+120,0°F	210/ 700
	453	0x01C5	R/W	Time channel C period 4: ECO mode 0b00000001=Comfort 0b00010001=ECO		0
	454	0x01C6	R/W	Active Time Channel 0bABC1234 with binary value = 1 for active channel (z.B. 0x01000100 = A-2)		0
	464	0x01D0	R/W	Make next day(s) holiday 0bxxx00000= None 0bxxx00001 ...0bxxx11111 days of holidays (next n-days (starting next 0:00) forces the coming 1...31 days to be treated as the day specified by the 3 MSB. Does overwrite the calendar. 0b000xxxxx = use ECO setting 0b001xxxxx = set day = Mo 0b010xxxxx = set day = Tu 0b011xxxxx = set day = Wed 0b100xxxxx = set day = Thu 0b101xxxxx = set day = Fr 0b110xxxxx = set day = Sat 0b111xxxxx = set day = Sun		0

Holding Register						
	Address	Access	Description	Register value \triangle value range	default	
Realtime Clock	496	0x01F0	R/W	system time year	2000..2099	2019
	497	0x01F1	R/W	system time month	1..12	1
	498	0x01F2	R/W	system time day	1..31	1
	499	0x01F3	R/W	system time hour	0..23	0
	500	0x01F4	R/W	system time minute	0..59	0
	501	0x01F5	R/W	system time seconds	0..59	0

Holding Register (operation to override FC from modbus)					
Address	Access	description	Register value \pm Value range	default	
Special	512	0x0200	R/W	Active fan speed setting 0b00000000 = OFF 0b00000001 = Stage low 0b00000010 = Stage medium 0b00000100 = Stage high 0b00001000 = Auto OFF 0b00001001 = Auto low 0b00001010 = Auto medium 0b00001100 = Auto high	0
	513	0x0201	R/W	setpoint temperature 0..500 \pm 0..+50,0 [°C] 300..1200 \pm +30..+120,0 [°F]	0
	514	0x0202	R/W	Controller mode Comfort: 0b0000 0000= controller off (<i>Frost protection active</i>) 0b0000 0001= controller auto mode (<i>heating + cooling</i>) 0b0000 0010= controller heating mode only 0b0000 0011= controller cooling mode only 0b0000 0100=ventilating only (<i>PI loop controls fan stages only, valves closed</i>) Controller mode ECO: 0b0001 0000=Regler aus (Frostschutz aktiv) 0b0001 0001=Regler Automatik-Modus (<i>Heizen&Kühlen</i>) 0b0001 0010=Regler NUR Heizen 0b0001 0011=Regler NUR Kühlen 0b0001 0100=NUR Belüftung (<i>PI-Regler steuert die Lüfterstufen, Ventile sind geschlossen</i>) HMI mode 0b1xxx xxxx = HMI Mode, controller OFF 0b1xxx xx01 = show symbol "ventilating" 0b1xxx xx10 = show symbol "heating" 0b1xxx xx11 = show symbol "cooling" 0b1xxx x1xx = show symbol "AUTO mode" 0b1xxx x110 = show "AUTO + heating" symbol 0b1xxx x111 = show "AUTO + cooling" symbol 0b1xxx x101 = show "AUTO + ventilating" symbol 0b1xxx 1xxx = reserved	0
	515	0x0203	R/W	Active symbols 0x00= show none 0x01= show ECO-leaf 0x02= show dew point 0x04= show frost protect 0x08= show window open 0x10= show attention symbol 0x20= show hourglas 0x40= show lock -symbol 0x80= show ECO-writing	0
	516	0x0204	R/W	Control Variable Y% (HMI Mode) If output is 2-point, output will be ON for control variable >5%	0..100
	517	0x0205	R/W	Room temperature on LCD (HMI Mode)	0..500 \pm 0..+50,0 [°C]

» MOUNTING ADVICE/ DIMENSIONS (MM)

For installing or maintenance, please make sure the power is disconnected. Fix the thermostat base plate to the wall through the four screw holes with distance between axes of 60 mm. Fasten base plate and front cover. Do not press the panel in order to protect LCD.

