

JOY HC AO2DO | HC 3AO | RS485 Modbus

Room Regulator (from Version 2.6.x)

thermokon[®]
HOME OF SENSOR TECHNOLOGY

Datasheet

Subject to technical alteration
Issue date: 01.05.2023 • A125

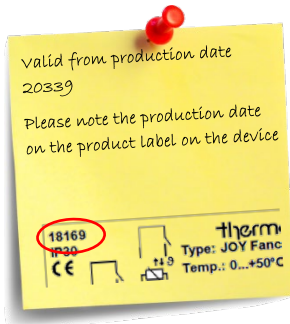

» APPLICATION

JOY HC AO2DO (85..260 V ~)

Room thermostat in an appealing design for heating/cooling (230 V) and controlling a 6-way valve. Used for individual control of temperature in commercial and residential buildings. The device combines a modern design with a 2,5" touch surface, which enables the single room controller to be used intuitively. 3 time channels with 4 periods of time can be configured via the menu. This device is suitable for a flush mount box.

JOY HC 3AO (24 V ~/=)

Modern design, flush mounting room thermostat. Used for individual control of temperature in commercial, industrial and residential buildings. It is tailored for two-pipe and four-pipe units with two-wire electric valves and controlling a 6-way valve. The device combines a modern design with a 2,5" LCD and a touch-sensitive surface, 3 time program options each with 4 time periods options.

» SECURITY ADVICE – CAUTION



The installation and assembly of electrical equipment should only be performed by authorized personnel. The product should only be used for the intended application. Unauthorised modifications are prohibited! The product must not be used in relation with any equipment that in case of a failure may threaten, directly or indirectly, human health or life or result in danger to human beings, animals or assets. Ensure all power is disconnected before installing. Do not connect to live/operating equipment.



CAUTION! Risk of electric shock due to live components within the enclosure, especially devices with mains voltage supply (usually between 90..265 V).

Please comply with:

- Local laws, health & safety regulations, technical standards and regulations
- Condition of the device at the time of installation, to ensure safe installation
- This data sheet and installation manual

» PRODUCT TESTING AND CERTIFICATION



Declaration of conformity

The declaration of conformity of the products can be found on our website <https://www.thermokon.de/>

» NOTES ON DISPOSAL



As a component of a large-scale fixed installation, Thermokon products are intended to be used permanently as part of a building or a structure at a pre-defined and dedicated location, hence the Waste Electrical and Electronic Act (WEEE) is not applicable. However, most of the products may contain valuable materials that should be recycled and not disposed of as domestic waste. Please note the relevant regulations for local disposal.

» MOUNTING ADVISE ROOM SENSORS

The Accuracy of the room sensors are influenced by the technical specifications as well as the positioning and the installation type.

During Assembly:

- Seal mounting box (if present).
- Installation type, air draught, heat source, radiation heat or direct sunlight can affect the measurement.
- Bulding material specific properties of the installation place (*brick-, concrete-, partition wall, cavity wall, ...*) can affect the measurement. (e.g.: *Concrete accepts room temperature variation slower than cavity walls*)

Assembly not recommendet in...

- Air draught (e.g.: close to windows / doors / fans ...)
- Near heating sources,
- Direct sunlight
- Niches / between furniture / ...

» MOUNTING ADVICES

Plasterboard boxes shall be covered by wall paper or paint to avoid that the plasterboard box's front rim will be partially visible underneath JOY. Maybe consider using white plasterboard boxes (i.e. Kaiser 9063-77).

» APPLICATION NOTICE

Software	Software-description on https://www.thermokon.de/
MicroSD-Card	Data storage device for Update, Upgrade or configuration - FAT-filesystem required - NTFS and exFAT filesystems are not supported!
Bootloader	A MicroSD-card Bootloader for loading applications (Update, Upgrade) or configurations is integrated in the device. <i>active bootlader = ring illumination blinks (1 sec. cycle), display is not triggered!</i>
Firmware Update	- Remove upper part, insert a microSD-card with valid Update file, mount upper part. - Valid update file is recognized and the update process is started (ring illumination blinks in a 300ms cycle) - New application is started automatically after Update (approx. 20-30 sec.). - Remove upper part, to remove MicroSD-card from the device!
Device Configuration	- Remove upper part, insert a microSD-card with device configuration file, mount upper part. - Configuration file is recognized and the device is configured. - Device ready for operation. - Remove upper part, to remove MicroSD-card from the device!

The parameters for the display, set point and the controller can only be changed via the configuration software.

» NOTES ON THE UPDATE FUNCTION



An update of the device software is only possible within the version main numbers.

3.0.2 ▶ 3.0.11 ✓

2.6.6 ▶ 2.3.0 ✓

2.x ▶ 3.x ✗

2.x ▶ 1.x ✗

» CONFIGURATION VIA UCONFIG | MICROSD-CARD OR MODBUS



Configuration software:

uConfig | Windows 10 is required to use the uConfig configuration software

The JOY room thermostat can be parameterised using the uConfig configuration software. An SD card is used to transfer the created configuration file to the device. For BUS devices, a live configuration can also be performed via the BUS interface.

The installer for the configuration software can be found in the Download-Section on our website. The installer retrieves all necessary files and plug-ins from our web server. In this version an update function is integrated in the software.

Download-Section

» **TECHNICAL DATA**» **JOY HC AO2DO | HC 3AO**

Measuring values	temperature, humidity (<i>optional</i>)	
Network technology	RS485 Modbus RTU, Fail-safe Biasing required	
Measuring range temp	0..+50 °C	
Accuracy temperature	±1 K (typ. at 21 °C)	
Measuring range humidity (<i>optional</i>)	0..100% rH non-condensing	
Accuracy humidity (<i>optional</i>)	±2% between 10..90% rH (typ. at 21 °C)	
Control functions	setpoint adjustment +0..+50 °C	
Display	LCD 60x44 mm, 240x160 px, white backlighting	
Functions	integrated PI- and 2-point-/ 3-point-controllers, 2nd control loop: 2-point controller	
Enclosure	PC, glass, optional black or white	
Protection	IP30 according to EN 60529	
Connection electrical	Terminal 1..8 terminal block max. 1,5 mm ²	Terminal 9..12 terminal block max. 1.0 mm ²
Ambient condition	0..+50 °C, max. 85% rH non-condensing	
Weight	195 g	
Mounting	flush mounted with standard EU box (Ø=60 mm)	

» **JOY HC AO2DO**

Output voltage	0..10 V =, max. load 5 mA (for 6-way valves)	
Output switch contact	2x normally open contacts (heating/cooling), 240 V max. load 500 mA	
Power supply	85..260 V ~	
Power consumption	max. 3 VA (260 V ~)	
Inputs	DI1 input for NTC 10 K or floating contact	DI2 digital input for non-floating contact (230 V ~)

» **JOY HC 3AO**

Output voltage	3x 0..10 V, max. load 5 mA, 6-way valve control, heating & cooling)	
Power supply*	24 V = (±10%) or 24 V ~ (±10%) SELV	
Power consumption	max. 2,5 W (24 V =)	
Inputs	DI 1 1 input for NTC10K or floating contact	DI 2 input for floating contact

***Power supply**

When several BUS devices are supplied by one 24 V AC voltage supply, it is to be ensured that all "positive" operating voltage input terminals (+) of the field devices are connected with each other and all "negative" operating voltage input terminals (-) (=reference potential) are connected together (in-phase connection of field devices).

In case of reversed polarity at one field device, a supply voltage short-circuit would be caused by that device. The consequential short-circuit current flowing through this field may cause damage to it.

Therefore, pay attention to correct wiring.

» **FUNCTION DESCRIPTION – CONTROLLER**

JOY HC AO2DO (85..260 V ~)	JOY HC 3AO (24 V ~/=)
PI controller (PWM) & 2-point/3-point controller (configurable)	PI controller (0..10 V)

6WV (PI-controller 0..10 V) (all types)

The manipulated variable is output as a proportional control signal at the output for the 6-way valve. The type of valve used is set via the configuration software. You can choose from 2..10 V / 2..10 V INV (Belimo), 0..10 V DN15 / DN15 INV, DN20 / DN20 INV (Sauter). There is also the possibility of a freely parameterizable 6-way valve (generic 6WV).

Heating/ cooling with 2-point-/ 3-point-controller (only HC AO2DO)

In the case of temperature control, the 2-point controller only knows the switching states heating ON and heating OFF. The 3-point controller also knows the switching state of cooling. Two - and three-point controller work with a hysteresis.

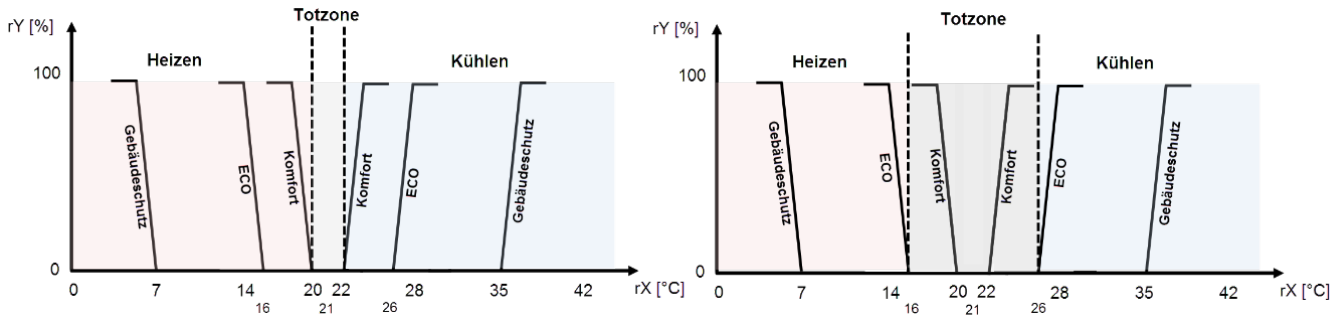

Heating/ cooling with PI-controller (PWM) (only HC AO2DO)

The time response of the PI control loop depends on the control parameters xp for the proportional area and tn for the reset time of the integral range. In case of an error, the P portion immediately changes the position value proportionally to the error variable, while the integral portion takes effect after a certain time.

The resulting actuating variable is output as a pulse-width-modulated signal directly to the outputs.

Heating/ cooling with PI-controller (0..10 V) (only HC 3AO)

The time response of the PI control loop depends on the control parameters xp for the proportional area and tn for the reset time of the integral range. In case of an error, the P portion immediately changes the position value proportionally to the error variable, while the integral portion takes effect after a certain time.

The resulting manipulated variable is output as an analogue 0..10 V signal directly to the outputs.

» **DISPLAY**

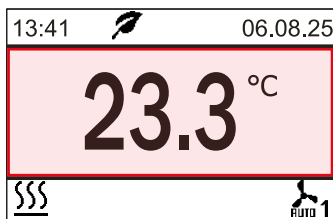

Value Screen
internal sensor values
external sensor values (configurable)

(additional humidity value optionally configurable)

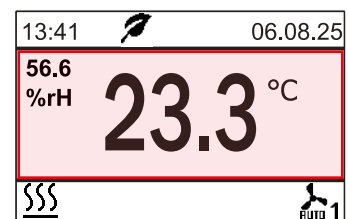

Header (value/ symbol display)
Time, weekday, date, ECO symbol (mode dependent)
Alarm symbol (higher priority than ECO-Symbol)

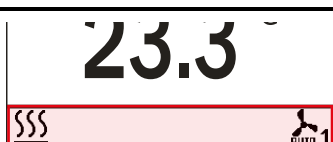

Footer (symbol display)
Symbols for heating/cooling mode, occupancy, window contact, etc.

The symbol „Timechannel active“ is only shown when a time channel is active.

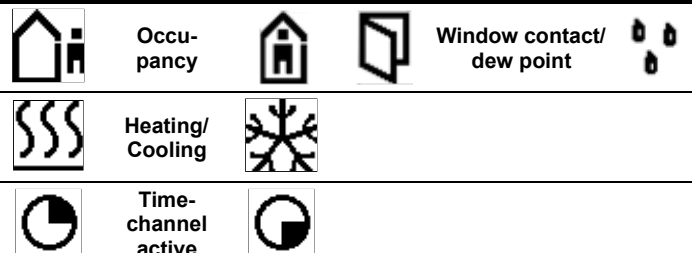

» FUNCTION DESCRIPTION – BUTTONS

On the touch surface, there are adjustment options for setpoint and fan speed regulation.

While pressing these buttons, the white ring-LED of the Power-button lights up for visual feedback.

Setpoint change (setpoint range $\pm 3\text{ }^{\circ}\text{C}$, default, configurable).



Power button for Standbymode, or Presence key*



*If the key is used as a presence key at the same time, the key must be pressed for at least 3s, in all other cases a short press is sufficient.

3 seconds without any interaction, the display returns back to main screen.

Standby mode (not compatible with Keycard-switch function)

In standby mode the display and all outputs are switched off (controller deactivated). The frost and heat protection monitoring remains active.

Navigation Parameternu
(up, down, left, right)

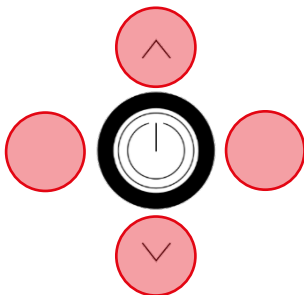

Open submenu (right)
In header left to leave the submenu

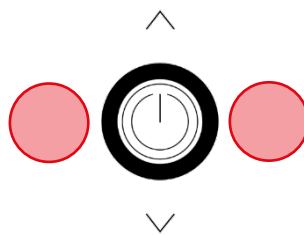

Confirmation



» DIAGNOSTICS MENU

To access the diagnostics menu, select the header in the startscreen of the parameter menu, and press the ENTER key. Here you will find various information, such as device type, software version, state of the inputs and outputs and controller state (current manipulated variable).

» PARAMETER MENU – MODBUS INTERFACE

The configuration menu is activated by simultaneously pressing the buttons “up” (A) and “down” (C) for at least 5 seconds.

The menu is enabled during the first 60 minutes after switching on the supply voltage as long as the device is not actively involved in Modbus communication. As soon as the device receives a valid request addressed to the device from a DDC, access to the menu is blocked. Without valid communication, access is blocked after 60 minutes!

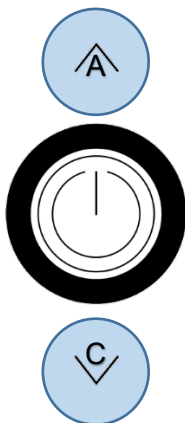

Modbus settings		
Address	◀-/▶	32
Baudrate	◀-/▶	19200
Parity	◀-/▶	Even

Address (default: 32)

Adjustable address (1-247)

Baud rate (default: 19200)

9600Bd | 19200Bd | 38400Bd | 57600Bd

Parity (default: even)

Non | odd | even

» CONFIGURATION

» Paramettermenu

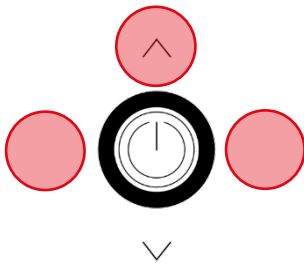

Access to Paramettermenu:
Press buttons for 3 seconds simultaneously

Menu
Timechannels
Time/Date
Sensor settings
Common settings

If no entry is made for 8 minutes, the parameter menu is left automatically.

» MENU → TIME CHANNELS

Menu
Timechannels
Time/Date
Sensor settings
Common settings

Up to 3 time channels with 4 time periods each can be parameterized. The time channels are prioritized, channel 3 has the highest priority.

Timechannels
Timechannel 1 Mo - Fr
Timechannel 2
Timechannel 3

Timechannels/Timer1
from day <-/+> Mo
to day <-/+> Fr
1: 06:00h -A - 22.0° ✓▶
2: 08:30h - 1 - 20.0° ✓▷
3: 16:00h -A - 22.0° ✓▷
4: 22:30h - 0 - 22.0°ECO ✓▷

Periods/Period1
Start <-/+> 06:00h
Fan <-/+> AUTO
Temp <-/+> 22.0°
ECO-Mode ✓

Time Channel

Time period within one week configuration ◀- / +▶ via button left / right 4 periods

Periods

Start – configuration start setpoint (24h format)

Fan – selection fanstage (depends on type)

Temperatur – setpoint (in °C or °F depends on configuration)

ECO mode – In ECO mode, the dead zone between heating and cooling is automatically set to the ECO dead zone configured in the "General Settings" menu (default: 10 K).

» MENU → TIME/DATE

Menu
Timechannels
Time/Date
Sensor settings
Common settings

In the Time/ Date menu the time, date and the display format can be configured.

Datetime setting/Time
Hour <-/+> 13
Minute <-/+> 07
12h/24h <-/+> 24h
Daylight saving <-/+> CET
Date

Datetime setting/Date
Day <-/+> 12
Month <-/+> 08
Year <-/+> 15
Presentation <-/+> T.M.J

Default settings:
24h display format
Daylight savings settings (CET)
Date presentation Day.Month.Year

The room thermostat is equipped with a real-time clock (needs to be set during commissioning).

» MENU → SENSOR SETTINGS

Menu
Timechannels
Time/Date
Sensor settings
Common settings

Offset correction settings for internal and external sensor value.
Value display of internal and external temperature sensors

Sensor settings
Offset int. <-/+> 0.6 K
Value int. 22.1°C
Offset ext. <-/+> 0.2 K
Value ext. 22.1°C
Unit <-/+> Celsius

Unit – Setting the temperature unit in celsius / fahrenheit.

» MENU → COMMON SETTINGS

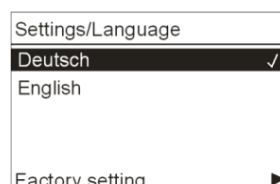
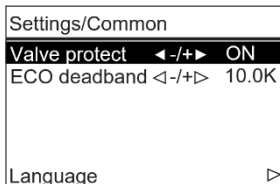
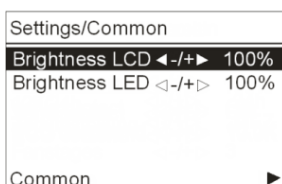
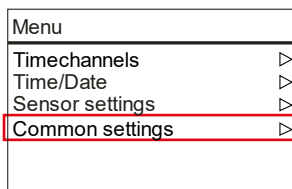

Common device settings:

- Brightness
- Valve protection
- ECO deadband
- Language
- Factory setting (reset)

Valve protection

A valve protection function actuates the heating and cooling valves regularly to prevent locking during non-usage times. The function is executed fridays at 11.00 (heating valve) and 11.15 (cooling valve). The corresponding valve is triggered for 5 minutes, if not activated during the last 96 hours.

Brightness

Configuration of the LCD brightness/ LED ring brightness during button operation/ usage.

ECO deadband

The dead band can be adjusted (default 10.0 K) * further information in the software specification file

Factory setting

By selecting "Factory setting", the room thermostat will be reset and restore the device to factory default settings.

» INPUTS

Up to 2 inputs are configurable for functions such as windows contact, dew point, occupancy, change-over or external sensor option.

The overview of possible combinations can be found in the software specification of the JOY.

Sensor (NTC10K)	The value of an external sensor will be shown if connected and configured accordingly. In this case, the room thermostat controls according to the external sensor. Alternatively, an external temperature sensor can be used at the universal input to protect floor heating. If a configured temperature is exceeded, the heating sequence is suspended.
Change-Over DI	Which controller is active depends on the state of the Change-Over contact. (Factory default: contact open heating controller active, contact closed cooling controller active). The terminals 4 and 5 are used as outputs for heating resp. cooling.
Change-Over Sensor	The Change-Over Sensor is used for switching between heating and cooling mode automatically. If the temperature is below 22 ° C, the controller is in cooling mode. If it is above 25 ° C, it is a heating mode. If an input is configured as a change-over, the room thermostat is automatically in 2-pipe operating mode and both outputs (terminals 4 and 5) are used as outputs for heating resp. cooling.
Window contact/Energy hold off	If a window contact is enabled via the digital input, the reference will switch to a setback set point (Heat SP/Cool SP).
Dewpoint	An active dewpoint contact locks the cooling controller.
Occupancy	If occupancy-function is active, the symbol will be displayed automatically. In state of "unoccupied" the heating set point is reduced by 2K (default setting) resp. the cooling set point raised by 2K.
Keycard-Switch	When the card is not inserted, the device is switched in sleep mode. Operation of the keys is locked, the display is switched off and the controller adjusts to the nominal values of the "unoccupied"-State.
Alarm contact	An alarm symbol can be shown in the header of the display. The backlight flashes when the alarm is active. This symbol is in the same position as the ECO symbol. The alarm symbol has a higher priority and overwrites the ECO symbol!

» CONNECTION PLAN

JOY HC AO2DO (85..260 V ~)

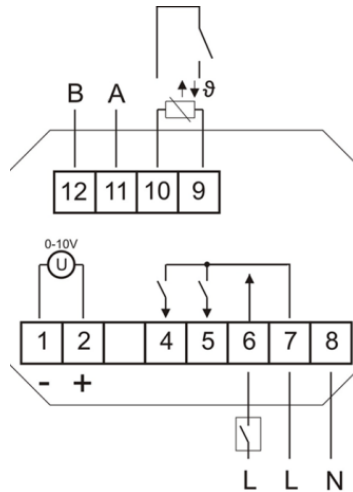

1 GND (6-way valve)
2 0..10 V (6-way valve)

4 Cooling
5 Heating
6 Digital Input 2 (230V)
7 L
8 N
9 Digital Input 1 (or NTC10K)
10 GND DI 1
11 Modbus A
12 Modbus B

JOY HC 3AO (24 V ~/=)

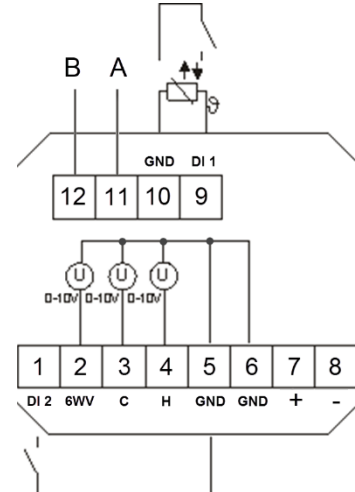

1 Digital Input 2
2 6-way valve (0..10 V)
3 Cooling (0..10 V)
4 Heating (0..10 V)
5 GND DI2
6 GND
7 24 V = ($\pm 10\%$) or 24 V ~ ($\pm 10\%$)
8 GND
9 Digital Input 1 (or NTC10K)
10 GND DI 1
11 Modbus A
12 Modbus B

Note: Parallel connection of the potential-loaded inputs is not permitted!

If the operating mode (change-over DI) of several devices is to be switched together by one contact, the potential-free 230V input must be used (DI2, only possible with the 230V version). It must be ensured that the same phase is used for jointly switched devices.

» DIMENSIONS (MM)

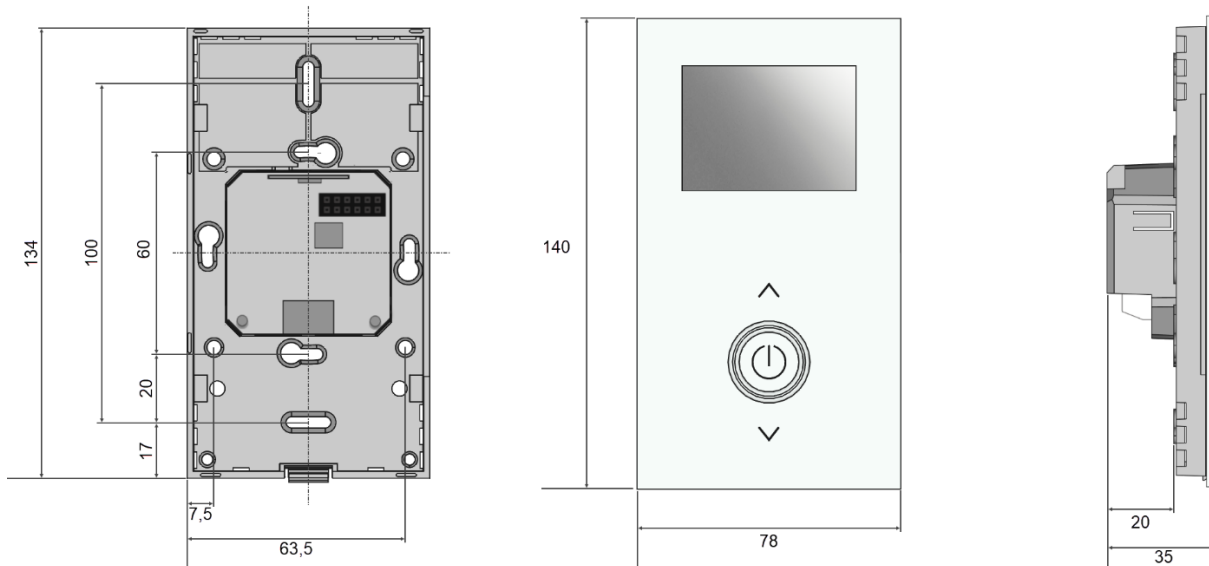

» ACCESSORIES (OPTIONAL)

Frame for surface mounting JOY pure white
Frame for surface mounting JOY black
Decorative frame pure white for JOY
Decorative frame black for JOY
MicroSD card 2GB

Item No. 760201
Item No. 760951
Item No. 681452
Item No. 740951
Item No. 500098

RS485 Biasing Adapter
USB RS485 Modbus RTU Logger
Converter RS485 Modbus - USB

Item No. 811378
Item No. 809917
Item No. 668293