

MCS-SR Temp_rH

EasySens temperature & relative humidity compact sensor

thermokon[®]
HOME OF SENSOR TECHNOLOGY

Datasheet

Subject to technical alteration
Issue date: 21.08.2023 • A122



» APPLICATION

EnOcean Multi-compact (room) temperature and humidity sensor. Ideal for retrofit applications in hotel rooms or office spaces to monitor temperature and humidity. The device can be mounted using adhesive tape (included) or screws and transmits the measured values to receivers or gateways.

» SECURITY ADVICE – CAUTION



The installation and assembly of the device should only be performed by authorized personnel.

The product should only be used for the intended application. Unauthorised modifications are prohibited! The product must not be used in relation with any equipment that in case of a failure may threaten, directly or indirectly, human health or life or result in danger to human beings, animals or assets. Ensure all power is disconnected before installing. Do not connect to live/operating equipment.

Please comply with:

- Local laws, health & safety regulations, technical standards and regulations
- Condition of the device at the time of installation, to ensure safe installation
- This data sheet and installation manual

» ENOCEAN BASIC INFORMATION

EnOcean Geräte werden nicht für die Verwendung im Zusammenhang mit Sicherheitsfunktionen empfohlen.

When designing EnOcean networks, always consider the local limitations, damping of radio signals and required communication paths. **Walls, furniture, objects and even the human bodies damp signals.** Perform a signal range test before mounting EnOcean devices and design in a buffer for the signal. EnOcean devices are not recommended for the use in context with safety functions.

» PRODUCT TESTING AND CERTIFICATION



Declaration of conformity

The declaration of conformity of the products can be found on our website <https://www.thermokon.de/>

» NOTES ON DISPOSAL



As a component of a large-scale fixed installation, Thermokon products are intended to be used permanently as part of a building or a structure at a pre-defined and dedicated location, hence the Waste Electrical and Electronic Act (WEEE) is not applicable. However, most of the products may contain valuable materials that should be recycled and not disposed of as domestic waste. Please note the relevant regulations for local disposal.

» GUIDELINES FOR DEVICES WITH SOLAR ENERGY STORAGE

Due to the energy-optimized EnOcean radio technology used in "EasySens®" wireless sensors, the devices can work without batteries and self-charge themselves using electric energy generated by integrated solar cells. This makes the devices almost maintenance free and environmentally sound due to not having to replace batteries.

For optimum use, the device should be mounted in a location with sufficient ambient brightness. Minimum illumination of 200 lx (artificial light or ambient) is required for at least 3 to 4 hours each day. (The health and safety regulations at work require a minimum illumination of 500 lx for office workplaces).

The solar cell should be mounted facing towards the window direction if possible. If the device has a temperature sensor, then even periodic direct sun radiation should be avoided due to incorrect false temperature readings.

The mounting position should be selected so that the device will not be obstructed in the future: for example by placement areas, additional furniture or roll-fronted cupboards.

The sensor is supplied in an operational state. If the sensor has been stored in darkness for longer periods, the internal solar energy storage will most likely need to be recharged. This would normally happen automatically during commissioning or during initial start up in ambient light. If the initial charge is not sufficient, the sensor will reach its full operating state up to 3 to 4 days, if the requirements for minimum illumination per day are met. The sensor will then transmit continuously in darkness as specified f (2/3 days on factory default telegram timing). Depending on the application it is also possible for the devices to operate in darker rooms (with brightness <100 lx) by using the battery back-up option. Batteries to be used are listed in accessories.

The operating time when using batteries will depend on the transmission frequency as well as the component aging and the self-discharge of the battery. Standard operating time will be several years on factory default telegram timing. Changing of the device from solar to battery operation is done automatically by simply adding a battery to the device.

» INFORMATION ABOUT EASYSSENS® (RADIO) / AIRCONFIG GENERAL USAGE



EasySens® - airConfig

Basic information about EasySens® radio and about general usage of our airConfig software, please download from our website.

» OVERVIEW OF THE RADIO TELEGRAMS



EEP

The structure of the data contained in the telegram can be found in the EEP (EnOcean equipment profile) list provided by the EnOcean Alliance.

» MOUNTING ADVISE ROOM SENSORS

The Accuracy of the room sensors are influenced by the technical specifications as well as the positioning and the installation type.

During Assembly:

- Seal mounting box (if present).
- Installation type, air draught, heat source, radiation heat or direct sunlight can affect the measurement.
- Building material specific properties of the installation place (*brick-, concrete-, partition wall, cavity wall, ...*) can affect the measurement. (*e.g.: Concrete accepts room temperature variation slower than cavity walls*)

Assembly not recommendet in...

- Air draught (e.g.: close to windows / doors / fans ...)
- Near heating sources,
- Direct sunlight
- Niches / between furniture / ...

» APPLICATION NOTICE FOR HUMIDITY SENSORS

At regular environmental condition, it is recommended to calibrate the sensor* annually to check the compliance with the accuracy required in the application. The following conditions can damage the sensor element or lead in long term to loss of the specified accuracy:

- Mechanical stress
- Contamination (e.g. dust / fingerprints)
- Aggressive chemicals
- Ambient conditions (e.g. condensation on measuring element)



Do not touch the sensor elements!

Re-calibration or exchange of the sensor element are not subject of the general warranty.

*= measuring and documentation of the deviation



» TECHNISCHE DATA

Measuring values	Temperature + relative humidity	
Radio technology	EnOcean (IEC 14543-3-10), transmission power <10 mW (EEP A5-04-01)	
Frequency (type dependent)	868 MHz	902 MHz
Antenna	internal transmitting/receiving antenna	
Power supply	battery operated, 1x Alkali-Mangan AAA (included in delivery) or 1x Lithium 3,6V ER10450	
Measuring range temp	0..+40 °C	
Measuring range humidity	0..100% rH non-condensing	
Accuracy temperature	±0,4 K (typ. at 21 °C)	
Accuracy humidity	±2% between 30..70% rH (typ. at 21 °C)	
Sending interval	At change of temperature $\geq 0,3$ K, or relative humidity $\geq 2\%$ rH; Heartbeat-cycle: random between 14..19 Min	
Enclosure	PC V0, pure white or anthracite (optional)	
Protection	IP20 according to DIN EN 60529	
Ambient condition	0..+40 °C, max. 85% rH non-condensing	
Mounting	to be mounted flat onto the surface using adhesive foil (already mounted on bottom cover) or screws	

» COMISSIONING

Before mounting, the device check the radio signal strength (RSSI) at the receiver position. The radio signal needs to be sufficient for the receiver. The device can be mounted via the adhesive tape already mounted, or optionally with screws

» Device Opening

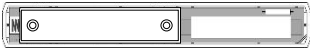
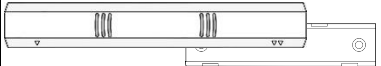
Bottom View	Top View
 <p>Move bottom cover laterally.</p>	 <p>Move device laterally to the left (observe arrow symbol orientation!)</p>
 <p>Remove cover</p>	 <p>Remove top section</p>

» Battery installation

After inserting the battery the device is operative.

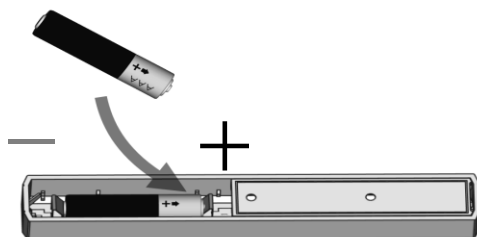

Insert the battery.

Pay attention to battery polarity!

» TEACH-IN

By default, a teach-in telegram is transmitted by pressing the Learn button (opened device). The teach-in telegram identifies the device manufacturer, the function and the type of the device.

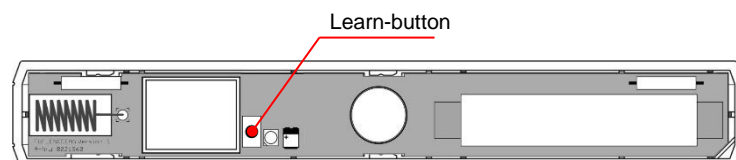

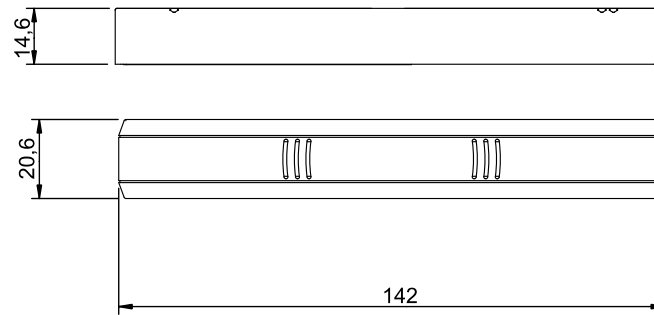
» DIMENSIONS (MM)**» ACCESSORIES**

Battery 1,5V AAA (Micro)
Lithium battery 3,6V AAA (ER10450)

Item No. 739351
Item No. 794756