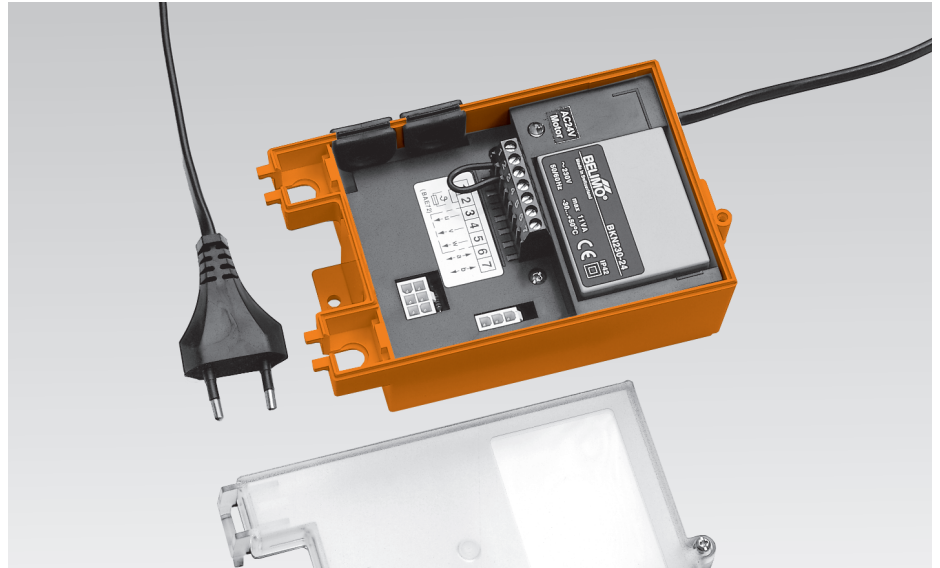

Communication and power supply unit for monitoring of motorized fire and smoke dampers in combination with the communication and control units BKS24-1B oder BKS24-9A

Technical data

Electrical data	Nominal voltage	AC 230 V, 50/60 Hz
	Nominal voltage range	AC 198 ... 264 V
	Power consumption	3.5 W (NORMAL position)
	For wire sizing	11 VA (incl. actuator)
	Connections	Power supply Actuator Screw terminals
Safety	Protection class	II totally insulated <input type="checkbox"/>
	Degree of protection	IP40
	EMC	CE according to 2004/108/EC
	Low voltage directive	CE according to 2006/95/EC
	Ambient temperature	-20° ... +50 °C
	Non-operating temperature	-40° ... +80 °C
	Humidity test	95% r.H., non-condensating (EN 60730-1)
Maintenance	Maintenance-free	
Dimensions / Weight	Dimensions	See «Dimensions» on page 2
	Weight	ca. 550 g

Safety notes

- The device is not allowed to be used outside the specified field of application, especially in aircraft or in any other airborne means of transport.
- It may only be installed by suitably trained personnel. Any legal regulations or regulations issued by authorities must be observed during assembly.
- The device may only be opened at the manufacturer's site. It does not contain any parts that can be replaced or repaired by the user.
- The device contains electrical and electronic components and is not allowed to be disposed of as household refuse. All locally valid regulations and requirements must be observed.

Product features

Mode of operation	The BKN230-24 also functions as a distribution power unit for supplying the BF..24.-ST, BLF24(-T)-ST spring-return actuators that is connected to it. Another of its functions is to signal the NORMAL and SAFE positions of the damper (from the switches in the spring-return actuators) to the central control panel over a 2-wire conductor. The same conductor is used for transmitting the ON/OFF control command from the control panel to the damper actuator via the BKN230-24.
Installation and connections	To simplify installation and connection, the spring-return actuator is fitted with connectors which plug directly into the BKN230-24 unit. The 2-wire conductor is connected to the terminals 6 and 7. The terminals 1 and 2 are for the direct connection of thermal trips or smoke detectors.

Product features

(Continued)

Functional testing

If it is proposed to test the actuator without the BKS24.. unit connected, it can be switched to NORMAL mode by fitting a jumper between terminals 3 and 4.
The green LED in the BKN230-24 unit is bright when power (AC 24 V) is available at the actuator. The SAFE damper position can be checked either by pressing the push-button on the BAE72-S unit or by interrupting the power supply.

Electrical installation

Wiring diagram

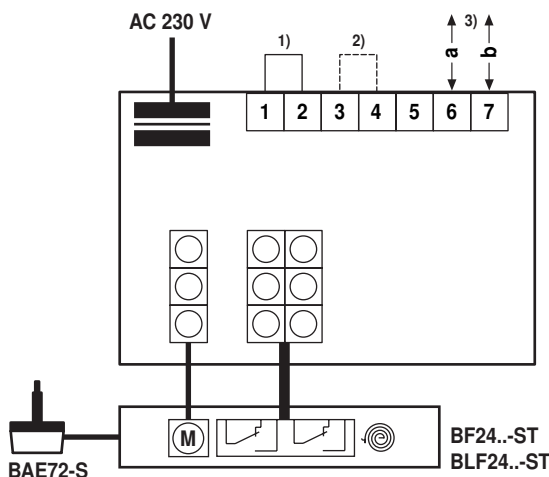

- 1) Jumper factory-fitted. Can be removed if necessary to be replaced by a thermoelectric trip (the safety function will be triggered if terminals 1 and 2 are not linked).
- 2) Jumper only used for commissioning purposes and without BKS24-.. !
- 3) 2-wire conductor to BKS24-..

Dimensions [mm]

Dimensional drawings

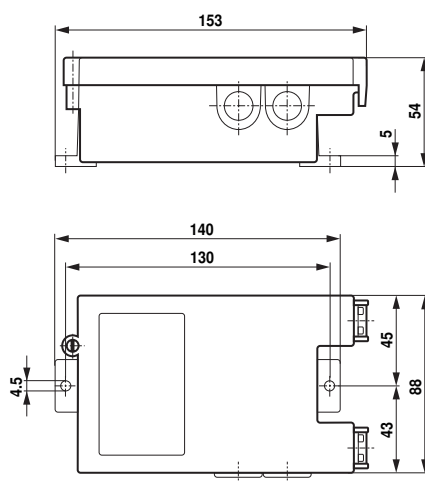

Indications and connections

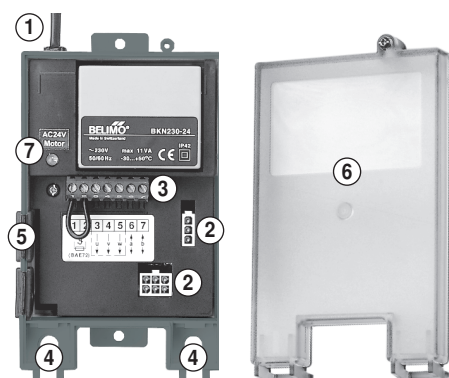

- ① Power supply connection AC 230 V
- ② Plug-in contacts for Belimo actuator 24 V
- ③ Screw terminals 7 poles
- ④ Cable inputs for Belimo actuator
- ⑤ Cable inputs for 2-wire conductor
- ⑥ Transparent protection cover
- ⑦ LED-indication AC 24 V (green)

Schematic diagrams (Exemples)

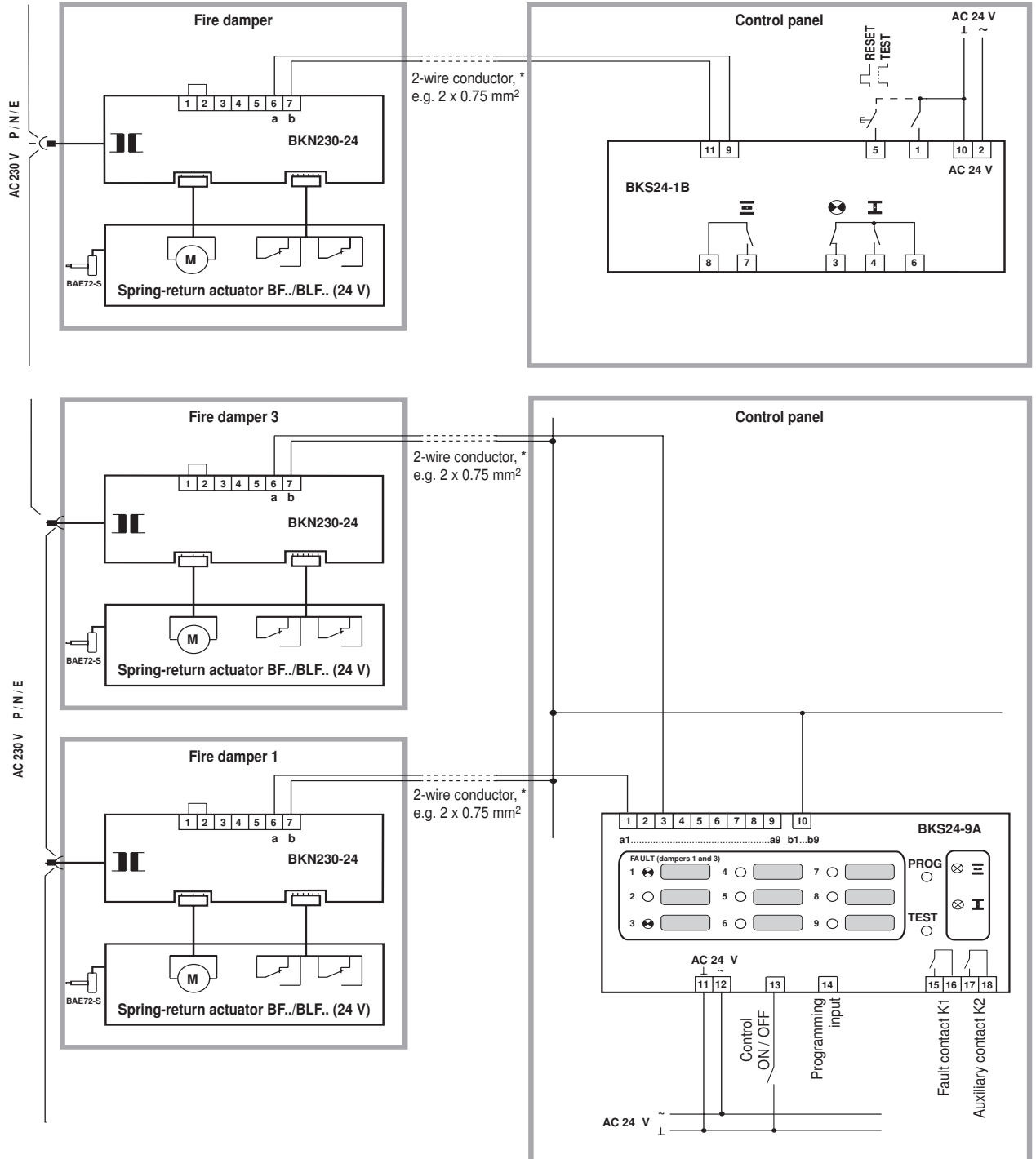

* Lengths of conductors: 2-wire conductors a/b max. 600 m (0.75 m²)