

Compact actuator with damper blade, for the control or isolation of volumetric air flows in air-conditioning plants, particularly where space is limited

- Pipe diameter DN 150
- Torque motor 2 Nm
- Nominal voltage AC 230 V
- Control Open/close, 3-point
- Fit into round air ducts in accordance with DIN EN 1506

Technical data

Electrical data	Nominal voltage	AC 230 V
	Nominal voltage frequency	50/60 Hz
	Nominal voltage range	AC 85...265 V
	Power consumption in operation	1.5 W
	Power consumption in rest position	1 W
	Power consumption for wire sizing	3 VA
	Connection supply / control	Cable 1 m, 3 x 0.75 mm ²
	Parallel operation	Yes (note the performance data)
Functional data	Torque motor	2 Nm
	Pipe diameter	DN 150
	Manual override	with magnet
	Angle of rotation	70°
	Running time motor	58 s / 70°
	Sound power level, motor	35 dB(A)
	Airtightness	Class 2 (DIN EN 1751)
	Resistance coefficient ζ	0.3 (in open position)
Safety	Static differential pressure	Max. 1000 Pa via the damper (4" w.g)
	Flame class	Damper blade UL 94 HB Actuator UL 94 V-0
	Fire behaviour group	Damper blade RF3 (CH) Actuator RF2 (CH)
	Fire load	5.3 MJ
	Protection class IEC/EN	II reinforced insulation
	Protection class UL	II reinforced insulation
	Degree of protection IEC/EN	IP54
	Degree of protection NEMA/UL	NEMA 2
	Enclosure	UL Enclosure Type 2
	EMC	CE according to 2014/30/EU
	Low voltage directive	CE according to 2014/35/EU
	Certification IEC/EN	IEC/EN 60730-1 and IEC/EN 60730-2-14
	Certification UL	cURus according to UL60730-1A, UL60730-2-14 and CAN/CSA E60730-1:02
	Mode of operation	Type 1
	Rated impulse voltage supply / control	2.5 kV
	Control pollution degree	3
	Ambient temperature	-30...50 °C
	Storage temperature	-40...80 °C
	Ambient humidity	Max. 95% r.H., non-condensing
	Servicing	maintenance-free
Weight	Weight	0.34 kg

Safety notes



- The device must not be used outside the specified field of application, especially not in aircraft or in any other airborne means of transport.
- The device must not be used for safety applications, e.g. fire protection.
- As a rule, the device is resistant to a multitude of organic solvents and alkaline agents. Unusual ambient conditions will, however, require special clarifications. In particular, the damper may not be used in environments where it may be exposed to chemically aggressive substances, e.g. laboratory exhaust air or fume hood exhaust air (laboratory exhaust systems / fume hoods).
- Only authorised specialists may carry out installation. All applicable legal or institutional installation regulations must be complied with during installation.
- The CM..D.. (Art. 70949-00001) installation instructions must be observed in order to ensure smooth operation.
- Adherence to the pipe geometry specified in accordance with DIN EN 1506 must be ensured (no damage).
- The device may only be opened at the manufacturer's site. It does not contain any parts that can be replaced or repaired by the user.
- Cables must not be removed from the device.
- The device contains electrical and electronic components and must not be disposed of as household refuse. All locally valid regulations and requirements must be observed.

Product features

Fields of application	<ul style="list-style-type: none"> - Air flow through the building shell - Air distribution / comfort ventilation - Air outlets - Zone controls - Devices with outside air: Facade devices / fan coils / fan-powered boxes / cabin units etc. - Exhaust air systems, e.g. sanitary facilities
Manual override	Manual override with magnet possible (gear disengagement as long as the magnet adheres to the magnet symbol). The Z-MA magnet for the gear disengagement is enclosed.
High functional reliability	The actuator is overload protected, requires no limit switches and automatically stops when the end stop is reached.
Flow noise	The noise caused by the flow of air in the pipe section with a built-in air damper and passed along inside it. Below the sound power levels listed are A-evaluated in the duct as a function of dimension, volumetric flow and pressure loss.

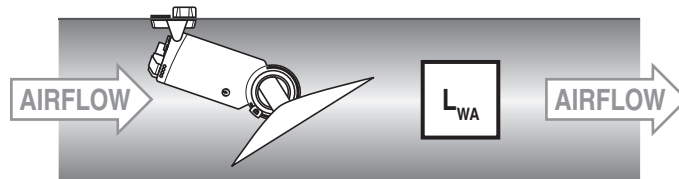

Product features

Sound power level LWA Sound power level with A-evaluation, including correction of the outlet reflection LWA

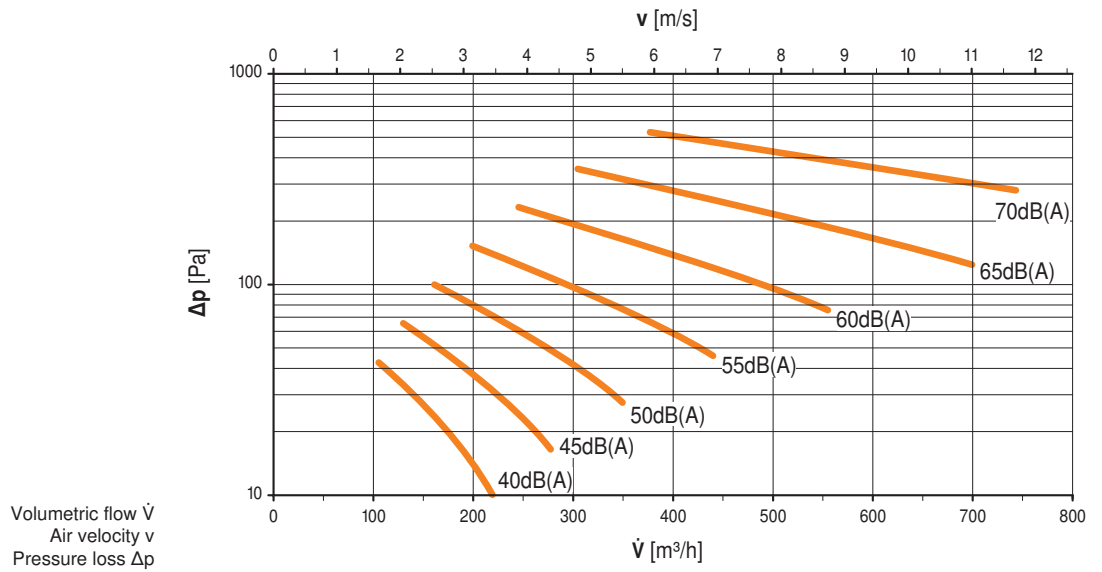

Accessories

	Description	Type
Mechanical accessories	Gear disengagement magnet, Multipack 20 pcs.	Z-MA

Electrical installation

Notes

- Caution: Power supply voltage!
- Parallel connection of other actuators possible. Observe the performance data.

Wiring diagrams

AC 230 V, open/close

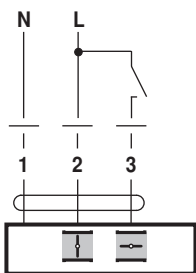

Cable colours:
1 = blue
2 = brown
3 = white

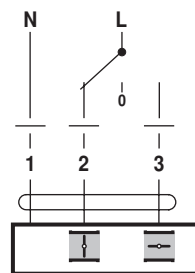

Installation notes

- Pipelines**
- Belimo recommends the use of round folded spiral-seam pipelines (spiro pipes) with 0.5 mm metal gauge (in accordance with DIN EN 1506) and with the fold on the outside of the pipe. Folded spiral-seam pipes are usually rounder than longitudinally-welded pipes. Leakages can be reduced as a result. The interior side of the folded spiral-seam pipes is smooth. The welding seam can inhibit the function of the damper blade with longitudinally welded pipes. If longitudinally welded pipes nevertheless need to be used, Belimo cannot guarantee the proper functioning of the actuator.
 - No protruding longitudinal fold facing inward permitted
 - Use only galvanised sheet steel or chrome steel. Installation in plastic pipelines is not recommended.
 - Do not place the fastening holes of the actuator across from the welding seam. The damper blade could become damaged after a short time. The fastening holes should be drilled approximately 40 mm away from the welding seam. This will reduce the damper noise and damage to the damper blade to a minimum.

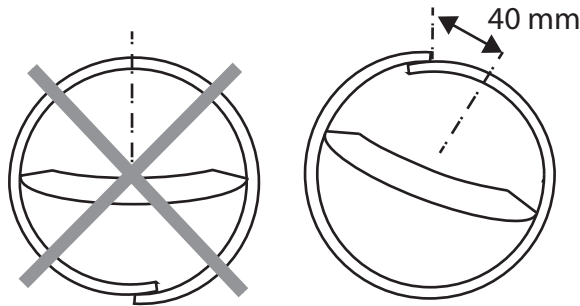

Installation situation For the pipe connection, take into account the pipe collar size (insertion depth L1) before the actuator fixing and after the damper blade.

Observe correct direction of air flow: → Actuator → Damper blade →
Special installation shapes require verification.

The strain relief of the cable is guaranteed in the CM.. actuator.

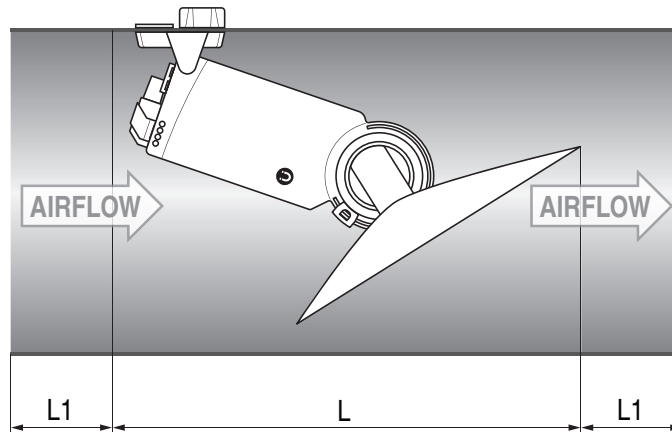

It requires the following alignment of the bore holes

