

Damper actuator for adjusting dampers in technical building installations

- Air damper size up to approx. 0.4 m²
- Torque motor 2 Nm
- Nominal voltage AC 100...240 V
- Control Open/close, 3-point

Technical data

| | | |
|--|------------------------------------|---|
| Electrical data | Nominal voltage | AC 100...240 V |
| | Nominal voltage frequency | 50/60 Hz |
| | Nominal voltage range | AC 85...264 V |
| | Power consumption in operation | 1.5 W |
| | Power consumption in rest position | 1 W |
| | Power consumption for wire sizing | 3 VA |
| | Connection supply / control | Cable 1 m, 3 x 0.75 mm ² |
| | Parallel operation | Yes (note the performance data) |
| Functional data | Torque motor | 2 Nm |
| | Direction of motion motor | clockwise rotation |
| | Manual override | with magnet |
| | Angle of rotation | 0...287.5°, |
| | Angle of rotation note | Without limitation: endless 315° with one end stop clip mounted on the actuator |
| | Running time motor | 75 s / 90° |
| | Sound power level, motor | 35 dB(A) |
| | Mechanical interface | Universal shaft clamp 6...12.7 mm |
| | Position indication | Mechanically, pluggable (with integrated magnet for gear disengagement) |
| | Safety data | Protection class IEC/EN |
| Protection class UL | | II reinforced insulation |
| Degree of protection IEC/EN | | IP54 |
| Degree of protection NEMA/UL | | NEMA 2 UL Enclosure Type 2 |
| EMC | | CE according to 2014/30/EU |
| Low voltage directive | | CE according to 2014/35/EU |
| Certification IEC/EN | | IEC/EN 60730-1 and IEC/EN 60730-2-14 |
| Certification UL | | cULus according to UL60730-1A, UL60730-2-14 and CAN/CSA E60730-1:02 The UL marking on the actuator depends on the production site, the device is UL-compliant in any case |
| Mode of operation | | Type 1 |
| Rated impulse voltage supply / control | | 2.5 kV |
| Control pollution degree | | 3 |
| Ambient temperature | | -30...50°C |
| Storage temperature | | -40...80°C |
| Ambient humidity | | Max. 95% r.H., non-condensing |
| Servicing | | maintenance-free |
| Weight | Weight | 0.24 kg |

Safety notes



- The device must not be used outside the specified field of application, especially not in aircraft or in any other airborne means of transport.
- Outdoor application: only possible in case that no (sea) water, snow, ice, insulation or aggressive gases interfere directly with the device and that it is ensured that the ambient conditions remain within the thresholds according to the data sheet at any time.
- Caution: Power supply voltage!
- Only authorised specialists may carry out installation. All applicable legal or institutional installation regulations must be complied during installation.
- The device may only be opened at the manufacturer's site. It does not contain any parts that can be replaced or repaired by the user.
- Cables must not be removed from the device.
- To calculate the torque required, the specifications supplied by the damper manufacturers concerning the cross-section, the design, the installation site and the ventilation conditions must be observed.
- The device contains electrical and electronic components and must not be disposed of as household refuse. All locally valid regulations and requirements must be observed.

Product features

| | |
|-------------------------------------|---|
| Simple direct mounting | The actuator is mounted directly on the damper shaft (Ø 6...12.7 mm) with a universal shaft clamp and then secured with the anti-rotation clip, to prevent it from rotating. The anti-rotation clip Z-ARCM is included in the scope of delivery. |
| Manual override | Manual override with magnet possible (the gear is disengaged as long as the magnet adheres to the magnet symbol). The magnet for gear disengagement is integrated in the position indication. |
| Adjustable angle of rotation | Adjustable angle of rotation with mechanical end stops. |
| High functional reliability | The actuator is overload protected, requires no limit switches and automatically stops when the end stop is reached. |

Accessories

| Mechanical accessories | Description | Type |
|------------------------|--|--------|
| | Shaft extension 170 mm Ø10 mm for damper shaft Ø 6...16 mm | AV6-20 |
| | Anti-rotation clip, Multipack 20 pcs. | Z-ARCM |
| | End stop clip, Multipack 20 pcs. | Z-ESCM |
| | Gear disengagement magnet, Multipack 20 pcs. | Z-MA |
| | Position indicator, Multipack 20 pcs. | Z-PICM |

Electrical installation

Caution: Power supply voltage!
Parallel connection of other actuators possible. Observe the performance data.
Wiring diagrams

AC 230 V, open/close

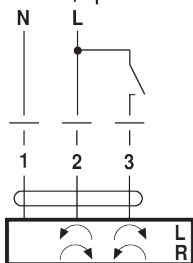
Cable colours:

- 1 = blue
- 2 = brown
- 3 = white

AC 230 V, 3-point

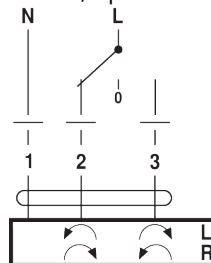
Cable colours:



- 1 = blue
- 2 = brown
- 3 = white

Dimensions

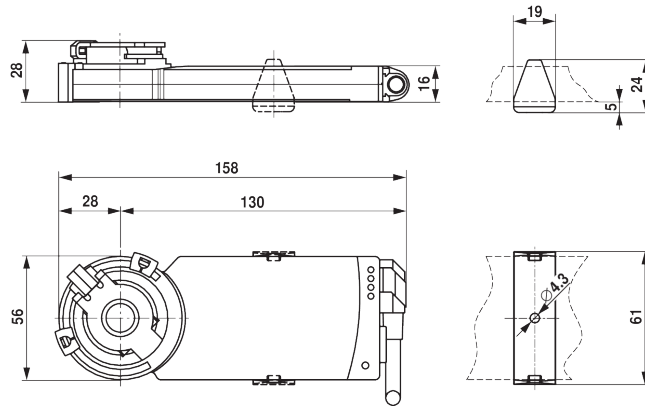
Dimensional drawings



Clamping range

| | | |
|---|---|---|
|  |  |  |
| 6...12.7 | 6 / 8 / 10 | 6...12.7 |

Shaft length

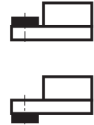
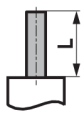

Min. 32