

- Air damper size up to approx. 0.4 m²
- Torque motor 2 Nm
- Nominal voltage AC/DC 24 V
- Control communicative
- Communication via Belimo MP-Bus



Technical data

Electrical data	Nominal voltage	AC/DC 24 V
	Nominal voltage frequency	50/60 Hz
	Nominal voltage range	AC 19.2...28.8 V / DC 19.2...28.8 V
	Power consumption in operation	1 W
	Power consumption in rest position	0.5 W
	Power consumption for wire sizing	1.5 VA
	Connection supply / control	Cable 1 m, 3 x 0.75 mm ²
	Parallel operation	Yes (note the performance data)
Functional data	Torque motor	2 Nm
	Communicative control	MP-Bus
	Direction of motion motor	counter-clockwise rotation
	Direction of motion note	0%: left end stop, position 0
	Manual override	with magnet
	Angle of rotation	0...287.5°
	Running time motor	75 s / 90°
	Adaptation setting range	manual with magnet (automatic on first power-up)
	Sound power level, motor	35 dB(A)
	Mechanical interface	Universal shaft clamp 6...12.7 mm
	Position indication	Mechanically, pluggable (with integrated magnet for gear disengagement)
	Safety data	Protection class IEC/EN
Protection class UL		UL Class 2 Supply
Degree of protection IEC/EN		IP54
Degree of protection NEMA/UL		NEMA 2 UL Enclosure Type 2
EMC		CE according to 2014/30/EU
Certification IEC/EN		IEC/EN 60730-1 and IEC/EN 60730-2-14
Certification UL		cULus according to UL60730-1A, UL60730-2-14 and CAN/CSA E60730-1:02 The UL marking on the actuator depends on the production site, the device is UL-compliant in any case
Mode of operation		Type 1
Rated impulse voltage supply / control		0.8 kV
Control pollution degree		3
Ambient temperature		-30...50°C
Storage temperature		-40...80°C
Ambient humidity		Max. 95% r.H., non-condensing
Servicing		maintenance-free
Weight		Weight

Safety notes



- The device must not be used outside the specified field of application, especially not in aircraft or in any other airborne means of transport.
- Outdoor application: only possible in case that no (sea) water, snow, ice, insulation or aggressive gases interfere directly with the device and that it is ensured that the ambient conditions remain within the thresholds according to the data sheet at any time.
- Only authorised specialists may carry out installation. All applicable legal or institutional installation regulations must be complied during installation.
- The device may only be opened at the manufacturer's site. It does not contain any parts that can be replaced or repaired by the user.
- Cables must not be removed from the device.
- The device contains electrical and electronic components and must not be disposed of as household refuse. All locally valid regulations and requirements must be observed.

Product features

Mode of operation	<p>The actuator receives its digital positioning signal from the higher level controller via the MP-Bus and drives to the position defined. Connection U serves as communication interface and does not supply an analogue measuring voltage.</p> <p>Note: Neither a conventional operation with a standard signal nor a parametrisation of signals (e.g. running time) is possible. With the parametrisation devices a functional check can be executed and the MP address can be assigned.</p>
Simple direct mounting	<p>The actuator is mounted directly on the damper shaft (Ø 6...12.7 mm) with a universal shaft clamp and then secured with the anti-rotation clip, to prevent it from rotating.</p> <p>The anti-rotation clip Z-ARCM is included in the scope of delivery.</p>
Manual override	<p>Manual override with magnet possible (the gear is disengaged as long as the magnet adheres to the magnet symbol). The magnet for gear disengagement is integrated in the position indication.</p> <p>After a manual override, it is mandatory that an adaption via magnet be triggered at the position intended for this purpose.</p>
Adjustable angle of rotation	Adjustable angle of rotation with mechanical end stops.
High functional reliability	The actuator is overload protected, requires no limit switches and automatically stops when the end stop is reached.
Home position	<p>The first time the supply voltage is switched on, i.e. at the time of commissioning, the actuator carries out an adaption, which is when the operating range and position feedback adjust themselves to the mechanical setting range.</p> <p>The actuator then moves into the position defined by the positioning signal.</p>
Adaptation and synchronisation	<p>An adaption can be triggered manually through activation of the magnet switch or with the PC-Tool. Both mechanical end stops are detected during the adaption (entire setting range).</p> <p>The actuator then moves into the position defined by the positioning signal.</p>
Hidden synchronisation	If the actuator drives to the lower end stop during ongoing operation, then it performs a synchronisation.

Accessories

Gateways	Description	Type
	Gateway MP zu BACnet MS/TP	UK24BAC
	Gateway MP to Modbus RTU	UK24MOD
Electrical accessories	Description	Type
	Connection cable 5 m, A: RJ11 6/4 ZTH EU, B: free wire end for connection to MP/PP terminal	ZK2-GEN
	MP-Bus power supply for MP actuators	ZN230-24MP
Service tools	Description	Type
	Adapter for Service-Tool ZTH	MFT-C
	Belimo PC-Tool, Software for adjustments and diagnostics	MFT-P
	Service Tool, with ZIP-USB function, for parametrisable and communicative Belimo actuators, VAV controller and HVAC performance devices	ZTH EU

Electrical installation



Supply from isolating transformer.

Parallel connection of other actuators possible. Observe the performance data.

Wiring diagrams

AC/DC 24 V, MPL

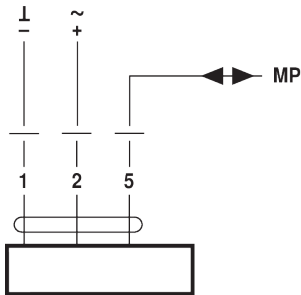

Cable colours:

1 = black

2 = red

5 = orange

Functions

Functions when operated on MP-Bus

Connection on the MP-Bus

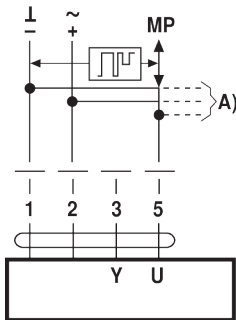

A) additional MP-Bus nodes (max. 8)

MP-Bus Network topology

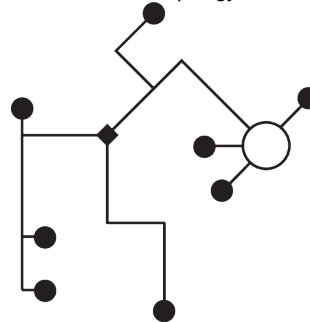

There are no restrictions for the network topology (star, ring, tree or mixed forms are permitted).

Supply and communication in one and the same 3-wire cable

- no shielding or twisting necessary
- no terminating resistors required

Operating controls and indicators

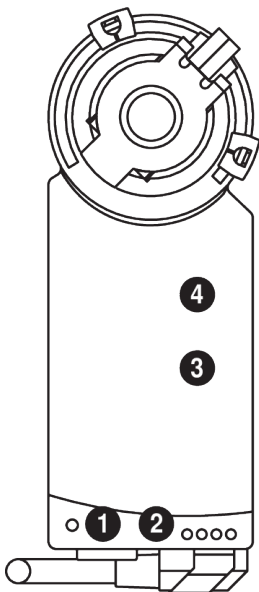

1 LED display yellow

On: Angle of rotation adaptation active

2 LED display green

Off: No supply or no MP-Bus level

On: Power supply and MP-Bus level OK, no MP communication

Flickering: MP communication active

Flashing: Depiction of MP address (Command from MP master)

3 Magnet switch

Magnetized: Triggering the angle of rotation adaptation

4 Magnet disengagement

Magnetized: Gear disengages, manual override possible

Service

Service Tools connection The actuator can be parametrised by ZTH EU via terminal connection. For extended parametrisation the PC tool can be connected.

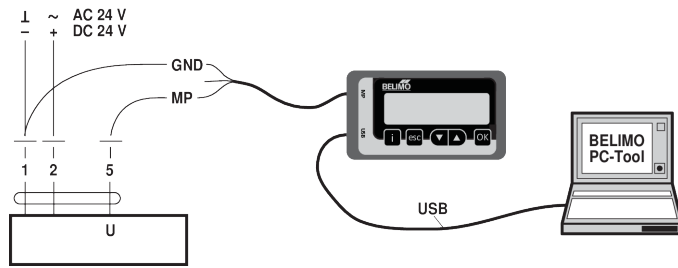

Dimensions

Dimensional drawings

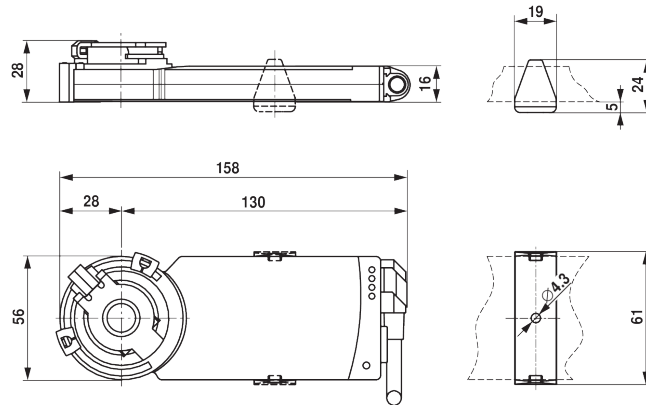

Clamping range

6...12.7	6 / 8 / 10	6...12.7

Shaft length

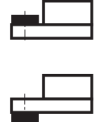
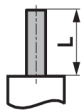

Min. 32

Further documentation

- Overview MP Cooperation Partners
- Tool connections
- Introduction to MP-Bus Technology

Application notes

- For digital control of actuators in VAV applications patent EP 3163399 must be considered.