

MINI MOTORIZED VALVE



CREATIVE • INNOVATION • PROCESS



Features

CONVALVE AC/DC motorized ball valve consists of on/off type or 3-point type actuator and CBBVM/CSBVM series ball valves, which have compact structure, stable operation, excellent capacity of water stoppage, large water flow rate, zero dirt block and low torque.

CONVALVE motorized ball valves are widely used in HVAC system, heating system, water treatment system and some industrial applications.

Operation Mode

Convalve motorized ball valve is motor-operated by a type of EA7220A, EA7220AM, EA7024D and EA7024DM actuator. The actuator is controlled by a modulating on/off or 3-point control system and move the ball of the valve, to the opening position detected by the control signal.

Advantage

- Low resistance with the medium
- Light weight and small volume components, which is easy for installation and transportation
- Healthful and non-toxic: the product belongs to environmental green protective building materials. It can be used in the piping system of pure water and drinking water
- High temperature resistance: the maximum sustained working temperature is up to 70°C, the maximum transient temperature is up to 95°
- Higher flow capacity: smooth interior walls result in lower pressure loss and higher volume than metal pipes
- Attractive appearance and professional design
- Competitive prices
- Long service life: more than 50 years under normal condition
- 100% leakage testing, ensuring the tightness



Application

- Potable water pipe networks for cold and warm water installations of residential
- Buildings, hospitals, hotels, schools, office buildings and shipbuilding
- Pipe networks for rainwater utilization systems
- Pipe networks for compressed air plants
- Pipe networks for swimming pool facilities
- Pipe networks for solar plants
- Pipe networks in agriculture and horticulture
- Heating pipes for residential housing
- Pipe networks for industry, i.e. transport of aggressive fluids (acid, alkali)
- Transport of liquid foods

Technical Data Valve

Valve Body:

- Medium: cold/hot water, air, gases
- Temperature of medium: 2° C...90° C (Max. 120° C for SS304)
- Rated pressure: PN20
- Pipe connector: BSP internal thread
- Ambient temp. range: -5...+60° C; 0...90%RH
- Size: 1/2", 3/4" and 1"
- Valve type: 2-way and 3-way

Material:

- Valve body: forged brass, 2.0381
 - Sealing: EPDM+PTFE, with double O-ring
 - Ball: nickel-plated brass
 - Stem: EPDM O-rings, with double O-ring
-
- Valve body: Stainless Steel SS304, 1.4308
 - Sealing: EPDM+PTFE, with double O-ring
 - Ball: Stainless Steel SS304
 - Stem: EPDM O-rings, with double O-ring

Stainless Dimension

Model No.		Inner Dia.	Inch	Kvs(m ³ /h)	ΔPmax(bar)	ΔPs(bar)
CSBVM215	2-way	15mm	1/2"	8.97	10	14
CSBVM220		20mm	3/4"	15.94	10	14
CSBVM225		25mm	1"	24.85	10	14
CSBVM315	3-way	15mm	1/2"	8.97	10	14
CSBVM320		20mm	3/4"	15.94	10	14
CSBVM325		25mm	1"	24.85	10	14

Brass Dimension

Model No.		Inner Dia.	Inch	Kvs(m ³ /h)	ΔPmax(bar)	ΔPs(bar)
CBBVM215	2-way	12mm	1/2"	6.15	10	14
CBBVM220		15mm	3/4"	10.50	10	14
CBBVM225		20mm	1"	16.10	10	14
CBBVM315	3-way	10mm	1/2"	3.95	10	14
CBBVM320		15mm	3/4"	6.80	10	14
CBBVM325		18mm	1"	15.80	10	14



Technical Data Actuator 220AC

Actuator:

EA7.....AM	AC230/110/24V, 50/60Hz, 3-point
EA7.....A	AC230/110/24V, 50/60Hz, on/off
Output torque : >3.5N.m	Angle of rotation: 90°
Protection rating: IP55/IP54	On/off time: 16 sn. (50Hz)

Function (3-point or on/off type)

- The actuator is controlled by a modulating on/off or 3-point control signal, using reversible synchronous motor and gear speed reducer drive to fix and lock.

EA7.....AM 3-point type

- Black wire is power on.....Valve closed
- Brown wire is power onValve open
- Black or brown wire is power off.....Valve keep the current position
- Blue wire is connected to the null wire.....Also can be used as on/off type.

EA7.....A on/off type

- Black wire is the control wire.....Power on: valve open, power off: valve close
- Brown wire is connected to the power wire.
- Blue wire is connected to the com.Only can be used as on/off type.

Model No.	Working Voltage	Actuator type	Output torque	Consumption	On/off time	Valve body
EA7220AM	230VAC±15%	3-point or on/off	3.5N.m	7W	50Hz:16 sn 60Hz:12 sn	CBBVM215
EA7220A	50/60Hz	On/off				CBBVM220
EA7110AM	110VAC±15%	3-point or on/off				CBBVM225
EA7110A	50/60Hz	On/off				CBBVM315
EA7024AM	24VAC±15%	3-point or on/off				CBBVM320
EA7024A	50/60Hz	On/off				CBBVM325

Installation:

Insert the valve stem to the bottom of the actuator, and insert 2 pin, located in the bottom of the actuator to the valve's mounting hole. Then screw down the brass cap nut.

Wiring

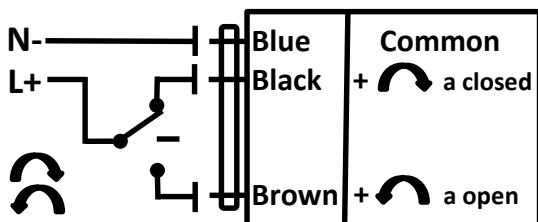

Valve (ON) : Brown wire
 Valve (OFF) : Black wire
 Com(N) : Blue wire

Black wire and brown wire are prohibited to get electricity at the same time!
EA7024AM, EA7110AM, EA7220AM

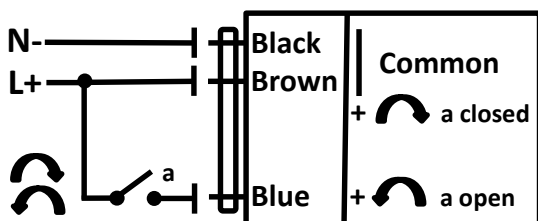

Control wire : Black wire
 Power wire(L) : Brown wire
 Common port(N) : Blue wire

EA7024A, EA7110A, EA7220A

Technical Data Actuator 24DC

Actuator:

EA7.....M	DC3/6-12/24V, 3-point
EA7.....D	DC3/6-12/24V, on/off
Output torque : 2,5 N.m	Angle of rotation : 90°
Protection rating: IP55/IP54	On/off time : 2-12 sec.

Function (3-point or on/off type)

- The actuator is controlled by a modulating on/off or 3-point control signal, using reversible synchronous motor and gear speed reducer drive to fix and lock.

EA7.....DM 3-point type

- Brown wire is power on.....Valve open
- Black wire is power onValve close
- Brown or black wire is power off.....Valve keep the current position
- Blue wire is connected to the null wire..... Also can be used as on/off type.

EA7.....D on/off type

- Blue wire is the control wire.....Power on: valve open, power off: valve close
- Black wire is connected to the com.
- Brown wire is connected to the power wire.
- Only can be used as on/off type.

Model No.	Working Voltage		Actuator Type	Output Torque	Consumption	On/off time	Valve Body
EA7003DM	DC3V		3-point or on/off	2,5N.m	3W	2-12 sec	CBBVM215
EA7003D			On/off				CBBVM220
EA7012DM	DC12V		3-point or on/off				CBBVM225
EA7012D			On/off				CBBVM315
EA7024DM	DC24V		3-point or on/off				CBBVM320
EA7024D			On/off				CBBVM325

Installation:

Insert the valve stem to the bottom of the actuator, and insert 2 pin, located in the bottom of the actuator to the valve's mounting hole. Then screw down the brass cap nut.

Wiring

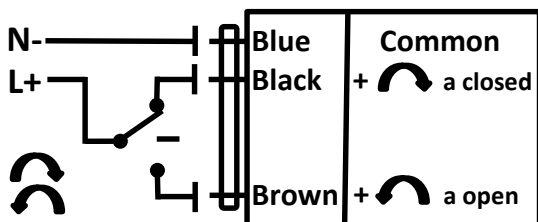

Valve (ON) : BROWN wire
 Valve (OFF) : BLACK wire
 Com(N) : BLUE wire

Black wire and brown wire are prohibited to get electricity at the same time!
EA7003DM, EA7012DM, EA7024DM

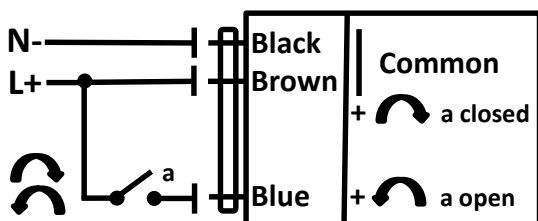

On-Off wire : BLUE wire
 Power wire : BROWN wire
 Com(N) : BLACK wire

EA7003D, EA7012D, EA7024D

Valve Structure: 2 Way Stainless / Brass

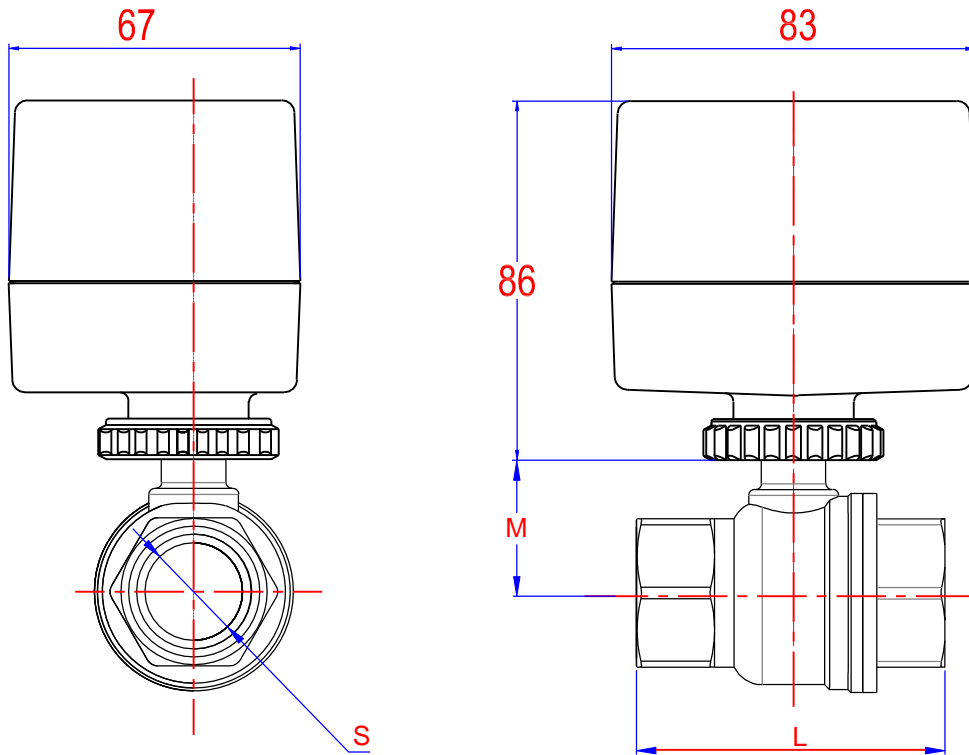

Stainless Valve			
	DN15	DN20	DN25
S (mm)	15	20	25
M (mm)	31	34	38
L (mm)	57	65	79

Brass Valve			
	DN15	DN20	DN25
S (mm)	12	15	20
M (mm)	23	26	32
L (mm)	51	58	73

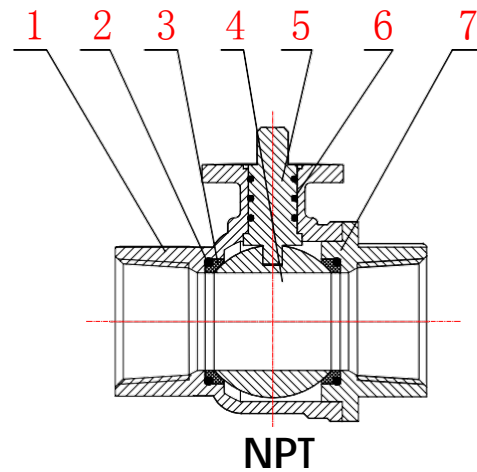
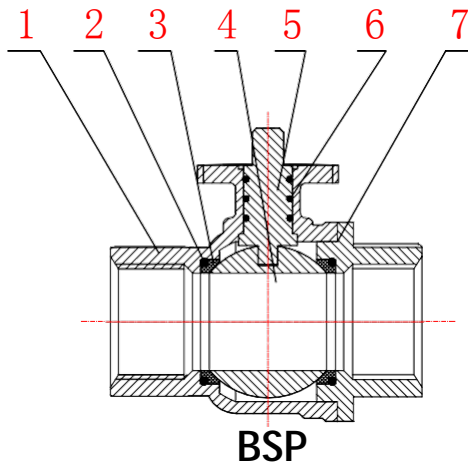

Part No.	1	2	3	4	5	6	7
Name	Main Body Female Part	O-ring	Sealing Ring	Ball Core	Valve Stem	O-ring	Main Body Male Part
QTY	1	2	2	1	1	3	1

Valve Structure: 3 Way Stainless / Brass

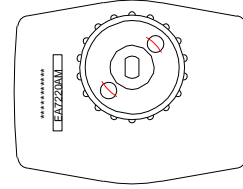
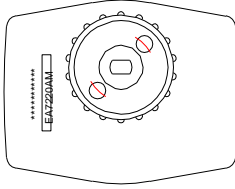

Actuator state as delivered

Installation method 1:

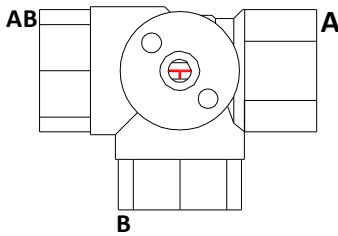

EA7024A/EA7110A/EA7220A:
The power is supplied to the Black wire and the Brown wire, valves will be opened.

EA7003DM/EA7012DM/EA7024DM:
The power is supplied to the Brown wire, valves will be opened.

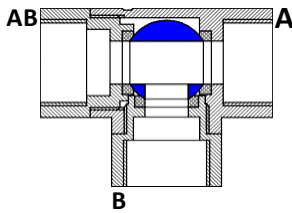

90 degrees counter clockwise turn

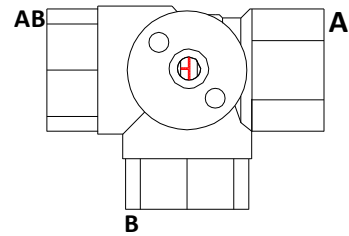

EA7024A/EA7110A/EA7220A:
The power is supplied to the Brown wire valves will be closed.

EA7003DM/EA7012DM/EA7024DM:
The power is supplied to the Blue wire valves will be closed.

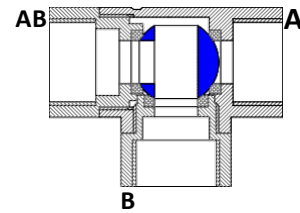

90 degrees clockwise turn

EA7220AM(A)+CBBVM315/20/25. at 90 degrees clockwise and counterclockwise turn. Core Ball is "T" mode.

Installation method 2:

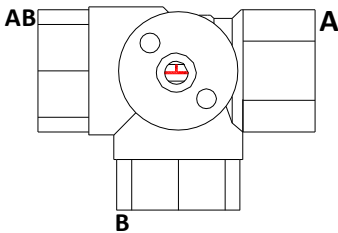

EA7024A/EA7110A/EA7220A:
The power is supplied to the Black wire and the Brown wire, valves will be opened.

EA7003DM/EA7012DM/EA7024DM:
The power is supplied to the Brown wire, valves will be opened.

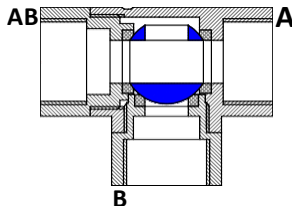

90 degrees counter clockwise turn

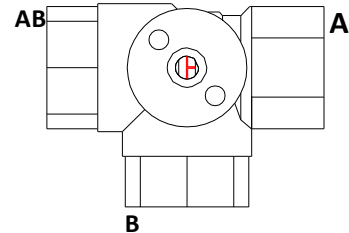

EA7024A/EA7110A/EA7220A:
The power is supplied to the Brown wire valves will be closed.

EA7003DM/EA7012DM/EA7024DM:
The power is supplied to the Blue wire valves will be closed.

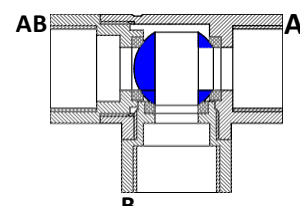

90 degrees clockwise turn

EA7220AM(A)+CBBVM315/20/25. at 90 degrees clockwise and counterclockwise turn. Core Ball is "T" mode

Valve Structure: 3 Way Stainless / Brass

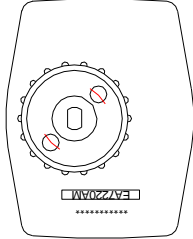

Actuator state as delivered

Installation method 1:

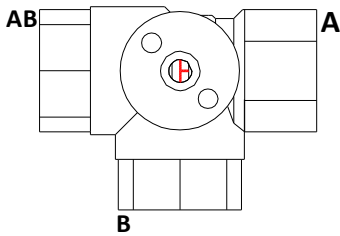

EA7024A/EA7110A/EA7220A:
The power is supplied to the Black wire and the Brown wire, valves will be opened.

EA7003DM/EA7012DM/EA7024DM:
The power is supplied to the Brown wire, valves will be opened.

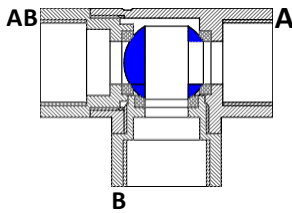

90 degrees counter clockwise turn



90 degrees clockwise turn

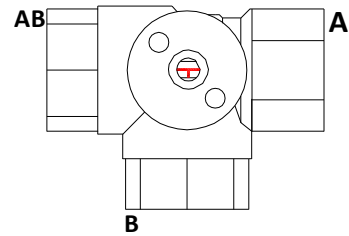
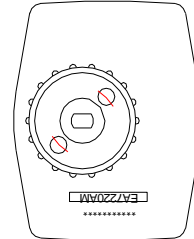

EA7024A/EA7110A/EA7220A:
The power is supplied to the Brown wire valves will be closed.

EA7003DM/EA7012DM/EA7024DM:
The power is supplied to the Blue wire valves will be closed.

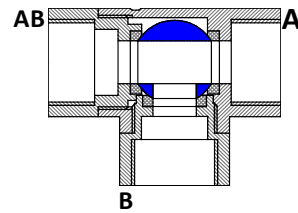

EA7220AM(A)+CBBVM315/20/25. at 90 degrees clockwise and counterclockwise turn. Core Ball is "T" mode.

Installation method 2:

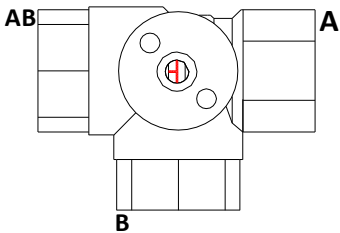

EA7024A/EA7110A/EA7220A:
The power is supplied to the Black wire and the Brown wire, valves will be opened.

EA7003DM/EA7012DM/EA7024DM:
The power is supplied to the Brown wire, valves will be opened.

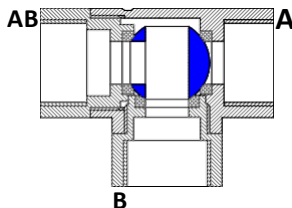

90 degrees counter clockwise turn



90 degrees clockwise turn

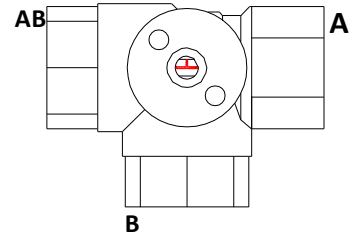

EA7024A/EA7110A/EA7220A:
The power is supplied to the Brown wire valves will be closed.

EA7003DM/EA7012DM/EA7024DM:
The power is supplied to the Blue wire valves will be closed.

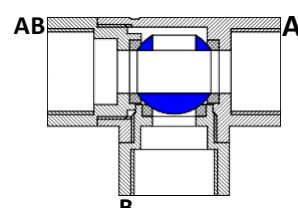

EA7220AM(A)+CBBVM315/20/25. at 90 degrees clockwise and counterclockwise turn. Core Ball is "T" mode