

Communicative globe valve actuator for 2-way and 3-way globe valves

- Actuating force 2500 N
- Nominal voltage AC/DC 24 V
- Control modulating, communicative, hybrid
- Stroke 40 mm
- Conversion of sensor signals
- Communication via BACnet MS/TP, Modbus RTU, Belimo-MP-Bus or conventional control

Technical data

Electrical data	Nominal voltage	AC/DC 24 V
	Nominal voltage frequency	50/60 Hz
	Nominal voltage range	AC 19.2...28.8 V / DC 21.6...28.8 V
	Power consumption in operation	4 W
	Power consumption in rest position	1.5 W
	Power consumption for wire sizing	6 VA
	Connection supply / control	Cable 1 m, 6 x 0.75 mm ²
Functional data	Actuating force motor	2500 N
	Communicative control	BACnet MS/TP Modbus RTU (ex works) MP-Bus
	Operating range Y	2...10 V
	Operating range Y variable	0.5...10 V
	Position feedback U	2...10 V
	Position feedback U note	Max. 0.5 mA
	Position feedback U variable	Start point 0.5...8 V End point 2...10 V
	Position accuracy	±5%
	Manual override	with push-button, can be locked
	Stroke	40 mm
	Running time motor	150 s / 40 mm
	Running time motor variable	90...150 s
	Adaptation setting range	manual (automatic on first power-up)
	Adaptation setting range variable	No action Adaptation when switched on Adaptation after pushing the gear disengagement button
	Override control, controllable via bus communication	MAX (maximum position) = 100% MIN (minimum position) = 0% ZS (intermediate position) = 50%
Override control variable	MAX = (MIN + 33%)...100% MIN = 0%...(MAX - 33%) ZS = MIN...MAX	
Sound power level, motor	56 dB(A)	
Position indication	Mechanically, 5...40 mm stroke	
Safety	Protection class IEC/EN	III Safety Extra-Low Voltage (SELV)
	Protection class UL	UL Class 2 Supply
	Degree of protection IEC/EN	IP54
	Degree of protection NEMA/UL	NEMA 2
	Enclosure	UL Enclosure Type 2
	EMC	CE according to 2014/30/EU
	Certification IEC/EN	IEC/EN 60730-1 and IEC/EN 60730-2-14
	Certification UL	cULus according to UL60730-1A, UL60730-2-14 and CAN/CSA E60730-1:02
	Certification UL note	The UL marking on the actuator depends on the production site, the device is UL-compliant in any case
	Mode of operation	Type 1
Rated impulse voltage supply / control	0.8 kV	

Technical data

Safety	Control pollution degree	3
	Ambient temperature	0...50 °C
	Storage temperature	-40...80 °C
	Ambient humidity	Max. 95% r.H., non-condensing
	Servicing	maintenance-free
Weight	Weight	3.6 kg

Safety notes



- This device has been designed for use in stationary heating, ventilation and air-conditioning systems and must not be used outside the specified field of application, especially in aircraft or in any other airborne means of transport.
- Outdoor application: only possible in case that no (sea) water, snow, ice, insolation or aggressive gases interfere directly with the actuator and that is ensured that the ambient conditions remain at any time within the thresholds according to the data sheet.
- Only authorised specialists may carry out installation. All applicable legal or institutional installation regulations must be complied during installation.
- The switch for changing the direction of motion and so the closing point may be adjusted only by authorised specialists. The direction of motion is critical, particularly in connection with frost protection circuits.
- The device may only be opened at the manufacturer's site. It does not contain any parts that can be replaced or repaired by the user.
- Cables must not be removed from the device.
- The device contains electrical and electronic components and must not be disposed of as household refuse. All locally valid regulations and requirements must be observed.

Product features

Mode of operation	The actuator is fitted with an integrated interface for BACnet MS/TP, Modbus RTU and MP-Bus. It receives the digital positioning signal from the control system and returns the current status.
Converter for sensors	Connection option for a sensor (passive, active or with switching contact). In this way, the analogue sensor signal can be easily digitised and transferred to the bus systems : BACnet, Modbus or MP-Bus.
Parametrisable actuators	The factory settings cover the most common applications. Single parameters can be modified with the Belimo Service Tools MFT-P or ZTH EU. The communication parameters of the bus systems (address, baud rate etc.) are set with the ZTH EU. Pressing the "Address" button on the actuator while connecting the supply voltage, resets the communication parameters to the factory setting. Quick addressing: The BACnet and Modbus address can alternatively be set using the buttons on the actuator and selecting 1...16. The value selected is added to the «Basic address» parameter and results in the effective BACnet and Modbus address.
Combination analogue - communicative (hybrid mode)	With conventional control by means of an analogue positioning signal, BACnet or Modbus can be used for the communicative position feedback
Simple direct mounting	Simple direct mounting on the globe valve by means of form-fit hollow clamping jaws. The actuator can be rotated by 360° on the valve neck.
Manual override	Manual override with push-button possible (the gear is disengaged for as long as the button is pressed or remains locked). The stroke can be adjusted by using a hexagon socket screw key (5 mm), which is inserted into the top of the actuator. The stroke shaft extends when the key is rotated clockwise.
High functional reliability	The actuator is overload protected, requires no limit switches and automatically stops when the end stop is reached.
Combination valve/actuator	Refer to the valve documentation for suitable valves, their permitted fluid temperatures and closing pressures.

Product features

Position indication	The stroke is indicated mechanically on the bracket with tabs. The stroke range adjusts itself automatically during operation.
Home position	<p>Factory setting: Actuator spindle is retracted.</p> <p>When valve-actuator combinations are shipped, the direction of motion is set in accordance with the closing point of the valve.</p> <p>The first time the supply voltage is switched on, i.e. at the time of commissioning, the actuator carries out an adaption, which is when the operating range and position feedback adjust themselves to the mechanical setting range.</p> <p>The actuator then moves into the position defined by the positioning signal.</p>
Setting direction of stroke	When actuated, the stroke direction switch changes the running direction in normal operation.
Adaption and synchronisation	<p>An adaption can be triggered manually by pressing the "Adaption" button or with the PC-Tool. Both mechanical end stops are detected during the adaption (entire setting range).</p> <p>Automatic synchronisation after pressing the gearbox disengagement button is configured. The synchronisation is in the home position (0%).</p> <p>The actuator then moves into the position defined by the positioning signal.</p> <p>A range of settings can be adapted using the PC-Tool (see MFT-P documentation)</p>

Accessories

	Description	Type
Electrical accessories	Connection cable 5 m, A: RJ11 6/4 ZTH EU, B: 6-pin for connection to service socket	ZK1-GEN
	Connection cable 5 m, A: RJ11 6/4 ZTH EU, B: free wire end for connection to MP/PP terminal	ZK2-GEN
Service Tools	Description	Type
	Service Tool, with ZIP-USB function, for parametrisable and communicative Belimo actuators / VAV controller and HVAC performance devices	ZTH EU
	Belimo PC-Tool, Software for adjustments and diagnostics	MFT-P
	Adapter for Service-Tool ZTH	MFT-C

Electrical installation



Notes

- Connection via safety isolating transformer.
- Direction of stroke switch factory setting: Actuator spindle retracted (▲).
- The wiring of the line for BACnet MS/TP / Modbus RTU is to be carried out in accordance with applicable RS485 regulations.
- Modbus / BACnet: Supply and communication are not galvanically isolated. Connect earth signal of the devices with one another.

Wiring diagrams

BACnet MS/TP / Modbus RTU

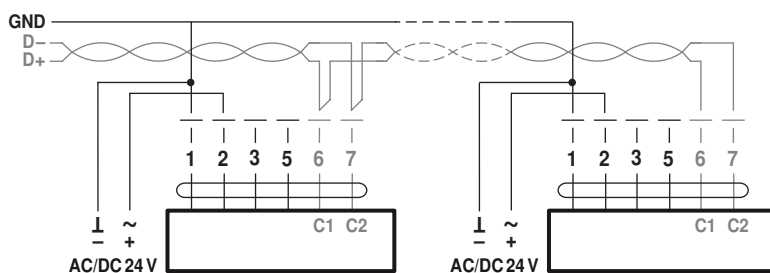

Cable colours:

- 1 = black
- 2 = red
- 3 = white
- 5 = orange
- 6 = pink
- 7 = grey

BACnet / Modbus signal assignment:

- C1 = D- = A
- C2 = D+ = B

Electrical installation

Connection with passive sensor, e.g. Pt1000, Ni1000, NTC

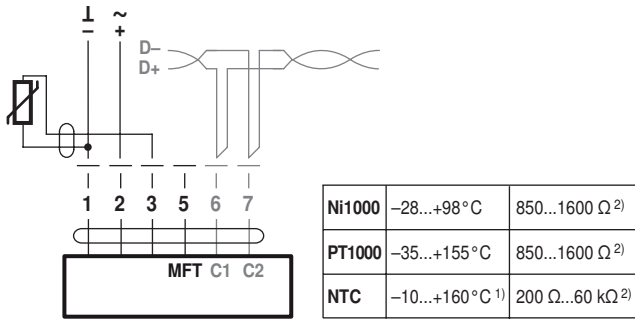

1) depending on type
2) Resolution 1 Ohm

Connection with active sensor, e.g. 0...10 V @ 0...50°C

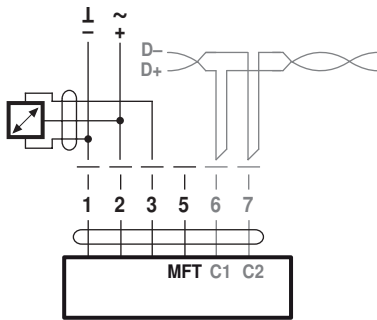

Possible voltage range:
0...32 V (resolution 30 mV)

Connection with switching contact, e.g. Δp monitor

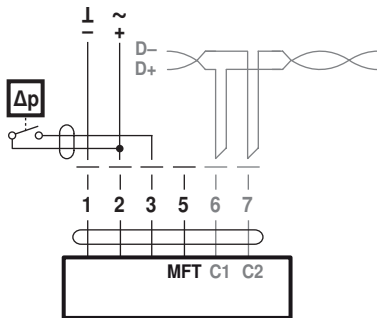

Requirements for switching contact:
The switching contact must be able to accurately switch a current of 16 mA @ 24 V.

Modbus RTU / BACnet MS/TP with analogue setpoint (hybrid mode)

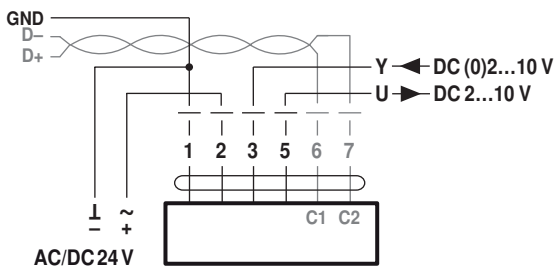

Electrical installation

Operation on the MP-Bus

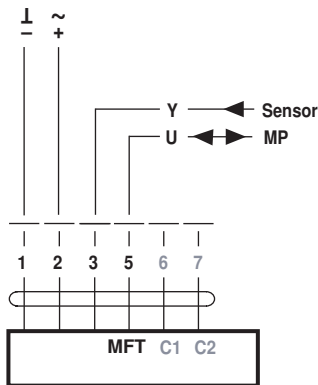

Operating controls and indicators

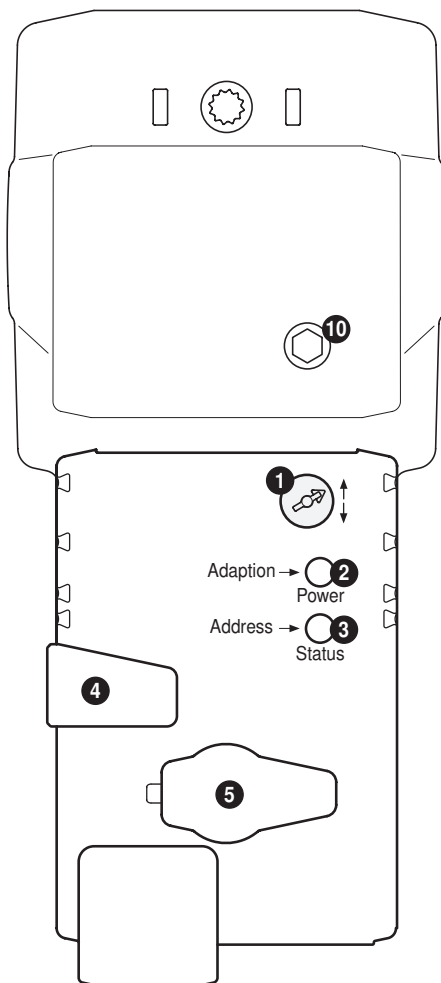

1 Direction of stroke switch

Switch over: Direction of stroke changes

2 Push-button and LED display green

Off: No power supply or malfunction
 On: In operation
 Flashing: In address mode: Pulses according to set address (1...16)
 When starting: Reset to factory setting (Communication)
 Press button: In standard mode: Triggers stroke adaptation
 In address mode: Confirmation of set address (1...16)

3 Push-button and LED display yellow

Off: Standard mode
 Flickering: BACnet / Modbus communication active
 On: Adaptation or synchronising process active
 or actuator in address mode (LED display green flashing)
 Press button: In operation (>3 s): Switch address mode on and off
 In address mode: Address setting by pressing several times
 When starting (>5 s): Reset to factory setting (Communication)

4 Gear disengagement button

Press button: Gear disengages, motor stops, manual override possible
 Release button: Gear engages, synchronisation starts, followed by standard mode

5 Service plug

For connecting parameterisation and service tools

10 Manual override

Clockwise: Actuator spindle extends
 Counterclockwise: Actuator spindle retracts

Service

- Quick addressing**
1. Press the "Address" button until the green "Power" LED is no longer illuminated. LED flashes in accordance with the previously set address.
 2. Set the address by pressing the "Address" button the corresponding number of times (1...16).
 3. The green LED flashes in accordance with the address that has been entered (...16). If the address is not correct, then this can be reset in accordance with Step 2.
 4. Confirm the address setting by pressing the green "Adaption" button.
- If no confirmation occurs for 60 seconds, then the address procedure is ended. Any address change that has already been started will be discarded.
The resulting BACnet MS/TP and Modbus RTU address is made up of the set basic address plus the short address (e.g. 100+7=107).

Service Tools connection The actuator can be parametrised by ZTH EU via the service socket. For an extended parametrisation the PC tool can be connected.

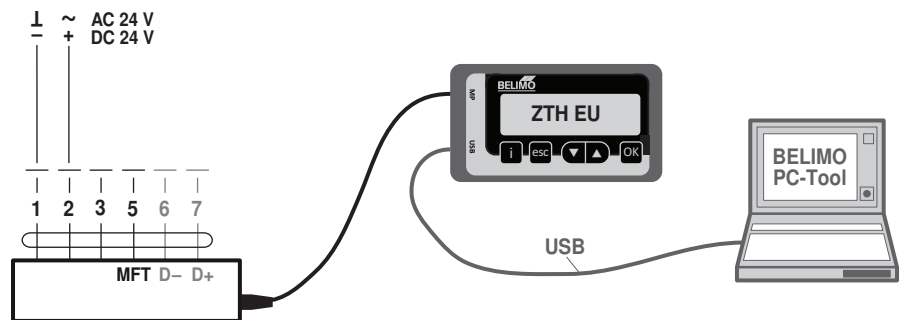

Dimensions [mm]

Dimensional drawings

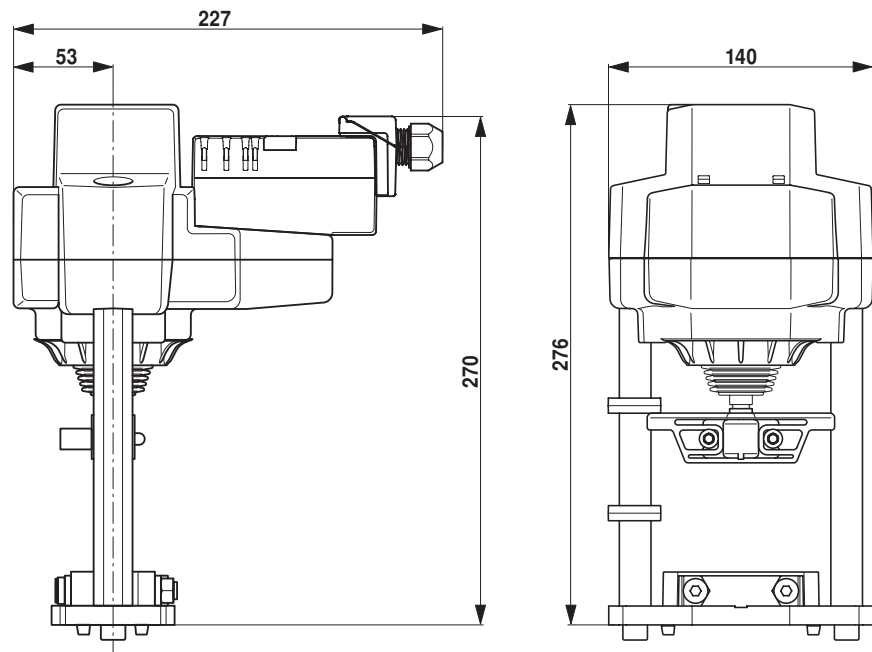

Further documentation

- Tool connections
- Description Protocol Implementation Conformance Statement PICS
- Description Modbus register
- Overview MP Cooperation Partners
- MP Glossary
- Introduction to MP-Bus Technology
- The complete product range for water applications
- Data sheets for globe valves
- Installation instructions for actuators and/or globe valves
- Notes for project planning 2-way and 3-way globe valves
- General notes for project planning