

ACVATIX™

Intelligent Valve - Control valve with integrated energy data acquisition

EVG.., EVF..



Intelligent Valve – control valve with integrated energy data acquisition for ventilation and air conditioning plants as well as precontrol groups. Sensor-guided dynamic flow control.

- Valves with threaded connection EVG4U10E...:
 - DN 15...50
 - Nominal volume flow 1.5...18 m³/h
 - Externally threaded connection per ISO-228
- Flanged valves EVF4U20E...:
 - DN 65...125
 - Nominal volume flow 30...120 m³/h
 - Flange connection per ISO 7005-1
- System integration in building automation and control over BACnet IP
- Supports the direct transfer to Siemens Building Operator
- Ultrasonic flow measurement at measuring accuracy ± 2%
- Temperature measurement with paired immersion temperature sensors

Use

The Intelligent Valve is a 2-port PICV with volume flow, temperature and power measurement for heating, ventilation, and air conditioning plants.

The integration of the valve in the temperature control circuit can be analog (DC 0/2...10 V or 4...20 mA) or digital (BACnet IP). All process data (flow, power, primary flow and return temperature, etc.) can be read out digitally even if analog integrated.

The Intelligent Valve also has local limitation and optimization functions that support energy-efficient plant operation.

In addition to digital integration in the building automation and control system, integration in the cloud with the Siemens Building Operator app supports the building operator to operate and monitor the system as well as evaluate energy consumption.

Technical design

Basic design

The Intelligent Valve combines four main functions:

- Exact, continuous volume flow measurement with an ultrasonic flow sensor
- Precise temperature measurement using paired PT1000 temperature sensors
- Precise volume control using a control valve with an high-resolution actuator
- Dynamic hydraulic balancing, power and energy calculation, data storage and network integration via a central control unit

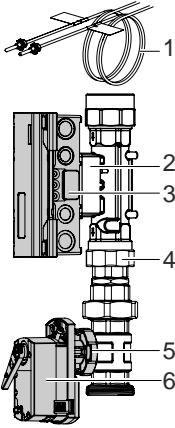
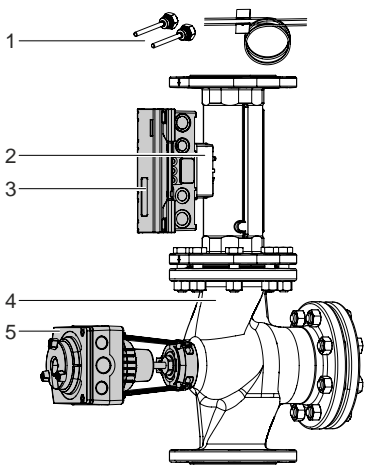
	1	Temperature sensor pair (>DN 50 with protection pockets)	1	
	2	Ultrasonic flow sensor	2	
	3	Intelligent Valve controller – Sensor interface – Dynamic flow control – Power and energy measurement – Optimization of heat exchange – Data storage – Network integration	3	
	4	Flow sensor / valve interface	-	
	5	Flow control valve	4	
	6	High-resolution actuator	5	

Volume flow is acquired continuously in the ultrasonic flow sensor and provided to the Intelligent Valve controller, where the controller applies it as the actual value for control or limitation by guiding the control valve position until achieving the volume flow actual value for the applicable setpoint.

The Intelligent Valve supports three control modes:

- Volume flow control
- Position control
- Output control

Volume flow limitation is active on all four control types!

Volume flow control

In the basic configuration, the Intelligent Valve operates as an electronic PICV. This control type is called volume flow control. The positioning signal is proportional to the volume flow to be controlled (setpoint 0% = closed; setpoint 100% = \dot{V}_{100}). The setpoint range reflects new limit values (setpoint 0% = \dot{V}_{min} , setpoint 100% = \dot{V}_{max}), if volume flow limitation (\dot{V}_{min} and/or \dot{V}_{max}) is activated. In the volume flow control mode, the flow characteristic curve can be adapted to the transfer behavior of the heat exchanger.

Three characteristic curves are available:

Equal percentage, optimized in the opening range (factory setting)

Recommended for heating and cooling registers, if the transfer characteristic is unknown.

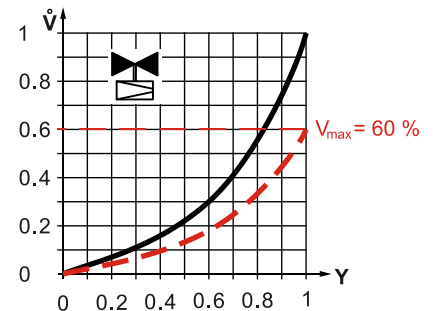

Linear

Recommended for plate heat exchangers water/water or injection circuits in precontrol groups.

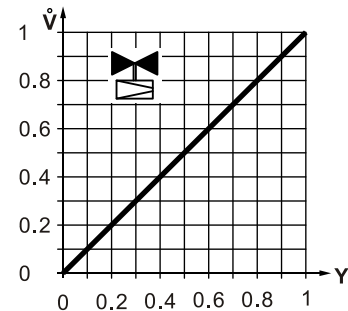

Heat exchanger optimized

Recommended for heating and cooling registers, if the transfer characteristic (a-Value) is known.

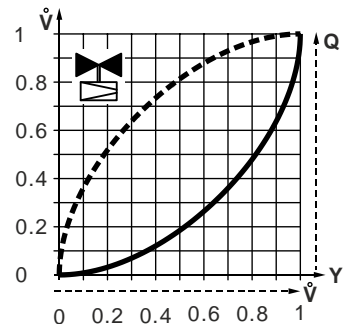

\dot{V} = Volume flow V / V_{100}
 Y = Positioning signal
 Q = Heat output

In the event of volume flow limitation, the curve always adapts to the set limitation setpoint (example for equal percentage curve).

Position control

The control valve position is proportional to the setpoint (setpoint 0% = closed; setpoint 100% = H_{100}) – whereby the limitation to the applicable maximum volume flow (\dot{V}_{100} or \dot{V}_{max}) remains active. Dynamic volume flow control is inactive in position control mode. The flow characteristic curve for the valves with threaded connection EVG.. is equal percentage with a ngl 2.2; the curve for the flanged valves EVF.. is linear.

Output control

The setpoint for the output for control is interpreted by referencing the output limitation ($Y = 0 \dots 100\% \dot{Q}_{max}$; 0% = closed; 100% = \dot{Q}_{max}), whereby \dot{Q}_{max} is the output limitation in %, relating to the design output of the consumption (heat exchanger/precontrol group).

The design output for the heat exchanger is preset as the design volume flow \dot{V}_{max} and design temperatures $T_{VL, design}$ and $T_{RL, design}$:

$$\dot{Q}_{design} \sim \dot{V}_{max} \cdot (T_{VL, design} - T_{RL, design}).$$

The "Sizing" section provides a table of the output values for water at typical temperature differentials (page 5).

The volume flow maximum limitation (\dot{V}_{100} or \dot{V}_{max}) also remains active in the output control mode. In output control, the dynamic volume flow control is inactive, since any undesired change in volume flow automatically results in a change in output, which is not controlled anyway.

The flow characteristic curve is not relevant to output control.

Operating limits

The nominal volume flow and minimum required differential pressure – the Intelligent Valve has, as does any dynamic PICV, a nominal flow \dot{V}_{100} by build design that may not be breached during operation. A minimum differential pressure (Δp_{min}) is calculated from the Intelligent Valve k_{vs} value to achieve the nominal volume flow. In contrast to mechanical PICVs, the electronic volume flow control on the Intelligent Valve remains active below the minimum differential pressure – so that the network is always optimally balanced.

The Intelligent Valve supports different limitation functions:

- Volume flow maximum limitation
- Volume flow minimum limitation
- Output maximum limitation
- Return air temperature min./max. limitation

Volume flow maximum limitation

We recommend activating the volume flow maximum limitation if the design volume flow for the partial plant (heating coil/cooler/precontrol group) controlled by the Intelligent Valve, is lower than the nominal flow of the Intelligent Valve. In volume flow control mode, the set volume flow \dot{V}_{max} – anywhere between 30 and 100% of the nominal volume flow – is interpreted as the 100% setpoint. It serves as just the limitation value in the other control modes.

Volume flow minimum limitation

The volume flow minimum limitation achieves a minimum flow through the controlled partial plant where this appears to be appropriate. The limitation is of course pressure-independent so that there is no over or under supply as the local differential pressure changes.

Output maximum limitation

In contrast to volume flow limitation, the output limitation adapts dynamically to the temperature distribution on the plant. As a consequence, output control is more analogous to a volume flow limitation for critical users.

Return air temperature min./max. limitation

Modern, high-efficiency output generators must have sufficient low/high return temperatures to achieve their output numbers/degree of efficiency. With Intelligent Valve, you can precisely limit the return temperature value as needed by the given plant.

A return temperature maximum limitation is available if the Intelligent Valve is used on a heating application; in a cooling application it has a return temperature minimum limitation at its disposal. The settings are in two steps: Enable the function (1) and set the limitation setpoint (2). The factory setting for maximum limitation is = 40 °C; minimum limitation = 10 °C.

Not all limitations are available to each control mode. The following limitations are available based on control mode:

	Position control	Volume flow control	Output control
Setpoint	External		
Volume flow maximum limitation	Always active		
Volume flow minimum limitation	Selectable		
Output maximum limitation	-		Always active
Return temperature limitation	Selectable		

Sizing

As a pressure-independent solution, it is generally easy to size the Intelligent Valve. If the volume flow is already a known variable, simply select the corresponding valve from the diagram below. The volume flow for control should be between 30 and 90% of the nominal volume flow of the Intelligent Valve.

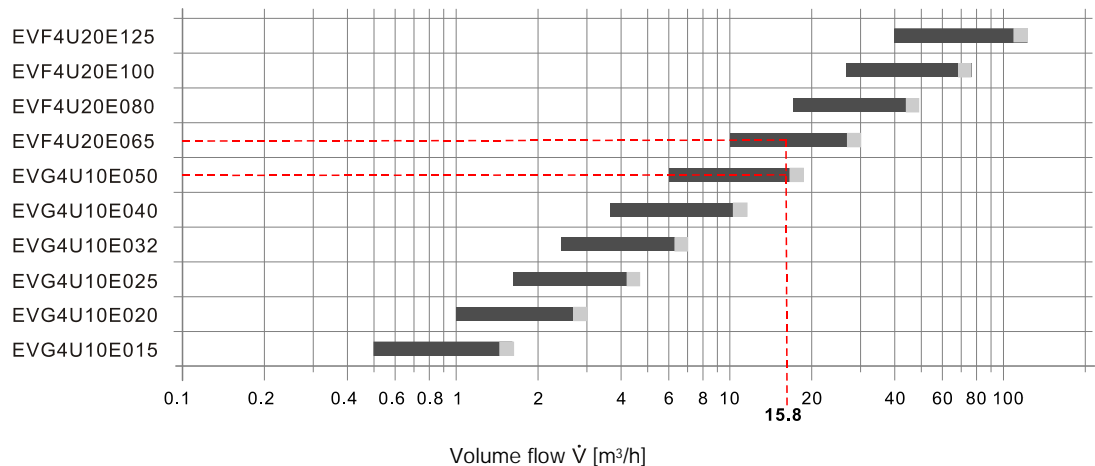

■ = Reasonable usable range for presetting flow

■ = 90...100% of \dot{V}_{100}

Example	
Required volume flow \dot{V}_{max}	Intelligent Valve selection
15.8 m³/h	EVG4U10E050: $\dot{V}_{100} = 18 \text{ m}^3/\text{h} \Rightarrow \dot{V}_{max} = 88\%$
	EVF4U20E065: $\dot{V}_{100} = 30 \text{ m}^3/\text{h} \Rightarrow \dot{V}_{max} = 53\%$

Maximum consumer output range at typical temperature differentials:

Type	Order number	DN	\dot{V}_{100} [m³/h]	\dot{Q} [kW] at			
				ΔT 6 K	ΔT 10 K	ΔT 15 K	ΔT 20 K
EVG4U10E015	S55300-M100	15	1.5	10.4	17.4	26.1	34.5
EVG4U10E020	S55300-M101	20	3	20.9	34.8	52	70
EVG4U10E025	S55300-M102	25	4.5	31.3	52	78	104
EVG4U10E032	S55300-M103	32	7	49	81	122	162
EVG4U10E040	S55300-M104	40	11.5	80	133	200	267
EVG4U10E050	S55300-M105	50	18	125	209	313	418
EVF4U20E065	S55300-M106	65	30	209	348	522	696
EVF4U20E080	S55300-M107	80	48	334	557	835	1114
EVF4U20E100	S55300-M108	100	75	522	870	1305	1740
EVF4U20E125	S55300-M109	125	120	835	1392	2088	2784

Engineering example

Calculation basis

1. Determination of heating or cooling demand \dot{Q} [kW]
2. Determination of temperature differential ΔT [K]
3. Calculation of volume flow

$$\dot{V} \left[\frac{\text{m}^3}{\text{h}} \right] = \frac{Q[\text{kW}] \cdot 3600[\text{s}]}{4190 \frac{\text{kJ}}{\text{kgK}} \cdot \Delta T[\text{K}]}$$
- 4.
5. Select the suitable Intelligent Valve EV..



Example

1.	Heating/cooling power	$\dot{Q} = 110 \text{ kW}$
2.	Temperature spread	$\Delta T = 6 \text{ K}$
3.	Volume flow	$\dot{V} \left[\frac{\text{m}^3}{\text{h}} \right] = \frac{110 \text{ kW} \cdot 3600 \text{ s}}{4190 \frac{\text{kJ}}{\text{kg K}} \cdot 6 \text{ K}} = 15,8 \frac{\text{m}^3}{\text{h}}$ <p>Note: You can use the valve slider to determine volume flow.</p>
4.	Select EV.. Select the Intelligent Valve to operate at 90% of the nominal volume flow. This permits setting higher heat or cooling output as needed.	
	Selection:	EVG4U10E050 $\Delta p_{\min} = 28 \text{ kPa}$ EVF4U20E065 $\Delta p_{\min} = 8 \text{ kPa}$
5.	Assess presetting EVG4U10E050: $15.8 / 18 = 88\%$ EVF4U20E065: $15.8 / 30 = 53\%$	Optimum selection

Sizing diagram

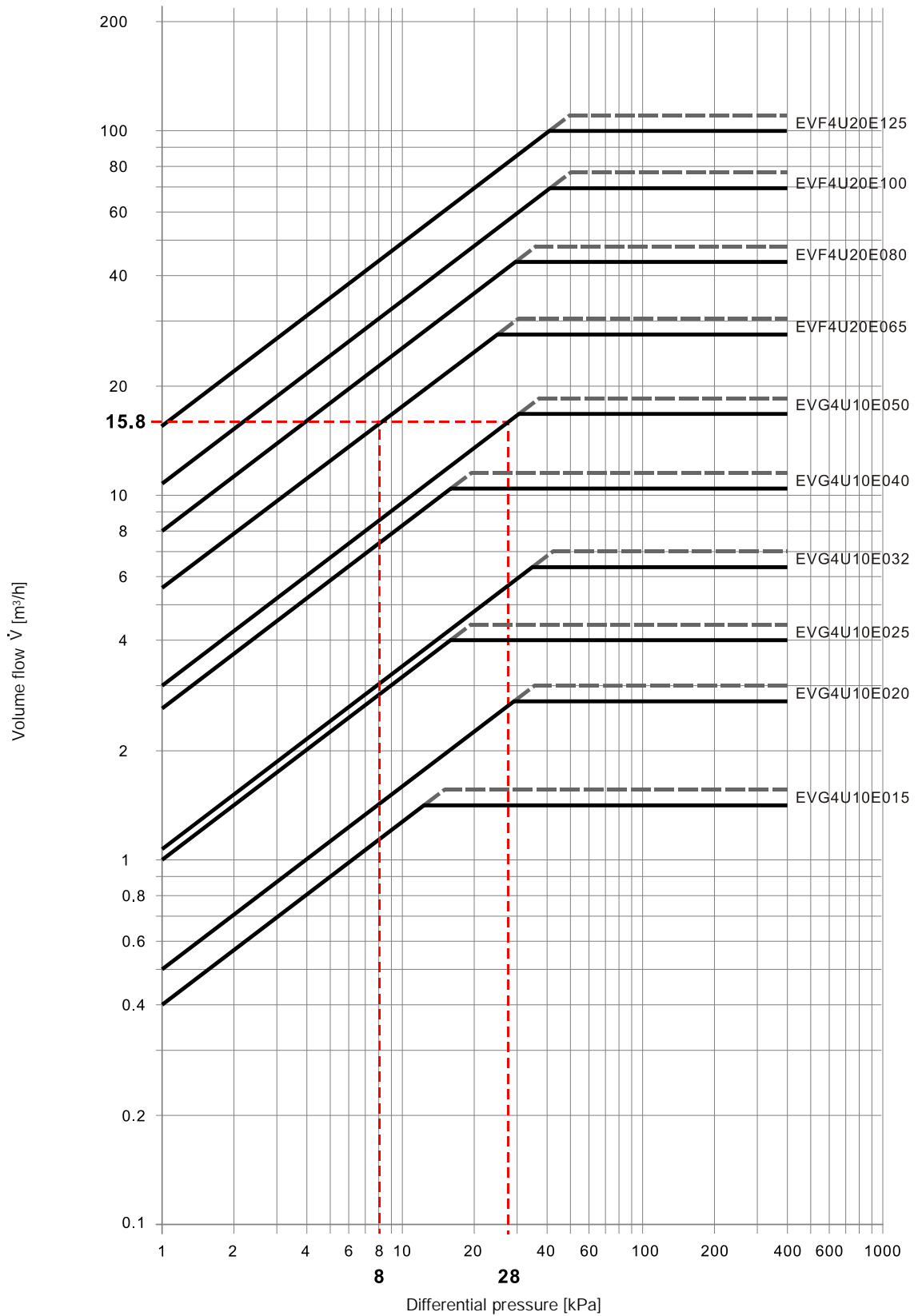
You can rely on the k_{vs} value under Type summary (page 8) to determine the pressure drop at the requested maximum volume flow.



-  = Reasonable usable range for presetting flow
-  = 90...100% of \dot{V}_{100}

Calculated volume flow \dot{V}	Intelligent Valve selection	Differential pressure [kPa]
15.8 m ³ /h	EVG4U10E050	28
	EVF4U20E065	8

Type summary

Intelligent Valve with threaded connection EVG4U10E..

Type	Order number	DN	\dot{V}_{100} [m ³ /h]	\dot{V}_{min} [m ³ /h]	Δp_{max} [kPa]	Δp_s [kPa]	k_{vs} [m ³ /h]
EVG4U10E015	S55300-M100	15	1.5	0.5	350	1400	4
EVG4U10E020	S55300-M101	20	3	1			5
EVG4U10E025	S55300-M102	25	4.5	1.5			10
EVG4U10E032	S55300-M103	32	7	2.3		1000	11
EVG4U10E040	S55300-M104	40	11.5	3.5		800	26
EVG4U10E050	S55300-M105	50	18	6		600	30

Flanged Intelligent Valve EVF4U20E..

Type	Order number	DN	\dot{V}_{100} [m ³ /h]	\dot{V}_{min} [m ³ /h]	Δp_{max} [kPa]	Δp_s [kPa]	p_s [kPa]	k_{vs} [m ³ /h]
EVF4U20E065	S55300-M106	65	30	10	500	1600	1500	55
EVF4U20E080	S55300-M107	80	48	16			1200	80
EVF4U20E100	S55300-M108	100	75	25			1600	113
EVF4U20E125	S55300-M109	125	120	40				142

- DN = Nominal size
 \dot{V}_{100} = Volumetric flow through fully open valve
 \dot{V}_{min} = Smallest presettable volumetric flow through fully open valve
 Δp_{max} = Maximum permissible differential pressure across the valve's control path, valid for the entire actuating range of the motorized valve
 Δp_s = Maximum permissible differential pressure at which the motorized valve will close securely against the pressure (close off pressure)
 p_s = Permissible operating pressure
 k_{vs} = Flow nominal value of cold water (5...30 °C) through fully opened valve at a differential pressure of 100 kPa (1 bar)

Scope of delivery

The Intelligent Valve is supplied as a complete set consisting of:

EVG.. with threaded connection	EVF.. flanged
Intelligent Valve controller	
Actuator	
Flow section (control valve and flow sensor are preinstalled)	Flow sensor
	Control valve
Temperature sensor pair for direct mounting (order protection pockets separately)	Temperature sensor pair including protection pockets

The device is not supplied without fittings, mating flange, and gaskets.

Accessories

Type	Order number	Designation	
EZT-M40	S55845-Z231	Protection pockets, brass, for DN 15...50	DN 65...125 include protection pockets!
EZU-WA	S55845-Z234	Wall mount for Intelligent Valve controller	Use at high media temperatures (>90 °C)
ALX15	S55845-Z174	Filter with internal threading, DN 15	Filter
ALX20	S55845-Z175	Filter with internal threading, DN 20	
ALX25	S55845-Z176	Filter with internal threading, DN 25	
ALX32	S55845-Z177	Filter with internal threading, DN 32	
ALX40	S55845-Z178	Filter with internal threading, DN 40	
ALX50	S55845-Z179	Filter with internal threading, DN 50	
QBE3000-D1.6	S55720-S174	Differential pressure sensor for fluids and gas (0...10 V)	
QBE3000-D2.5	S55720-S175		0...2.5 bar
QBE3000-D4	S55720-S176		0...4 bar

Spare parts

Type	Order number	Designation
ASE4U10E	S55845-Z205	Intelligent Valve controller for PICV, series EVG4U.. and EVF4U..
AVG4E015VAG	S55845-Z223	Control valve section PN 16 for Intelligent Valve EVG4..1.E015, DN 15 with threaded connection, k_{vs} 4 m ³ /h
AVG4E020VAG	S55845-Z224	Control valve section PN 16 for Intelligent Valve EVG4..1.E020, DN 20 with threaded connection, k_{vs} 5 m ³ /h
AVG4E025VAG	S55845-Z225	Control valve section PN 16 for Intelligent Valve EVG4..1.E025, DN 25 with threaded connection, k_{vs} 10 m ³ /h
AVG4E032VAG	S55845-Z226	Control valve section PN 16 for Intelligent Valve EVG4..1.E032, DN 32 with threaded connection, k_{vs} 11 m ³ /h
AVG4E040VAG	S55845-Z227	Control valve section PN 16 for Intelligent Valve EVG4..1.E040, DN 40 with threaded connection, k_{vs} 26 m ³ /h
AVG4E050VAG	S55845-Z228	Control valve section PN 16 for Intelligent Valve EVG4..1.E050, DN 50 with threaded connection, k_{vs} 30 m ³ /h
AVF4E065	S55845-Z213	Ultrasonic flow sensor for Intelligent Valve DN 65 mounting length 300 mm, flanged DN 65, PN 16
AVF4E080	S55845-Z214	Ultrasonic flow sensor for Intelligent Valve DN 80 mounting length 300 mm, flanged DN 80, PN 16
AVF4E100	S55845-Z215	Ultrasonic flow sensor for Intelligent Valve DN 100 mounting length 360 mm, flanged DN 100, PN 16
AVF4E125	S55845-Z216	Ultrasonic flow sensor for Intelligent Valve DN 125 mounting length 360 mm, flanged DN 100, PN 16
ALF4E065	S55845-Z218	Control valve mounting set PN16 for Intelligent Valve DN 65 (EVF4..2..E065), flanged
ALF4E080	S55845-Z219	Control valve mounting set PN16 for Intelligent Valve DN 80 (EVF4..2..E080), flanged
ALF4E100	S55845-Z220	Control valve mounting set PN16 for Intelligent Valve DN 100 (EVF4..2..E100), flanged
ALF4E125	S55845-Z221	Control valve mounting set PN16 for Intelligent Valve DN 125 (EVF4..2..E125), flanged

Type	Order number	Designation
EZU10-2615	S55845-Z229	Temperature sensor pair Pt1000, DS M10x1, Ø 5.2 x 26 mm, cable length 1.5 m
EZU10-10025	S55845-Z230	Temperature sensor pair Pt1000, PL Ø 6 x 105 mm, cable length 2.5 m
EZT-S100	S55845-Z232	Protection pocket G ½ B", G ¼ B", stainless steel, Ø 6.2 x 92.5 mm, for temperature sensors Ø 6 x 105 mm
GLA161.9E/HR	S55499-D444	Rotary actuator for ball valves, AC/DC 24 V, 10 Nm, NSR, modulating 0...10 V Highly accurate positioning signal, only for use with Intelligent Valve EVG4U10E..
SAX61.03/HR	S55150-A142	Valve actuator 800 N, 20 mm stroke, AC/DC 24 V, modulating 0...10 V Highly accurate positioning signal, only for use with Intelligent Valve EVF4U20E.., DN 65 and DN 80
SAV61.00/HR	S55150-A146	Valve actuator 1600 N, 40 mm stroke, AC/DC 24 V, modulating 0...10 V Highly accurate positioning signal, only for use with Intelligent Valve EVF4U20E.., DN 100 and DN 125

Product documentation

Title	Content	Document ID
Intelligent Valve - Control valve with integrated energy data acquisition	Data sheet: Product description EVG.., EVF..	A6V11444716
Rotary actuators for ball valves together with the Intelligent Valve Controller	Data sheet: Product description GLA161.9E/HR	A6V11418678
Electromotive actuator in combination with the Intelligent Valve Controller	Data sheet: Product description SAX61.03/HR, SAV61.00/HR	A6V11418660
Actuators SAX.., SAY.., SAV.., SAL.. for valves	Basic document: Comprehensive information on the new generation of SAX.., SAV.. actuators	P4040
EVF.. / EVG..	Mounting Instructions	A6V11449479
GLA161.9E/HR	Mounting Instructions	A6V11418688
AVG4..VAG	Mounting Instructions	A6V11449852
AVF4..	Mounting Instructions	A6V11478285
Readme OSS "Intelligent Valve – 1.1"	OSS document Open source software components, copyright holders, license conditions	A6V11676101

Related documents such as environmental declarations, CE declarations, etc., can be downloaded at the following Internet address:

<http://siemens.com/bt/download>

Note concept

The safety notices must be observed in order to protect people and property.

The safety notices in this document contain the following elements:

- Symbol for danger
- Signal word
- Nature and origin of the danger
- Consequences if the danger occurs
- Measures or prohibitions for danger avoidance

Symbol for danger



This is the symbol for danger. It warns of **risks of injury**.

Follow all measures identified by this symbol to avoid injury or death.

Additional danger symbols

These symbols indicate general dangers, the type of danger or possible consequences, measures and prohibitions, examples of which are shown in the following table:



General danger



Explosive atmosphere



Voltage/electric shock



Laser light



Battery



Heat

Signal word

The signal word classifies the danger as defined in the following table:

Signal word	Danger level
DANGER	'DANGER' identifies a dangerous situation, which will result directly in death or serious injury if you do not avoid this situation.
WARNING	'WARNING' identifies a dangerous situation, which may result in death or serious injury if you do not avoid this situation.
CAUTION	'CAUTION' identifies a dangerous situation, which could result in slight to moderately serious injury if you do not avoid this situation.
<i>NOTICE</i>	' <i>NOTICE</i> ' identifies a possibly harmful situation or possible damage to property that may result from non-observance. ' <i>NOTICE</i> ' does not relate to possible bodily injury.

How risk of injury is presented

Information about the risk of injury is shown as follows:

	▲ WARNING
	Nature and origin of the danger Consequences if the danger occurs <ul style="list-style-type: none">• Measures / prohibitions for danger avoidance

How possible damage to property is presented

Information about possible damage to property is shown as follows:

	NOTICE
	Nature and origin of the danger Consequences if the danger occurs <ul style="list-style-type: none">• Measures / prohibitions for danger avoidance

Safety

	▲ CAUTION
	National safety regulations Failure to comply with national safety regulations may result in personal injury and property damage. <ul style="list-style-type: none">• Observe national provisions and comply with the appropriate safety regulations.

Qualified personnel

	NOTICE
	Qualified personnel! Improper installation can invalidate safety precautions not otherwise discernable to an ordinary person. <ul style="list-style-type: none">• Technical knowledge of HVAC plants required for installation.• Only qualified personnel may undertake the installation.• Prevent access by ordinary persons, especially children.

All personnel must be persons who can be reasonably expected to work reliably and conscientiously. Persons whose ability to react is impaired, e.g. by drugs, alcohol or medication, are prohibited from working with the devices.

Heating technician

Due to their specialist training, knowledge and experience, as well as knowledge of relevant standards and regulations, the heating technician is able to perform mechanical tasks on HVAC plants and independently recognize possible dangers and avoid them.

The heating technician is trained specially for the working environment they are operating in, and knows the relevant standards and regulations.

An unhindered inlet section of $L = 5 \times DN$ must be maintained upstream of the flow sensor to guarantee the indicated measurement and control accuracy.

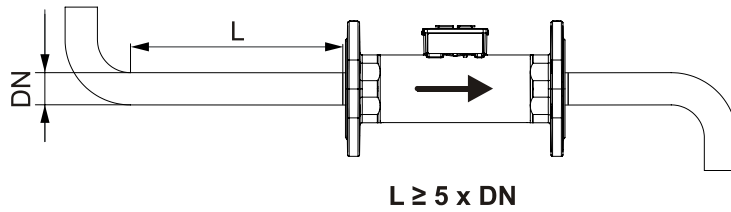

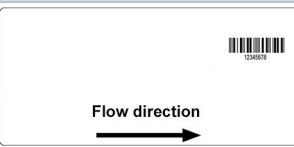
Valve.	Symbol / flow direction EVG.. / EVF..	Flow in control mode		Valve stem	
		Input	Output	SAX.. / SAV.. Retracts	SAX.. / SAV.. Extends
				GLA.. Clockwise rotation	GLA.. Counterclockwise rotation
Intelligent Valve		Variable		Closes	Opens



The indicated flow direction (arrow on the flow sensor and valve body) must be correct; the Intelligent Valve cannot otherwise be operated!

The rule is: First measure, then control – in other words, the flow sensor must always be mounted upstream of the control valve.

The Intelligent Valve should be installed in the return for optimum performance. The components are subject to less wear and tear due to the lower temperatures.

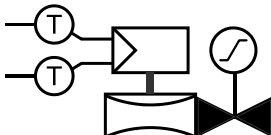
Symbol in catalogs and application descriptions	Symbol in diagrams
	There are no standard symbols for PICVs in the diagrams

We recommend installing a filter or strainer, e.g. ALX., in the flow to the heat exchanger. This increases the reliability and life cycle of the Intelligent Valve.

Mounting

The Intelligent Valve is assembled at the mounting location. No adjustments, with the exception of configuring with the ABT Go app (see 'Commissioning', page 16) nor special tools required. Separating mounting instructions are included with the valve and flow sensor.

Mounting positions

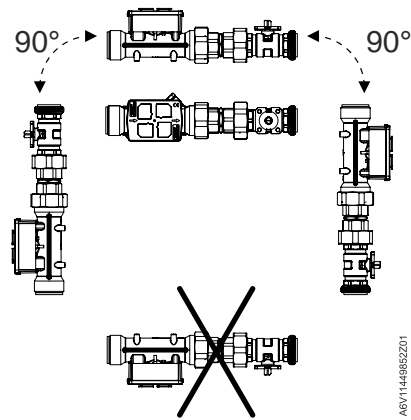

Mount the flow sensor in the return if the media temperatures exceed (>90 °C). If not possible, mount the Intelligent Valve controller remotely from the flow sensor and use the wall-mount plate EZU-WA.

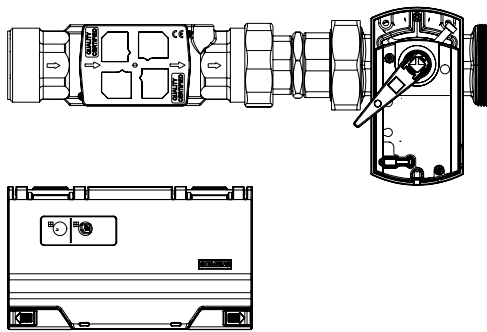

Mount temperature sensors

Valves with threaded connection **EVG4U10E..**

The EVG.. valves with threaded connection are supplied with direct immersion temperature sensors EZU10-2615.

The sensors with the M10x1 threaded connection can be directly immersed in the flow sensor. The second temperature sensor is also directly immersed with the WZT-G10 welding sleeve.

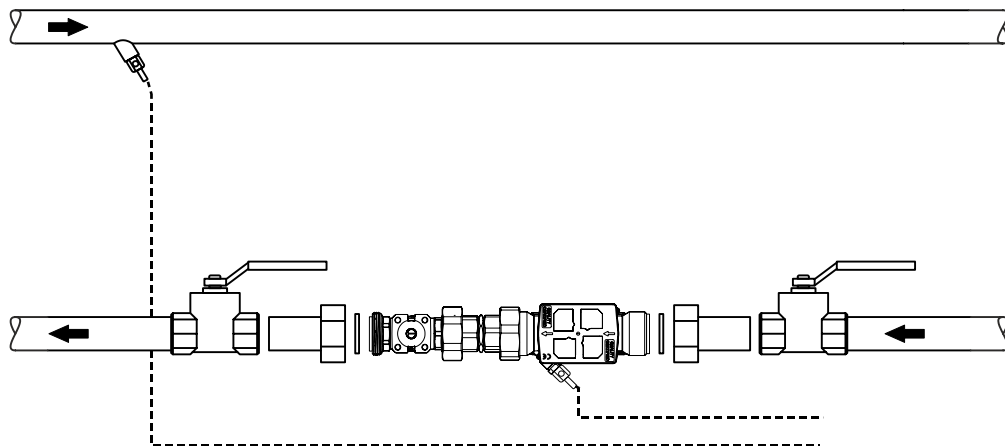

As an alternative, the sensors can be installed directly immerse in off-the-shelf ball valves with integrated measuring points (e.g. Siemens WZT-K.. / Jumo 902442/11) or t-pieces (e.g. Jumo 902442/31).

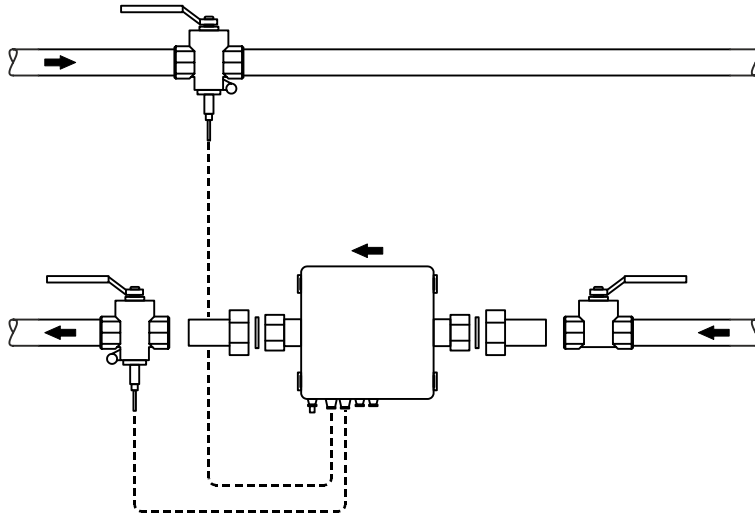

The brass protection pocket EZT-M40 is available for mounting with protection pockets.

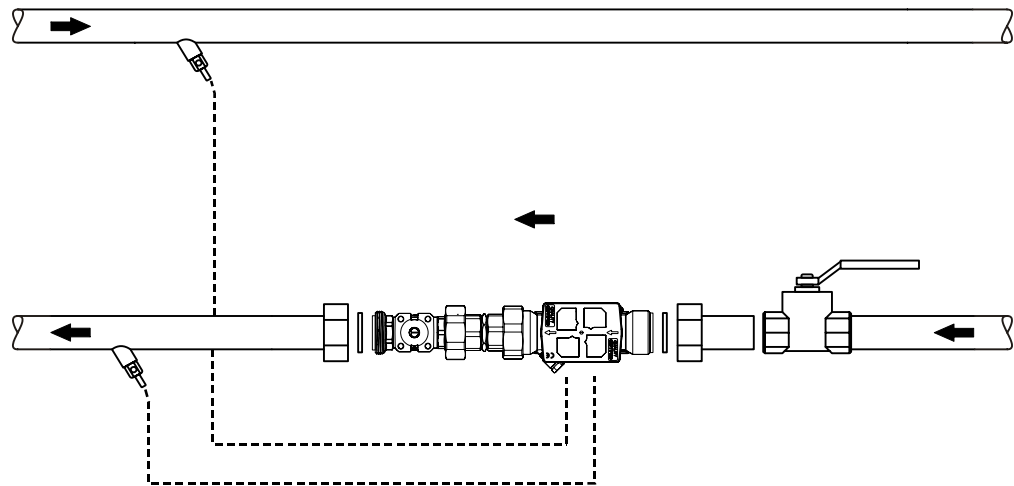

Flanged valves **EVF4U20E..**

The EVF.. flanged valves include the temperature sensors EZU10-10025 for installing in the protection pockets EZT-S100.

Welding sleeves must be planned on the construction side (e.g. WZT-G12) – installation example with protection pocket.

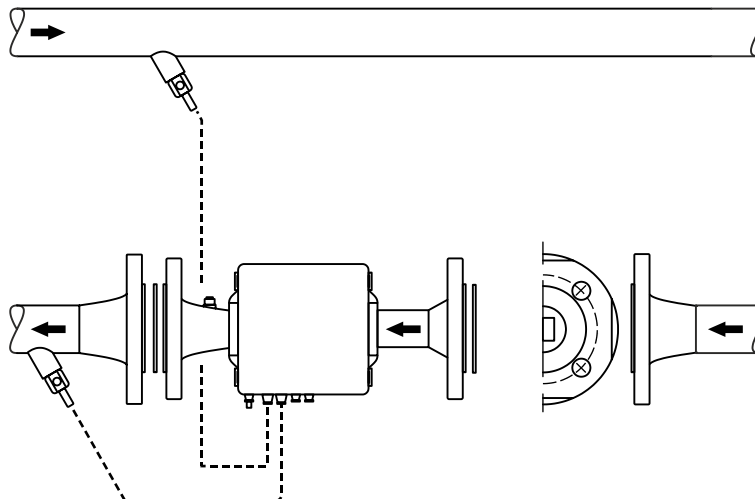

Commissioning

The device has only a simple user interface.

Siemens ABT Go app is used to actually commission the device.

ABT Go App

The Siemens ABT Go app is available in iOS and Android versions in the corresponding app stores and can be used on smartphones and tablets. It connects directly over WLAN. The Intelligent Valve's own WLAN key activates the device's WLAN access point.

The following are the most important setting parameters for commissioning the Intelligent Valve:

Parameter	Value range	Description	Factory setting	Access level
Control mode	Position control Volume flow control Output control	See "Control modes" (page 3)	Air volume control	Measuring and control technician
\dot{V}_{max}	30...100%	Maximum volume flow applicable to all control modes. It is used for hydraulic balancing of the consumer. Can be set in the ABT Go app in the units m ³ /h, l/h, l/min or l/s.	Active 100%	Installer
\dot{V}_{Min}	2,5...20%	Minimum volume flow applicable to all control modes. Can be set in the ABT Go app in the units m ³ /h, l/h, l/min or l/s.	Inactive	Installer
Setpoint source	Terminal BACnet IP local	Selection whether to interpret input X1 as the setpoint, whether it originates from a BACnet network, or whether it is set locally to a fixed value.	Terminal	Measuring and control technician
Setpoint signal	0...10 V 2...10 V 4...20 mA	Signal type pending at input X1	0...10 V	Measuring and control technician
Actual value parameter	Position Volume flow 0...V ₁₀₀	Selection whether the analog signal at output X2 depicts the valve position or volume flow. For volume flow, 0...V ₁₀₀ = 0...100% is depicted	Volume flow 0...V ₁₀₀	Measuring and control technician
Actual value signal type	0...10 V 2...10 V 4...20 mA	Signal type pending at output X2	-	Measuring and control technician
Flow characteristics	Linear Equal percentage	The flow characteristic flow can be selected in the volume flow control operating mode.	Equal percentage	Measuring and control technician

User interface on the device

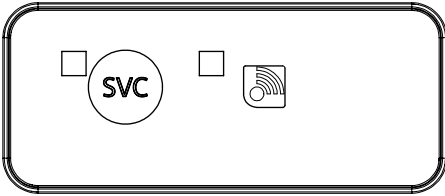
Service LED <ul style="list-style-type: none"> Indicates the operating state (see table below) 	Communication LED <ul style="list-style-type: none"> Indicates the communication state (see table below)
	
Service button <ul style="list-style-type: none"> Overrides the setpoint and sets \dot{V}_{max} for 10 minutes (press for 3...6 s) Start the flow test (press 6...8 s) 	WLAN button <ul style="list-style-type: none"> Enables the integrated WLAN access point for 10 min

Service LED			SVC
Color	Blinking pattern		Description
	On	Off	
Green	0.5 s	0.5 s	Device in configuration mode
	4.75 s	0.25 s	Normal operation
	0.25 s	0.25 s	Stop local forced control
Blue	0.5 s	0.5 s	Local forced control – Flow test
Yellow	0.5 s	0.5 s	Local forced control – Continuous nominal flow
Red	0.5 s	0.5 s	Fault input/output or component: <ul style="list-style-type: none"> • Flow sensor <ul style="list-style-type: none"> - Wrong direction of flow - Air in sensor - Sensor connection faulty • Temperature sensor <ul style="list-style-type: none"> - Damaged cable - Short circuit. • Actuator <ul style="list-style-type: none"> - Blocked - Faulty connection • Setpoint input terminal <ul style="list-style-type: none"> - Faulty connection - Invalid signal
			Continuous
-	-	-	Undervoltage / Device starts up

Communication LED			
Color	Blinking pattern		Description
	On	Off	
-	-	-	<ul style="list-style-type: none"> • No communication • Ethernet cable unplugged • Start-up
Blue	0.5 s	0.5 s	WLAN enabled
	Continuous	-	Data transmission WLAN
Green	0.5 s	0.5 s	TCP/IP communications error – IP address not available
	Continuous	-	TCP/IP data transmission
	Continuous	-	RS485 data transmission

Network integration

The Intelligent Valve can be integrated over TCP/IP in a BACnet IP network. A complete list of supported BACnet data points is included in the document "Intelligent Valve BACnet system integration".

ABT Go app configures the network parameters.

Maintenance

Control valves EVF.. and EVG.. are maintenance free.

Disposal



The device is considered an electronic device for disposal in terms of the European Directive and may not be disposed of as domestic waste.

- Use only designated channels for disposing the devices.
- Comply with all local and currently applicable laws and regulations.

Warranty service

Bestimmungsgemässe Verwendung



⚠ WARNING

Proper use

Improper use can lead to injuries as well as damage to the device or plant.

- Siemens products may only be used for the applications described in the catalog and in the relevant technical documentation.
- User-related technical data are only guaranteed in connection with the products listed in this document. Siemens rejects any and all warranties in the event that third-party products are used.
- Proper transport, storage, installation, assembly, commissioning, operation and maintenance are required to ensure that the products operate safely and without problems.
- The permissible ambient conditions must be complied with. The information in the relevant technical documentation must be observed.

Liability disclaimer

The contents of this document have been checked for consistency with the hardware and firmware described. Since deviations cannot be precluded entirely, we cannot guarantee full agreement. However, the information provided in this document is reviewed regularly and necessary corrections are included in subsequent editions. Suggestions for improvement are welcome.

Radio equipment directive

The device is using harmonized frequency in Europe, and is also in compliance with the Radio Equipment Directive (2014/53/EU, formerly 1999/5/EC).

Open Source Software (OSS)

Software License Summary

These devices incorporate open source software (OSS), please refer to the OSS document for the specific controller type and valid version set.

Title: Readme OSS "Intelligent Valve – 1.1"

All open source software components used within the product (including their copyright holders and the license conditions) can be found in the document A6V11676101 at <http://siemens.com/bt/download>.

Cyber security disclaimer

Siemens provides a portfolio of products, solutions, systems and services that includes security functions that support the secure operation of plants, systems, machines and networks. In the field of Building Technologies, this includes building automation and control, fire safety, security management as well as physical security systems.

In order to protect plants, systems, machines and networks against cyber threats, it is necessary to implement – and continuously maintain – a holistic, state-of-the-art security concept. Siemens' portfolio only forms one element of such a concept.

You are responsible for preventing unauthorized access to your plants, systems, machines and networks which should only be connected to an enterprise network or the internet if and to the extent such a connection is necessary and only when appropriate security measures (e.g. firewalls and/or network segmentation) are in place. Additionally, Siemens' guidance on appropriate security measures should be taken into account. For additional information, please contact your Siemens sales representative or visit

<https://www.siemens.com/global/en/home/company/topic-areas/future-of-manufacturing/industrial-security.html>.

Siemens' portfolio undergoes continuous development to make it more secure. Siemens strongly recommends that updates are applied as soon as they are available and that the latest versions are used. Use of versions that are no longer supported, and failure to apply the latest updates may increase your exposure to cyber threats. Siemens strongly recommends to comply with security advisories on the latest security threats, patches and other related measures, published, among others, under

<https://www.siemens.com/cert/en/cert-security-advisories.htm>.

Dimensions and weight

See "Dimensions" (page 27)

Power supply	EVG4U10E..	EVF4U20E.. DN 65...80	EVF4U20E.. DN 100...125
Operating voltage	AC 24 V ~ ±20% (19.2...28.8 V ~) DC 24 V = ±20% (19.2...28.8 V =)		
Frequency	50 Hz / 60 Hz		
Power consumption including connected field devices			
Operation	5 W	6.25 W	8 W
Normal position	2.7 W	3.5 W	3.5 W
Sizing	8.5 VA	14 VA	16 VA
Power consumption ASE4U10E			
Operation	3.5 W		
Normal position	2 W		
Sizing	6 VA (controller without actuator!)		
Internal fuse	Irreversible		
External fusing of supply line	<ul style="list-style-type: none"> • Fuse slow 6...10 A • Circuit breaker: Max. 13 A, type B, C, D per EN 60898 • Power source with current limitation of max. 10 A 		

Interfaces

Ethernet	Plugs: 2 x RJ45, screened Interface type: 100BASE-TX, IEEE 802.3 compatible Bitrates: 10/100 Mbps, autosensing Protocol: BACnet over UDP/IP
USB (2.0)	Plug: Micro-B Data rate: 1.5 Mbps and 12 Mbps No galvanic isolation to ground
L-bus	Baud rate: 2.4 kBaud Bus power: 10 mA Short-circuit proof Protection against faulty wiring at max. AC 24 V

Function data

Control valve.	EVG4U10E..	EVF4U20E..
Nominal flow	See Type summary (page 8).	
Adjustable flow as [%] of V_{100}	30...100%	
Control accuracy	±6%	
Permissible media	Chilled and hot water	
Medium temperature	1...120 °C	
Operating pressure p_s	1600 kPa	See Type summary (page 8).
Differential pressure $\Delta p_{max} / \Delta p_s$	See Type summary (page 8).	
Valve flow characteristic	Linear or equal percentage, $ngl = 3.0$ VDI/VDE 2173, optimized in closing range	

Control valve.	EVG4U10E..	EVF4U20E..
Leakage rate	Waterproof per EN 60534-4 L/1, improved class 5	0...0.03% of k_{vs} value
Mounting position	Upright to horizontal	
Valve body	Brass	Cast iron
Blank flange	-	
Valve stem, seat, ball	Brass	Stainless steel
Stem sealing gland	EPDM	

Actuator	EVG4U10E.. GLA161.9E/HR	EVF4U20E.. SAX61.03/HR	EVF4U20E.. SAV61.00/HR
Positioning time (at the specified nominal stroke)	90 s	30 s	120 s
Positioning force	-	800 N	1600 N
Nominal torque	10 Nm	-	
Nominal rotational angle	90°		
Nominal stroke	-	20 mm	40 mm

Flow measurement	EVG4U10E..	EVF4U20E..
Ultrasonic volume flow measurement	Yes	
Measuring accuracy	±2%	
Minimum flow measurement	1% of V_{100}	
Material of measuring pipe		
DN 15...50	Brass	-
DN 65	-	Brass
DN 80		Nodular cast iron EN-GJS-500
DN 100...125		Brass

Temperature measurement	EVG4U10E..	EVF4U20E..
Measuring accuracy absolute temperature	±0.6 °C at 20 °C ±0.8 °C at 60 °C (PT1000 EN60751, class B)	
Measuring accuracy temperature difference	±0.2 K at $\Delta T = 20$ K	
Resolution	0.085 °C	
Permissible operating pressure for direct immersion sensor	PN 16	-
Housing for direct immersion sensor DS M10x1; Ø 5.2 x 26 mm, cable length 1.5 m	Stainless steel	-
Protection pocket G ½ B", Ø 6.2 x 92.5 mm, for temperature sensors Ø 6 x 105 mm		
Permissible operational pressure	PN 25	
Material	Brass	Stainless steel

Inputs

The inputs are protected against incorrect wiring AC/DC 24 V.

Positioning signal input, analog (Input X1)			
Type	Range (over range)	Resolution	Input resistance (R _I)
AI 0...10 V	0...10 V (-1...11 V)	1 mV	100 kΩ
AI 2...10 V	2...10 V (1...11 V)	1 mV	100 kΩ
AI 4...20 mA	4...20 mA (0...20 mA)	2.3 μA	<460 Ω
Open connection: Negative voltage -3.1 V (line failure detection)			

Positioning signal input, analog (Input X1)		
Type	Range (over range)	Resolution
AI (LG-)Ni1000		55 mK 0.099 °F
AI PT1K 385 (EU)	-40...150 °C (-45...160 °C) -40...302 °F (-49...320 °F)	85 mK 0.153 °F
AI Ni1000 DIN		45 mK 0.081 °F
AI NTC10K	-35...110 °C (-40...115 °C) -31...230 °F (-40...239 °F)	20 mK (25 °C) 0.036 °F (77 °F)
AI NTC100K	-35...120 °C (-40...125 °C) -31...248 °F (-40...257 °F)	20 mK (25 °C) 0.036 °F (77 °F)

Position feedback, analog (Input U)			
Type	Range (over range)	Resolution	Input resistance (R _I)
AI 0...10 V	0...10 V (-1...11 V)	1 mV	100 kΩ
Open connection: Negative voltage -3.1 V (line failure detection)			

Temperature measurement for power measurement, analog (Inputs B7, B26)		
Type	Range (over range)	Resolution
AI PT1K 385 (EU)	-40...150 °C (-45...160 °C) -40...302 °F (-49...320 °F)	85 mK 0.153 °F

Temperature and voltage measurement, analog (Input X3)			CURRENTLY NOT IN USE
Type	Range (over range)	Resolution	
AI PT1K 385 (EU)		85 mK 0.153 °F	
AI (LG-)Ni1000	-40...150 °C (-45...160 °C) -40...302 °F (-49...320 °F)	55 mK 0.099 °F	
AI Ni1000 DIN		45 mK 0.081 °F	
AI NTC10K	-35...110 °C (-40...115 °C) -31...230 °F (-40...239 °F)	20 mK (25 °C) 0.036 °F (77 °F)	
AI NTC100K	-35...120 °C (-40...125 °C) -31...248 °F (-40...257 °F)	20 mK (25 °C) 0.036 °F (77 °F)	
AI 0...10 V	0...10 V (-1...11 V)	1 mV	100 kΩ
AI 0...10 V standard	0...100% (-10...110%)	1 mV	
Open connection: Negative voltage -1.5 V, 8 μA (line failure detection)			

Flow measurement, digital (Input DU)
Use only the flow sensors specified in the data sheet.

Outputs

The outputs are protected against short circuiting and incorrect wiring AC/DC 24 V.

Position feedback, analog (output X2)			
Type	Range (over range)	Resolution	Output current / output impedance
AO 0-10 V	0...10 V (0...10.5 V)	11 mV	Max. 1 mA
AI 4...20 mA	4...20 mA (4...20 mA)	22 µA	<650 Ω

Signal output, analog (Output Y)			
Type	Range (over range)	Resolution	Output current
AO 0-10 V	0...10 V (0...10.5 V)	11 mV	Max. 1 mA

Switching outputs relay (Outputs Q13, Q14)		CURRENTLY NOT IN USE
Type	Relay	
Switching voltage	AC 24 V / DC 30 V	
Permissible load current	100 mA	

Supply for field devices (outputs V-)	
Output voltage	AC / DC 24 V
Permissible load current	10 A
Protection against overload	None

Conformity

Protection class	
Housing protective class from vertical to horizontal (see 'Mounting', page 14)	IP 54 as per EN 60529
Insulation class	As per EN 60730
AC / DC 24 V	III

Ambient conditions	
Operation	as per EN 60721-3-3
Climatic conditions	Class 3K5
Mounting location	Indoors (weather-protected)
Temperature (general)	-5...< 55 °C
Humidity (non-condensing)	5...95% r.h.
Transport	as per EN 60721-3-2
Climatic conditions	Class 2K3
Temperature	-25...70 °C
Humidity	< 95% r.h.
Storage	Per IEC 60721-3-1
Climatic conditions	Class 1K5
Temperature	-5...55 °C
Humidity	5...95% r.h.
Max. media temperature when mounted on valve	120 °C



Directives and standards	
Product standards	EN 60730-x
Electromagnetic compatibility (field of use)	For residential, commercial, and industrial environments
EU conformity (CE)	
EVG.. / EVF..	A6V11692721 ¹⁾
ASE4U10E	A6V11664685 ¹⁾
AVG4E..VAG / AVF4E..	A6V11692707 ¹⁾
GLA161.9E/HR	A6V101082021 ¹⁾
SAV61.00/HR	A6V10455624 ¹⁾
SAX61.03/HR	A6V10321559 ¹⁾
EZU10-..	A6V11692688 ¹⁾
RCM Conformity	
EVG.. / EVF..	A6V11694334 ¹⁾
ASE4U10E	A6V11692702 ¹⁾
AVG4E..VAG / AVF4E..	A6V11692730 ¹⁾
GLA161.9E/HR	A6V101082027 ¹⁾
SAV61.00/HR	A6V10455626 ¹⁾
SAX61.03/HR	A6V10402431 ¹⁾
EAC compliance	Eurasian compliance for all EVG../EVF..

Environmental compatibility	
The product environmental declarations listed below contain data on environmentally compatible product design and assessments (RoHS compliance, material composition, packaging, environmental benefit, and disposal).	
ASE4U10E	A6V11684717 ¹⁾
AVG4E..VAG	A6V11654066 ¹⁾
AVF4E..	A6V11654064 ¹⁾
ALF4E..	A6V11654081 ¹⁾
EZU10-..	A6V11684742 ¹⁾
GLA161.9E/HR	A6V101033533 ¹⁾
SAV61.00/HR	A6V10450170 ¹⁾
SAX61.03/HR	A6V10691442 ¹⁾
VVF42..KC	A6V10824366 ¹⁾
EZT..	A6V11684744 ¹⁾
EZU-WA	A6V11654200 ¹⁾

¹⁾ Documents can be downloaded at <http://www.siemens.com/bt/download>.

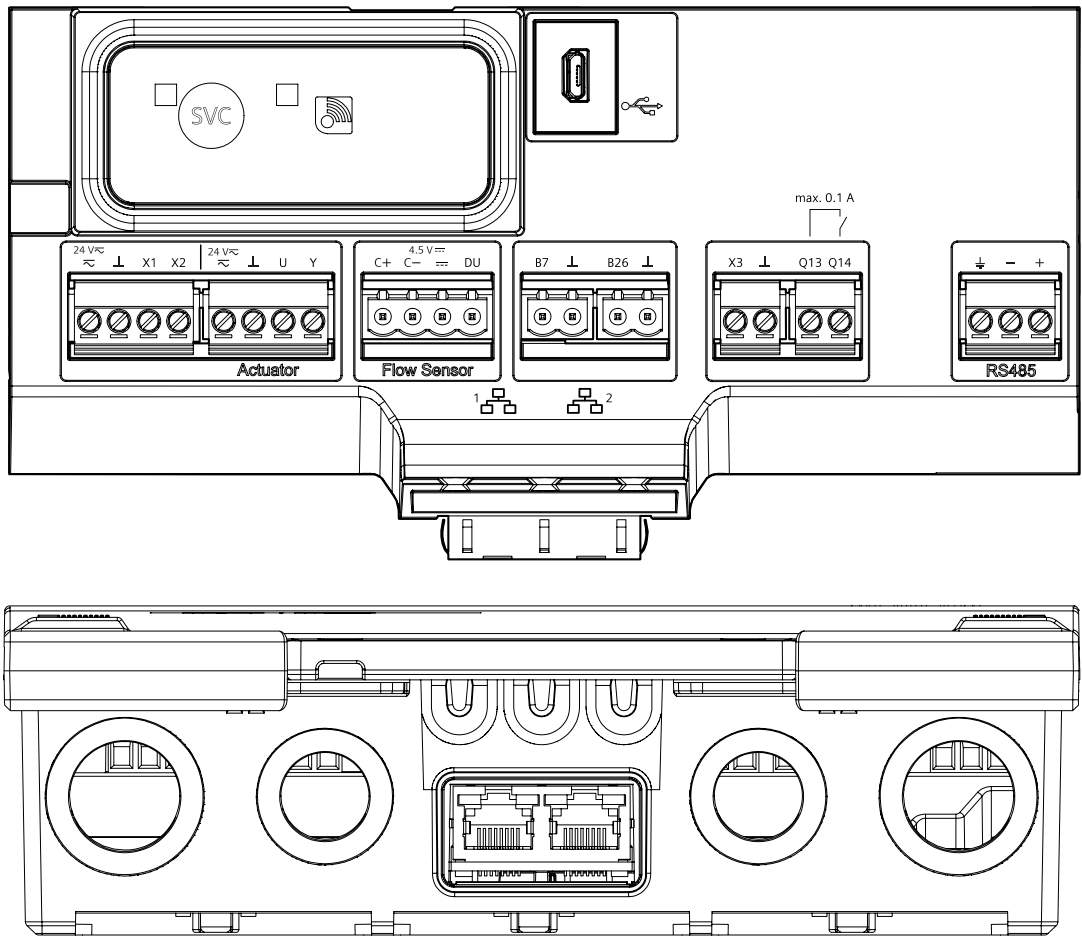
Connection terminals



Connecting thread	Description	Terminal
1, 2 Ethernet	2 x RJ45 interface for 2-port Ethernet switch	
	Power SELV/PELV AC/DC 24 V	V-
	System zero	⊥
	Setpoint input Intelligent Valve: DC 0/2...10 V; 4...20 mA	X1
	Actual value output for Intelligent Valve: DC 0/2...10 V; 4...20 mA	X2
USB	USB interface	
Actuator	Field supply AC 24 V for actuator	V-
	System zero	⊥
	Position feedback actuator DC 0...10 V	U
	Positioning signal actuator DC 0...10 V	Y
Flow sensor	L-bus potential	C+
	L-bus neutral (Galvanically insulated)	C-
	Power flow sensor (DC 4.5 V)	=
	Pulse input	DU
Analog inputs	Passive temperature input	B7
	System zero	⊥
	Passive temperature input	B26
	System zero	⊥
	Currently not in use	X3
		⊥
	Currently not in use	Q13
		Q14
RS 485	Currently not in use	↓
		-
		+
Service	Service button	SVC
Display	Operation LED	
Com/ WLAN	WLAN button	
Display	Communication LED	

Intelligent Valve controller, ASE4U10E

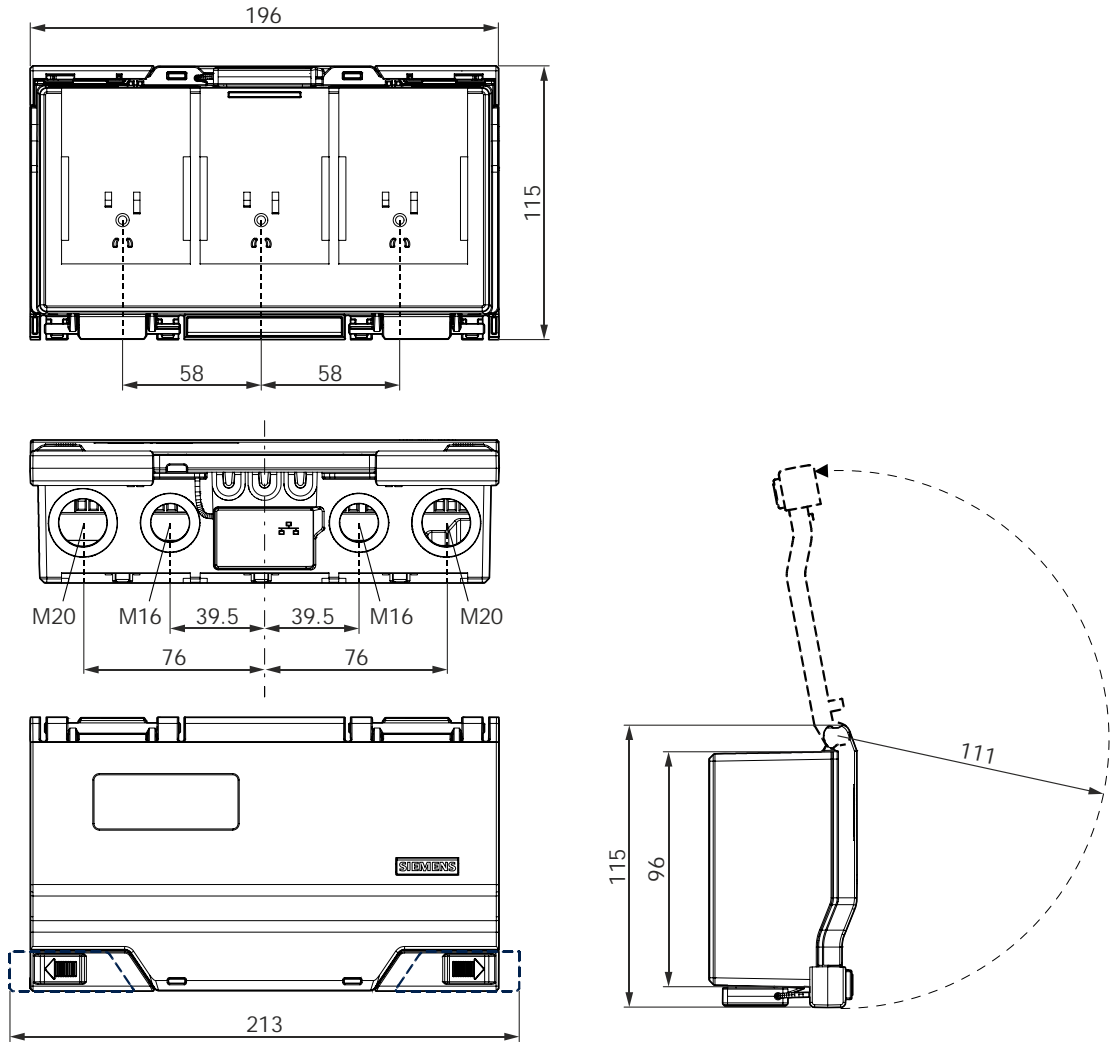

Dimensions in mm

kg
0,5

With threaded connection, EVG4U10E..

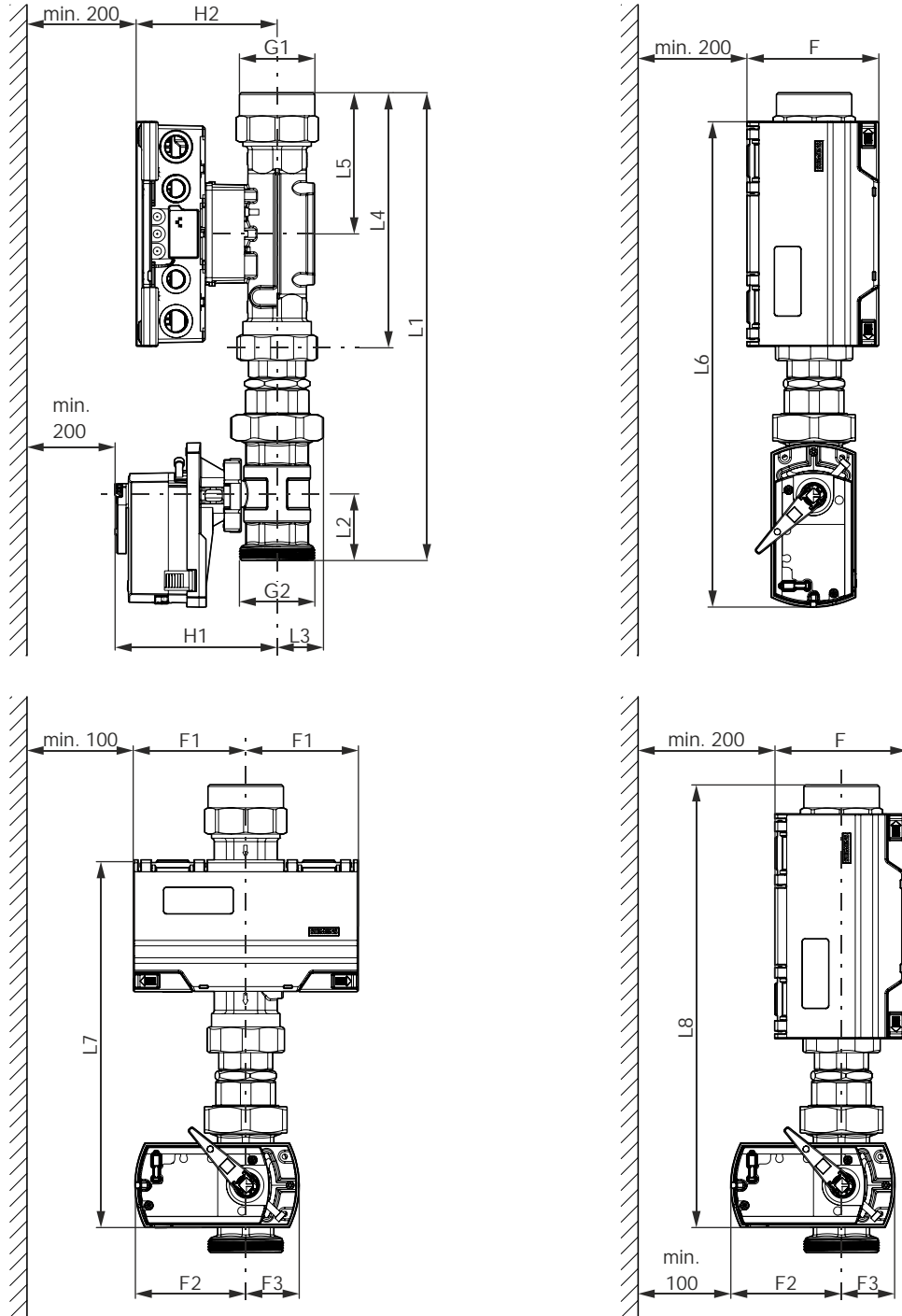

Valve type	F	F1	F2	F3	G 1	G 2	H1	H2	L1	L2	L3	L4	L5	L6	L7	L8	kg
EVG4U10E015	115	98	98	46	G 1 B	130	110	232	43.5	21.5	115	60	382	-	321	2.9	
EVG4U10E020					G 1¼ B	130	112	274	45	28.5	130	65	360		300	3	
EVG4U10E025					G 1½ B	132.5	116	302	29	150	75	377	317		3.7		
EVG4U10E032					G 2 B	136	250	50	35	145	77.5	380	320		4		
EVG4U10E040					G 2¼ B	142	408	58	40.5	223	123	423	324	6.6			
EVG4U10E050					G 2¾ B	155	356	62.5	49	223	123	367	367	7.6			

1) Arrangement not possible

Dimensions in mm

Flanged, EVF4U20E..

DN 65...100

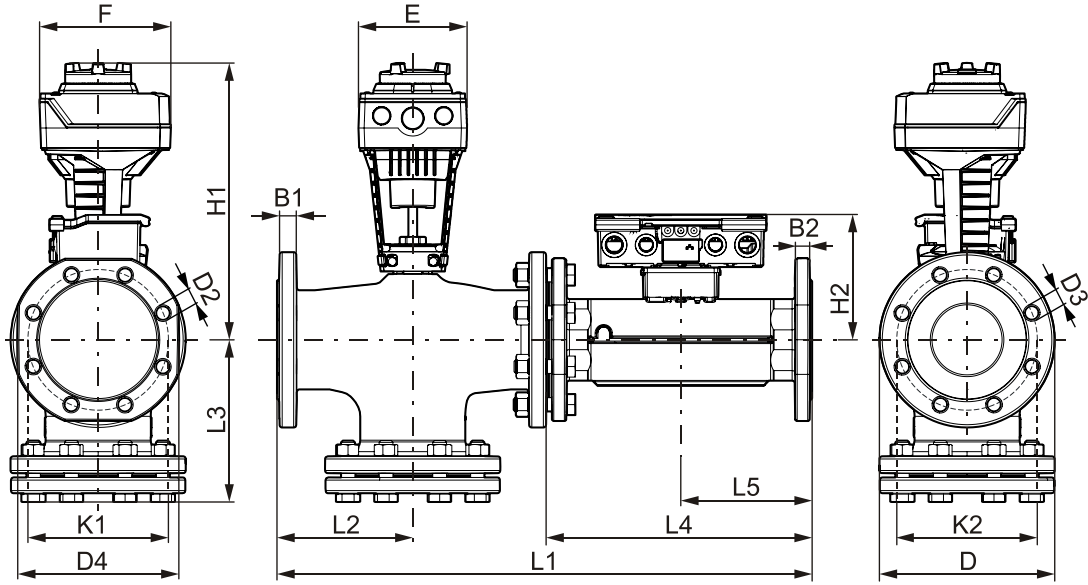

DN 125

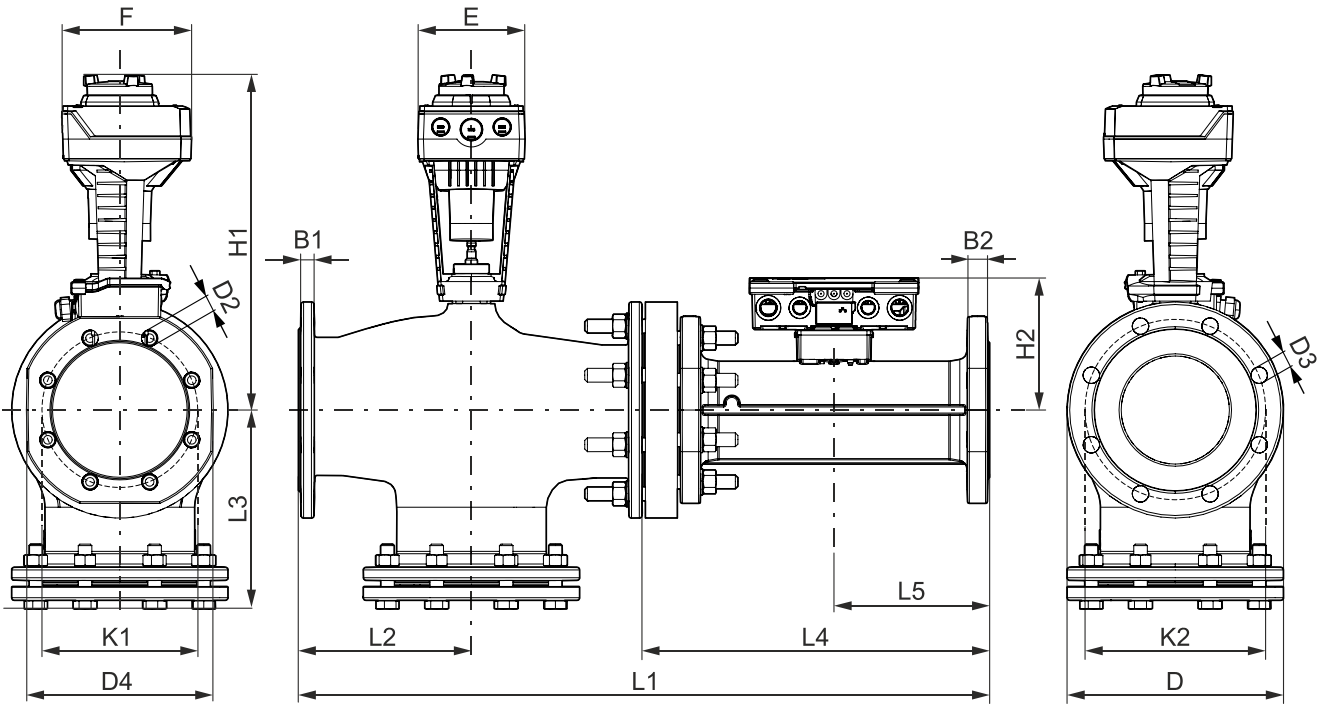

Valve type	B1	B2	D	D2	D3	D4	E	F	H1	H2	K1	K2	L1	L2	L3	L4	L5	kg
EVF4U20E065	17	19	184	18 (4x)	19 (4x)	170	124	150	316	136	145	145	591	145	174	300	150	28.2
EVF4U20E080	19	18	200	19 (8x)	19 (8x)	185				143	160	160	611	155	186			41.1
EVF4U20E100	20	23	220	19 (8x)		216			375	154	180	711	175	206	360	180	56.9	
EVF4U20E125	15		250		388	800			200			228	69.6					

Dimensions in mm

Temperature sensors EZU., protection pockets EZT..

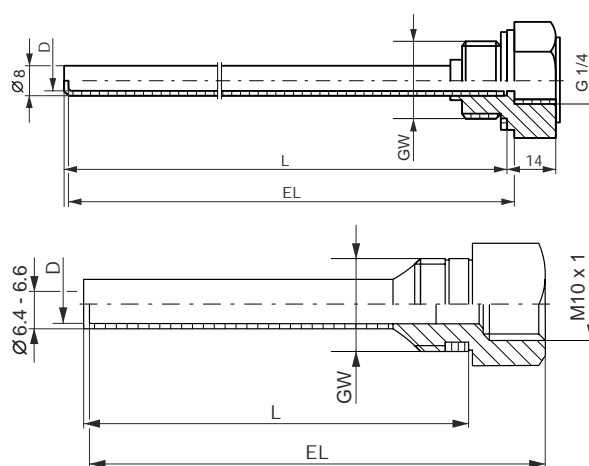
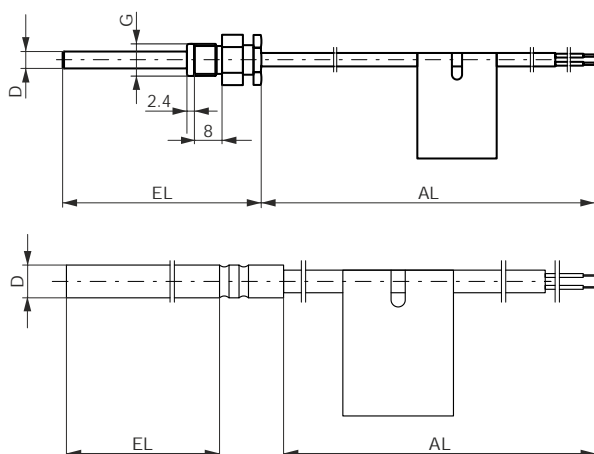

Temperature sensors				
Type	D	EL	G	AL
EZU10-2615	5.2	26.5	M10 x 1	1500
EZU10-10025	6	92.5	-	2500

Protection pockets				
Type	D	EL	L	GW
EZT-M40	5.4	40	-	-
EZT-S100	6.2	100	92,5	G ½

Dimensions in mm

Revision numbers

Type	Valid from rev. no.	Type	Valid from rev. no.
EVG4U10E015 S55300-M100	..A	EVF4U20E065 S55300-M106	..A
EVG4U10E020 S55300-M101	..A	EVF4U20E080 S55300-M107	..A
EVG4U10E025 S55300-M102	..A	EVF4U20E100 S55300-M108	..A
EVG4U10E032 S55300-M103	..A	EVF4U20E125 S55300-M109	..A
EVG4U10E040 S55300-M104	..A		
EVG4U10E050 S55300-M105	..A		

Issued by
Siemens Switzerland Ltd
Smart Infrastructure
Global Headquarters
Theilerstrasse 1a
CH-6300 Zug
Tel. +41 58 724 2424
www.siemens.com/buildingtechnologies

© Siemens Switzerland Ltd, 2019
Technical specifications and availability subject to change without notice.