



ExBin-P... pressure switch from 25 Pa...5.000 Pa

ExBin - P...

ExBin - P... - 2

Subject to change!

Electrical, explosion proof pressure or differential pressure switch

24 VAC/DC supply voltage, output potential free switching contact

PTB-certified in acc. with ATEX directive 94/9/EC for zone 1, 2, 21, 22 in preparation

Compact . Easy installation . Universal . Cost effective . Safe

Type	Sensor	Supply	Range	Min. setting	Max. pressure	Output switch	Max. ratings	Wiring
ExBin - P500	Pressure-/Diff. press.	24 VAC/DC	500 Pa	25 Pa	5.000 Pa	pot. free contact	250 VAC, 0.1A / 30 V, 0.5 A	SB 1.0
ExBin - P5000	Pressure-/Diff. press.	24 VAC/DC	5.000 Pa	250 Pa	50.000 Pa	pot. free contact	250 VAC, 0.1A / 30 V, 0.5 A	SB 1.0
ExBin - P... - 2	as above, but with second switching output					2 pot. free contacts	250 VAC, 0.1A / 30 V, 0.5 A	SB 1.0

Application

Pressure or differential pressure switch

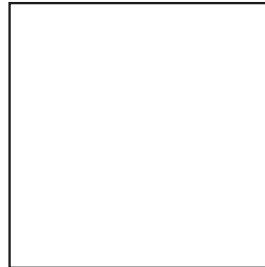
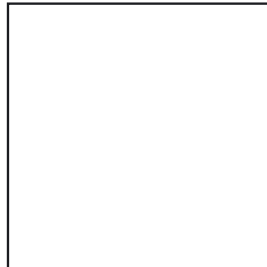

Description

The new **ExBin-P...** pressure switch generation from 25 Pa to 5.000 Pa (acc. to type) is a revolution for differential pressure switches in HVAC systems, in chemical, pharmaceutical, industrial and Offshore-/Onshore plants, for use in hazardous areas zone 1, 2 (gas) and zone 21, 22 (dust).

Highest protection class (ATEX) and IP 66 protection, small dimension, universal functions and technical data guarantee safe operation even under difficult environmental conditions.

The switching points are scalable within the maximum ranges. The integrated display is for actual value indication which can be switched off. All sensors are programmable on site without any additional tools.

ExBin-P...-2 sensors are additionally equipped with a secondary switching output, which can be parameterized independently.

Highlights

- ▶ For all type of gas, mixtures, vapours and dust for use in zone 1, 2, 21 and 22
- ▶ No additionally Ex-i module required
- ▶ No intrinsically safe wiring/installation between panel and sensor required
- ▶ No intrinsically safe wiring/installation and no space in the panel required
- ▶ Integrated Ex-e junction box
- ▶ Power supply 24 VAC/DC
- ▶ Output potential free switching contact
- ▶ Display with backlight, can be switched off
- ▶ Scalable switching characteristics
- ▶ Scalable starting bypass time
- ▶ Compact design and small dimension (L x B x H = 177 x 107 x 66 mm)
- ▶ Robust aluminium housing in protection class IP 66
- ▶ Down to -20°C ambient temperature applicable
- ▶ Password locking
- ▶ Optional second switching output



Technical data	ExBin - P...
Power supply	24 VAC/DC \pm 20% (19,2...28,8 VAC/DC) 50...60 Hz
Current, power consumption	120 mA, ~ 2,5 W, internal fuse 500 mA, without bracket, not removable
Galvanic isolation	Supply – output 1,5 kV
Electrical connection	Terminals 0,14...2,5 mm ² at integrated Ex e junction box
Cable entry	2 x M16 x 1,5 Ex e approved, cable diameter ~ \varnothing 5...10 mm
Protection class	Class I (grounded)
Display	LCD with backlight, display for configuration, user guidance, parameter and actual value indication via LEDs
Control elements	3 buttons for configuration
Housing protection	IP66 in acc. to IEC 60529
Housing material	Aluminium casting, coated
Dimension / weight	L x W x H = 177 x 107 x 66 mm / ~ 950 g
Ambient temperature/-humidity	- 20...+ 50 °C / 0...95 % rH, non condensed
Storage temperature	- 40...+ 70 °C
Measuring range	0...500 Pa, 0...5.000 Pa in acc. to type
Range scalable on site	Minimum measuring range is 5 % of full range
Maintenance	Maintenance free, nevertheless maintenance must be complied with regional standards, rules and regulations
Sensor circuit	Internal „IS“ circuit
Sensor	Piezo-pressure-transmitter
Pressure connection	P+ / P- sleeves \varnothing 4...6 mm
Response time of sensor	T90 / 5 sec.
Accuracy of pressure	\pm 5 % of end value \pm 1 Pa
Setting range hysteresis	ExBin-P500: 0,5 Pa...50,0 Pa (factory setting 10,0 Pa) ExBin-P5000: 5,0 Pa...500,0 Pa (factory setting 100,0 Pa)
Start delay	5 sec.
Starting bypass time	3...240 sec. (via menu adjustable; preset 120 sec.)
Setting zero point	Via menu, mechanical short circuit of P+ / P- for the moment of zero point setting
Output switch	Potential free switching contact
Ratings load max.	0,5 A @ 24 VAC/DC / 0,1 A @ 250 VAC / 0,1 A @ 220 VDC
Ratings load min.	10 mW / 0,1 V / 1 mA
Mechanical life	10×10^6
Electrical life (rated load)	100×10^3
Wiring diagram (SB)	SB 1.0
Installation sensor / tubing	In Ex-area zone 1, 2, 21, 22

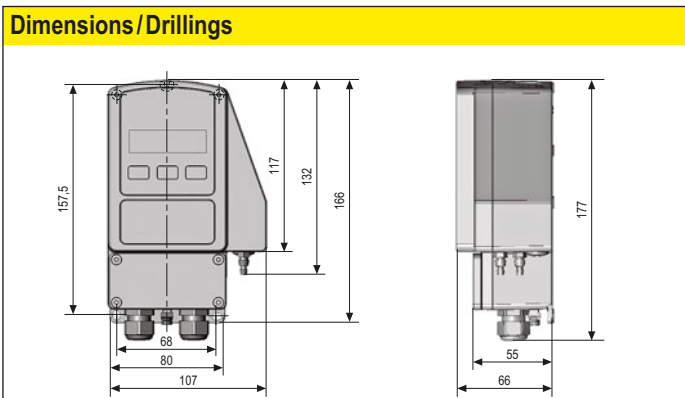

Explosion proof		
PTB-testet	PTB 09 ATEX 2011	94/9/EC (ATEX)
Approval for gas	II2(1)G Ex emb[ia] IIC T6	for zone 1, 2
Approval for dust	II2(1)D Ex tD A21 [iaD] IP66 T80°C	for zone 21, 22
CE-Mark	CE No. 0158	
EMC directive	RL 89/336/EC	
Low voltage directive	RL 73/23/EC	
Protection type	IP 66 in acc. to EN 60529	
Potential compensation	external PA-terminal, 4 mm ²	
Protection Class	I (grounded)	

Accessories	
MKR	Mounting bracket for round ducts up to \varnothing 600 mm
Kit 2	consists of 2 m flexible pressure tube \varnothing 6 mm, 2 connection nipples

Electrical connection

ExBin-P... switches are equipped with a 24 VAC/DC power supply. The supply has to be connected at terminal 1 (-/~) and 2 (+/~). The electrical wiring must be realized via integrated Ex-e junction box in acc. to ATEX. Type of protection for the terminals is „Ex-e“. If supply voltage 24 VAC/DC different from the relay voltage must be used different or double isolated cables. The starting bypass delay can be activated by a short circuit of terminal 2 and terminal 3 (AUB). An active bypass delay is indicated with green blinking LEDs.

Attention: Do not open covers when circuits alive!

Wiring Diagram ExBin-P... / ExBin-P...-2

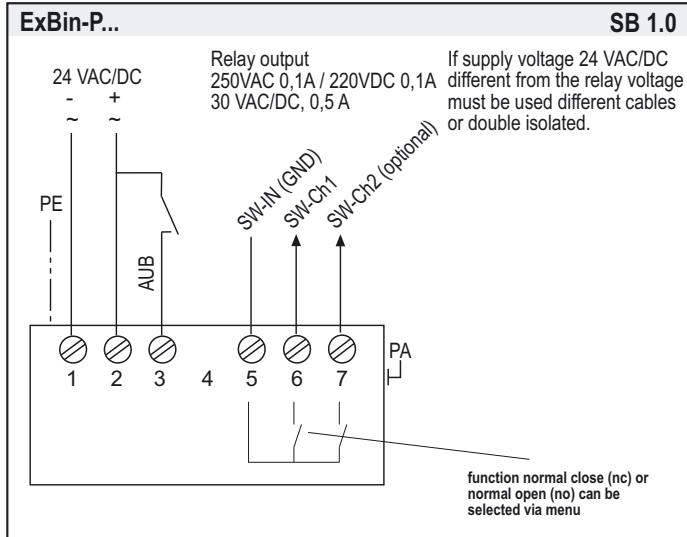

Zero point compensation for pressure transmitter

ExBin-P... pressure switch is equipped with a zero point compensation, to adjust the module to the installation position. The pressure nipples **P+** / **P-** must be connected with a short circuit tube. To make compensation please follow the menu 14. In menu zero point compensation is done by push the enter button. Before starting the zero point compensation, the device should be connected to the power supply for minimum of 15 minutes, to reach the working temperature!

Display and Buttons

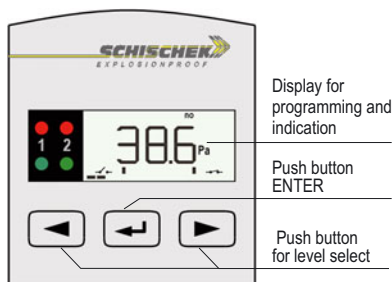

Change operation-/parametrisation mode

To change from operation to parametrisation mode push the enter button for minimum 3 seconds. Back over the menu save.

Indication of data logging

A blinking unit in the display shows that datas received and the device is working.

Password input

The default / delivery setup is **0000**. In this configuration the password input is not activated. To activate a password change the 4 digits into your choosen numbers (e.g. 1234) and press Enter.

Please keep your password in mind for next parameter change!

Due to a new parameter setup the password is requested.

Installation

Ex area Zone 1, 2, 21, 22			safe area
------------------------------	--	--	-----------

- Nevertheless maintenace must comply with regional standards, rules and regulations.
- Do not open covers when circuits alive.
- For electrical connection use the integrated junction box Ex-e.
- The cable must be installed in a fixed position and protected against mechanical and thermal damage.
- Connect protection earth.
- Avoid thermal transfer from sensor to transducer (ensure max ambient temperature !).
- Ambient temperature - 20...+ 50 °C
- Close all covers, entries with min IP66.
- All transducers are maintenance free.
- For outdoor installation a protective housing against rain, snow and sun should be applied.
- Only wet cleaning.

Important information for installation and operation

Installation, Commisioning, Maintenance

The cable has to be drawn through the cable gland. After electrical connection the cable gland must be fixed tighten. IP66 must be fulfilled. In acc. with operation ExBin switches are maintenance free. Nevertheless maintenace must comply with regional standards, rules and regulations. The sensors must not be opened by the customer. For outdoor installation a protective housing against rain, snow and sun should be applied. For electrical connection use the internal approved Ex-e junction box.

Attention: Note the explosion proof rules before opening the internal junction box. Cut off the power supply.

A. Supply and Contact

Wires from safety extra low voltage must be separated from others. Only at 24 VAC/DC is supply and signal wires in one cable permitted. All others use separate or double isolated cables. Install overload protection fuse < 10 A.

B. Pressure sensors

After mounting and installation, a zero point compensation must be done, because the offset value depends on the installation position. Have a look to parametrisation.

C. Long cabling

For using long signal wires, shielded cables are recommended. The shield must be connected to the ExBin-P switch inside the terminal box.

D. Separate ground wires

Use for supply and signal wires a separate ground.

Parametrisation and commissioning of ExBin-P transducers

Preparation of parametrisation/operation

































































Operation ↔ Parametrisation, push  for 3 sec.

If password (PW) protection is active: put PW in, push 



Change operation-/parametrisation mode

To change from operation to parametrisation mode push „enter button“  for minimum 3 seconds. Back over the menu save.

Menu	Function	Enter	Indication	Select	Enter	Next indication	Next selction	Enter	Next menu
Menu 1	Preset select application	 PSEt 	Menu 1 PRO	  					
Menu 2	unit sensor 1 select physical unit	 Un it 	Menu 2 Pa	  		Pa, mBar, lnH ₂ O			
Menu 3	set 1 select switching point 1	 SEt 1 	Menu 3 2000 Pa	  		adjust set 1			
Menu 4	set 2* select switching point 2	 SEt 2 	Menu 4 4000 Pa	  		adjust set 2			
Menu 5	hysteresis** select physical unit	 HYS t 	Menu 5 100 Pa	  		adjust hysteresis			
Menu 6	mode** select switching characteristic	 ModE 	Menu 6 UP	  		norm. open (no), norm. closed (nc)	Menu 6 nc	  	
Menu 7	no function – menu skip								
Menu 8	no function – menu skip								
Menu 9	no function – menu skip								
Menu 10	no function – menu skip								
Menu 11	no function – menu skip								
Menu 12	time select time for starting bypass (AUB)	 T IME 	Menu 12 100	  		adjust bypass time			
Menu 13	lamp select backlight	 LAMP 	Menu 13 ON	  		on, off			
Menu 14	zero point compensation	 0-Pt 	Menu 14 FUN						
Menu 15	security select password	 SECU 	Menu 15 0000	  		enter password			
Menu 16	save select save data	 SAVE 	Menu 15 YES	  		no, yes, return, default setting			

* available for 2-stage version only (ExBin-P...-2)

** useable in professional mode only (see Menu 1 – professional mode)

Using the menu 1 „Preset“

To beware complexity during the parametrisation process, the ExBin-P has several predefined setups, which distinguish between its intended application. You'll find a detailed description of all possible presets in the following section.

Fan speed monitoring

The preset „FAN“ is designed for use in fan speed monitoring applications.



Menu1: Select "FAN" and press the enter button.

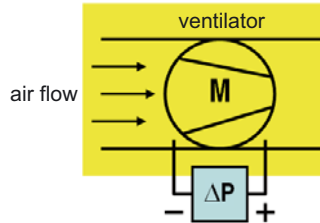

If the „FAN“-preset has been selected in menu 1, all settings were made as the following ones:

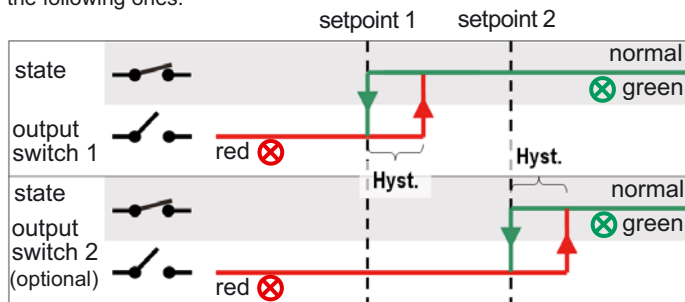

The user has not to set the menu 5 „hysteresis“ and menu 6 „mode“, this will be done via software. These menus will be skipped during the further parametrisation process.

Filter monitoring

The preset „FILT“ is designed for use in filter monitoring applications.



Menu1: Select „FILT“ and press the enter button.

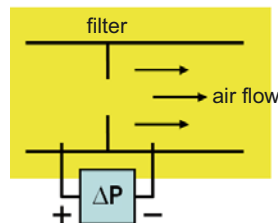

If the „FILT“-preset has been selected in menu 1, all settings were made as the following ones:

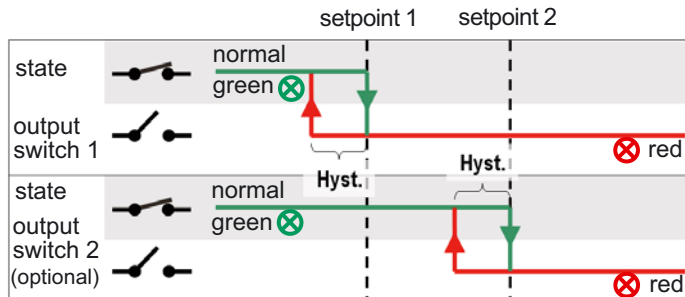

The user has not to set the menu 5 „hysteresis“ and menu 6 „mode“, this will be done via software. These menus will be skipped during the further parametrisation process.

Professional mode

For all other applications the professional mode is designed for.



Menu1: Select „PRO“ and press the enter button.

If the „PRO“-preset has been selected in menu 1, the parametrisation procedure will be added by two further menus: menu 5 „hysteresis“ and menu 6 „mode“. For this preset the user has to select the values for the hysteresis and for the mode.

Using the menu 6 „mode“

First of all the user has to define the device normal range. For example:

- The device should indicate (green LED) if the pressure is under the setpoints, mode „down-range“ has to be selected. With other words: the measure value is normally under the setpoints.
 - The device should indicate (green LED) if the pressure is over the setpoints, mode „up-range“ has to be selected. (The measure value is normally over the setpoints.)
 - The device should indicate (green LED) if the pressure is between the setpoints, mode „mid-range“ has to be selected. (The measure value is normally between the setpoints.) This mode is only for 2-stage devices available (ExBin-P...-2).
- In the second step the switching characteristic of the output relay has to be selected:
- „normally closed“ (nc): if the measure value is in the normal range (see above), the corresponding relays were closed.
 - „normally open“ (no): if the measure value is in the normal range (see above), the corresponding relays were open.

You'll find a detailed description of all possible settings in the following section.

Switching characteristic „up-range“ – „normally closed“

„Up-range“: the normal range is above setpoint 1 and setpoint 2

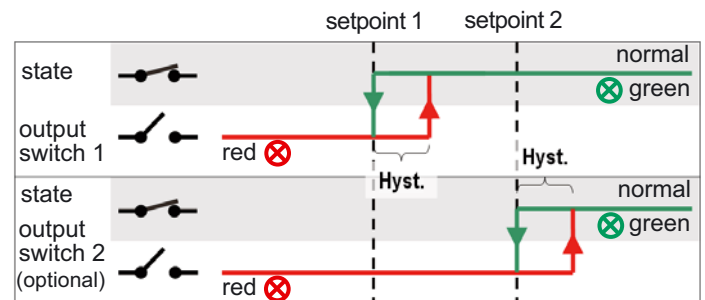

Switching characteristic „up-range“ – „normally open“

„Up-range“: the normal range is above setpoint 1 and setpoint 2

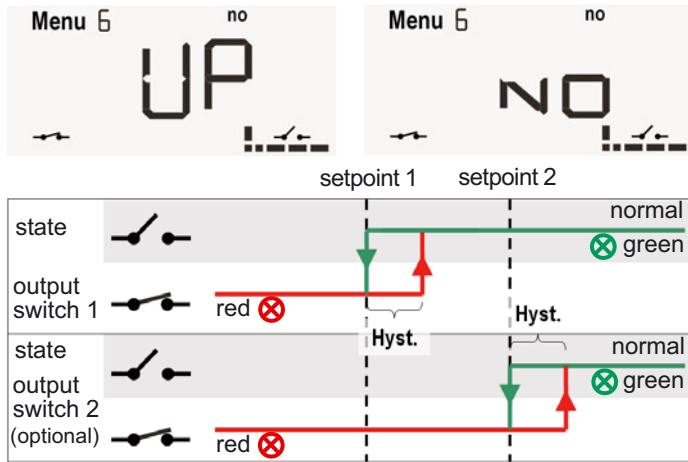

Switching characteristic „down-range“ – „normally closed“

„Mid-range“: the normal range is under setpoint 1 and setpoint 2

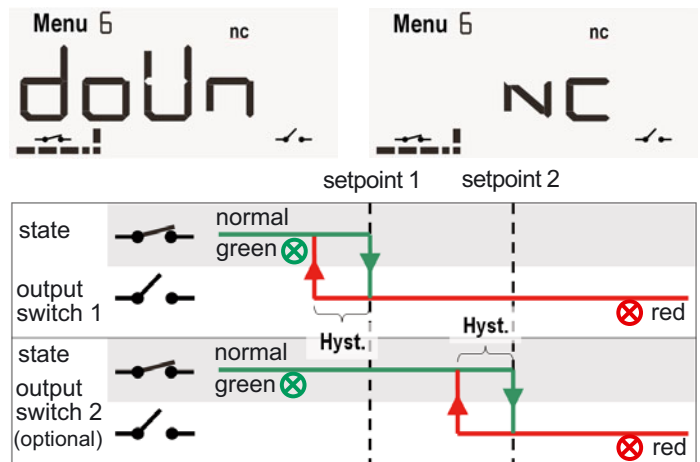

Switching characteristic „mid-range“ – „normally closed“

„Mid-range“: the normal range is between setpoint 1 and setpoint 2 (for 2-stage devices only)

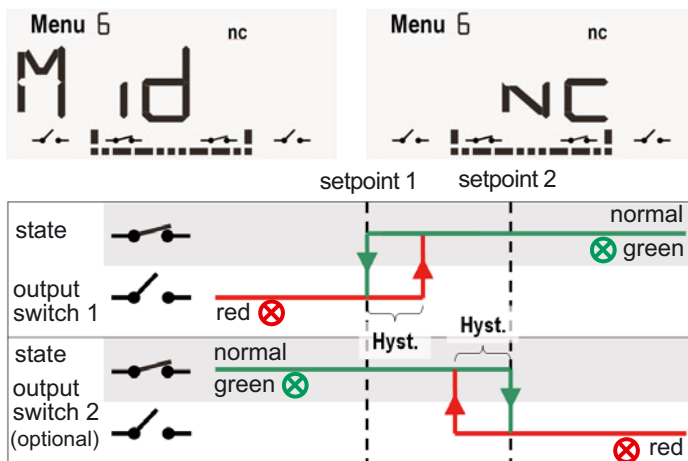

Switching characteristic „down-range“ – „normally closed“

„Mid-range“: the normal range is under setpoint 1 and setpoint 2

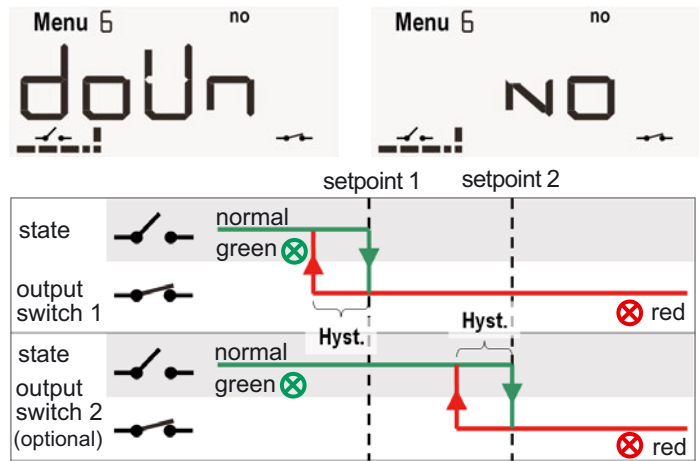

Switching characteristic „mid-range“ – „normally open“

„Mid-range“: the normal range is between setpoint 1 and setpoint 2 (for 2-stage devices only)

