



ACVATIX™

Modulating control valves MXG461S.. with magnetic actuator, PN 16

stainless steel

-
- Fast positioning time (<2 s), high-resolution stroke (1 : 1000)
 - Selectable valve characteristic: equal-percentage or linear
 - High rangeability
 - Operating voltage AC/ DC 24 V
 - Switch-selected control signal DC 0/2...10 V or DC 4...20 mA
 - Wear-free inductive stroke measurement
 - Robust, no maintenance required
 - Spring-return function: A → AB closed when de-energized
 - Positioning control, position feedback and manual control
 - Parts in contact with medium in CrNi steel
 - Applications with demineralized water upon request

Use

The control valves MXG461S.. are mixing or through-port valves. They are supplied with the magnetic actuator ready fitted, equipped with an electronics module for position control and position feedback. The short positioning time, high resolution and high rangeability make these valves ideal for modulating control of open and closed circuits with the highest control requirements.

Type summary

Type reference	DN	Connection [inch]	k _{vs} [m ³ /h]	Δp _{max} [kPa]	Δp _s [kPa]	Operating voltage	Positioning		Spring return function
							signal	time	
MXG461S15-1.5	15	G 1B	1.5	300	300	AC / DC 24 V	DC 0...10 V or DC 2...10 V or DC 4...20 mA	<2 s	✓
MXG461S20-5.0	20	G 1¼B	5.0						
MXG461S25-8.0	25	G 1½B	8.0						
MXG461S32-12	32	G 2B	12						

DN = Nominal size.

k_{vs} = Nominal flow rate of cold water (5 to 30 °C) through the fully opened valve (H₁₀₀) at a differential pressure of 100 kPa (1 bar).

Δp_{max} = Maximum permissible differential pressure across the valve's control path, valid for the entire actuating range of the motorized valve (mixing: path A-AB, B-AB)

Δp_s = Maximum permissible differential pressure at which the motorized valve will close securely against the pressure (close off pressure).

Accessory

Type reference	Description
SEZ91.6	External interface for DC 0...20 V phase cut control signal, refer to data sheet N5143

Ordering

Valve body and magnetic actuator form one assembly and cannot be separated.

When placing an order, please specify the quantity, product description and type code.

Example:

Type reference	Stock number	Description	Quantity
MXG461S25-8.0	MXG461S25-8.0	Modulating control valve with magnetic actuator	2

Delivery

A CrNi-Stahl seal disc with 3 gaskets is part of the delivery.

Union fittings must be supplied by the installer.

Rev. no.

Overview table, see page 12.

Replacement electronics module ASE1

Should the valve electronics prove faulty, the electronics module must be replaced by the ASE1 replacement electronics module. Mounting instruction no. 35678 is included.

Technical and mechanical design

For a detailed description of operation, refer to data sheet CA1N4028E.

Control operation

The electronics module converts the positioning signal to a phase-cut power signal which generates a magnetic field in the coil. This causes the armature to change its position in accordance with the interacting forces (magnetic field, counter spring, hydraulics). The armature responds rapidly to any change in signal, transferring the corresponding movement directly to the valve plug, enabling fast changes in load to be corrected quickly and accurately.

The valve's position is measured continuously (inductive). The internal positioning controller balances any disturbance in the system rapidly and delivers the position feedback signal. The valve stroke is proportional to the positioning signal.

Control

The magnetic actuator can be driven by a Siemens controller or a controller of other manufacture that deliver a DC 0...10 V, DC 2...10 V or DC 4...20 mA output signal. To achieve optimum control performance, it is recommended to use a 4-wire connection.

Spring return function

If the positioning signal is interrupted, or in the event of a power failure, the valve's return spring will automatically close control path A → AB.

Manual control

MANUAL

The valve control path (ports A → AB) can be opened manually to between 80...90 % of the full stroke (depending on DN) by pressing the hand wheel inwards and turning it clockwise (MANUAL setting). This disables the control signal from the controller, the green LED is flashing.

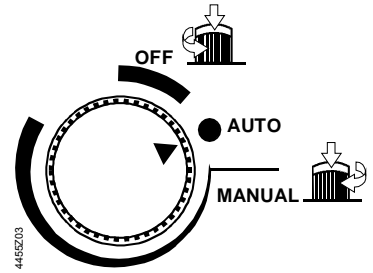

OFF

To disable automatic control of the valve, press the hand wheel inwards and turn it anti-clockwise (to the OFF position). The valve will close, the green LED is flashing.

AUTO

For automatic control, the hand wheel must be set to the AUTO position (the hand wheel will spring out), the green LED is lit.

Operator controls and indicators in the electronics housing

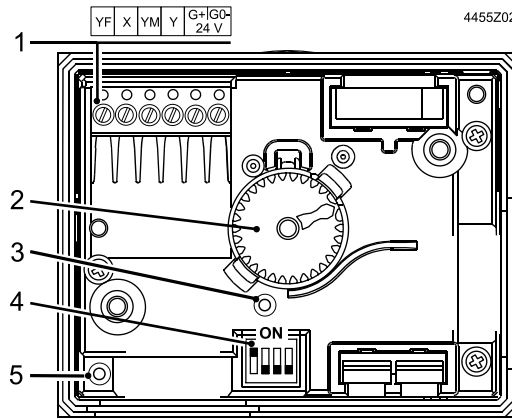

- 1 Connection terminals
- 2 Hand wheel
- 3 Opening for auto calibration
- 4 DIL switch for mode control

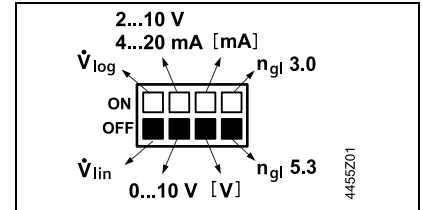

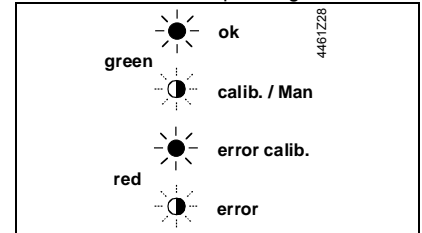

- 5 LED for indication of operating stat



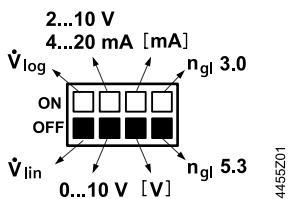

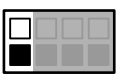
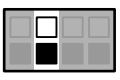
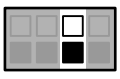





Configuration DIL switch



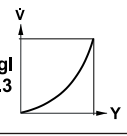
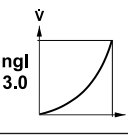

Switch	Function	ON / OFF	Description
1  4455Z05	Valve characteristic	ON	\dot{V}_{log} (equal percentage)
		OFF	\dot{V}_{lin} (linear) ¹⁾
2  4455Z06	Positioning signal Y	ON	DC 2...10 V, DC 4...20 mA
		OFF	DC 0...10 V ¹⁾
3  4455Z07	[V] or [mA]	ON	[mA]
		OFF	[V] ¹⁾
4  4455Z15	Valve characteristics	ON	n _{gl} 3.0
		OFF	n _{gl} 5.3 ¹⁾

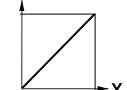
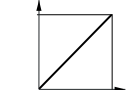
¹⁾ Factory setting

Selection of positioning signal Y: Voltage or current			Selection of valve characteristic (Positioning signal against volumetric flow): Equal-percentage or linear		
 Y	ON 	ON 			
ON 	0...10 V	2...10 V	ngl 5.3 	ngl 3.0 	
ON 		4...20 mA			
					4455Z08

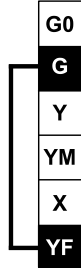
Forced control input

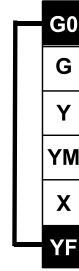
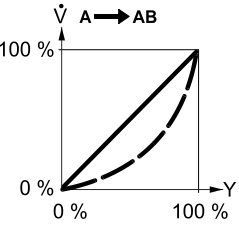
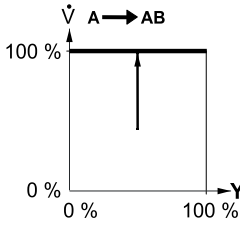
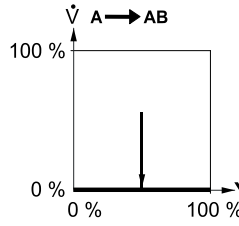
		YF – Function		
		no function	fully open	closed
Connection				
				
Transfer				
Function		<ul style="list-style-type: none"> • YF not wired • Valve follows Y signal 	<ul style="list-style-type: none"> • YF connected with G • Valve fully opens above A → AB 	<ul style="list-style-type: none"> • YF connected with G0 • Valve closes above A → AB

Signal priority

1. Hand wheel position MANUAL (open) or OFF (closed)
2. Forced control signal YF
3. Signal input Y

Calibration

The MXG461S.. magnetic valves are factory-calibrated at 0 % and 100 % stroke.

When commissioning the valves, however, (especially under extreme conditions of use) there may still be some leakage via control path A → AB with a 0 % stroke control signal (DC 0 V, DC 2 V or DC 4 mA). In this case, the valve can be recalibrated simply and quickly:



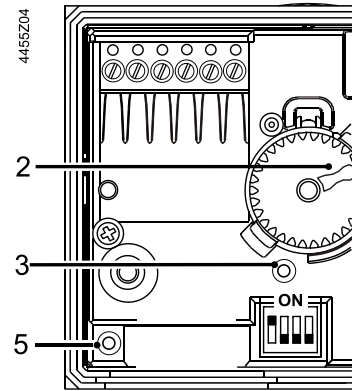

1. Set hand wheel [2] in AUTO-position.
2. Activate calibration using a pointed pin (ø 2 mm) by pressing the button in the opening [3] once.
3. While recalibration is in progress, the LED [5] is flashing green for approximately 10 seconds.
The valve will be briefly closed and fully opened.



If the electronics module is replaced, the valve's electronics must be recalibrated. For that, the hand wheel must be set to AUTO.

Indication of operating state

The two-color LED display indicating operating status can be viewed by opening the cover of the electronics module.

LED	Indication	Function	Remarks, troubleshooting
Green	Lit 	Control mode	Automatic operation; everything o.k.
	Flashing 	Calibration In manual control	Wait until calibration is finished (green or red LED will be lit) Hand wheel in MANUAL or OFF position
Red	Lit 	Calibration error Internal error	Recalibrate (operate button in opening 1x) Replace electronics module
	Flashing 	Mains fault	Check mains network (frequency or voltage outside operating range) or valve blocked
Both	Dark 	No power supply Electronics faulty	Check mains network, check wiring Replace electronics module

As a general rule, the LED can assume only the states shown above (continuously red or green, flashing red or green, or both off).

Sizing

Flow chart

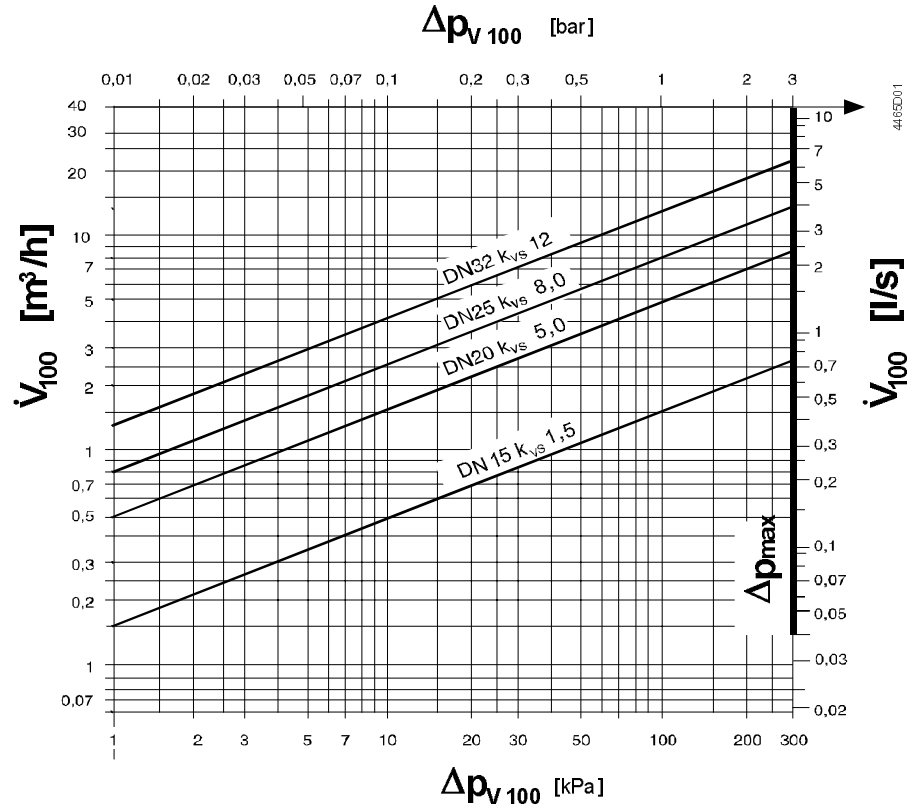

Δp_{v100} = differential pressure across the fully open valve and the valve's control path by a volume flow V_{100}

V_{100} = volumetric flow with valve fully open (H_{100})

Δp_{max} = maximum permissible differential pressure across the valve's control path, valid for the entire actuating range of the motorized valve (mixing: path A-AB, B-AB)

100 kPa = 1 bar \approx 10 mWC

1 m³/h = 0.278 l/s water at 20 °C

Valve characteristic

Equal percentage

Volumetric flow

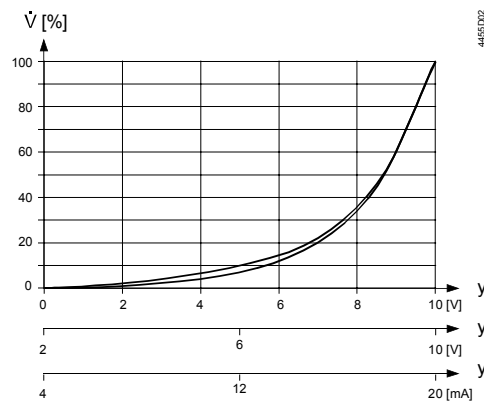

Positioning signals

Linear

Volumetric flow

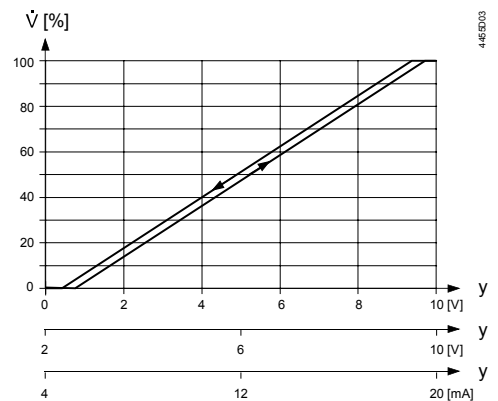

Positioning signals

Connection type ¹⁾

The 4-wire connection should always be given preference!

4-wire connection

Type reference	S _{NA} [VA]	P _{MED} [W]	S _{TR} [VA]	P _{TR} [W]	I _F [A]	wire cross-section [mm ²]		
						1.5	2.5	4.0
MXG461S15-1.5	29	5	≥50	≥30	3.15	max. cable length L [m]		
MXG461S20-5.0						70	110	170
MXG461S25-8.0								
MXG461S32-12								

- S_{NA} = Nominal apparent power
- P_{med} = Typical power consumption in the application (Valve characteristic: equal percentage)
- S_{TR} = Minimum apparent transformer power
- P_{TR} = Minimum DC supply power
- I_F = Minimal required slow fuse
- L = Max. cable length; with 4-wire connections, the max. permissible length of the separate 1.5 mm² copper positioning signal wire is 200 m

¹⁾ All information at AC 24 V or DC 24 V

Engineering notes

Conduct the electric connections in accordance with local regulations on electric installations as well as the internal or connection diagrams.



Safety regulations and restrictions designed to ensure the safety of people and property must be observed at all times!



In open circuits, there is a risk of valve disc seizing caused by scale deposits. Additionally, periodic actuation (twice or three times per week) must be planned.



With closed and open circuits always use a strainer upstream of the valve to increase the valve's functional safety.



Do not touch hot surfaces.



Avoiding flow noise

To reduce flow noise, abrupt reductions in pipe diameters, tight pipe bends, sharp edges or reductions in the vicinity of valves should be avoided. A settling path should be provided.

Recommendation:

- L ≥ 10 x DN, at least 0.4 m

Also, the flow must be free from cavitation

Mounting notes

Mounting and operating instructions are printed on the actuator and on the electronics module.

Caution

The valve may only be used as a mixing or through-port valve, not as a diverting valve. Observe the direction A → AB of flow!

Orientation

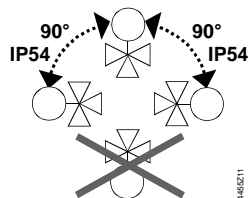

Degree of protection valid only with M20 cable gland supplied by the installer.

Access for installation

It is essential to maintain the specified minimum clearance above and to the side of the actuator and/or electronics module! (refer to «Dimensions», page 12).

Use as straight-through valves

MXG461S.. threaded valves in straight-through applications

Only three-way MXG461S.. valves are supplied. They may be used as straight-through valves by closing off port «B».

Close off port B with a union fitting.

A CrNi-Steel seal disc with 3 gaskets is part of the delivery.

Union fittings conforming to ISO 49 / DIN 2950 must be supplied by the installer.

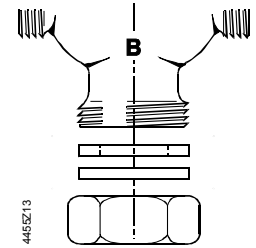

Installation notes



- Do not use hemp for sealing the valve body threads.
- The actuator may not be lagged.
- The MXG461S.. valves are flat-faced allowing sealing with three gaskets provided.
- For notes on electrical installation, see «Connection diagram», page 11.

Maintenance notes

The valves and actuators are maintenance-free.

The low friction and robust design make regular servicing unnecessary and ensure a long service life. The valve stem is sealed from external influences by a maintenance-free gland.

If the red LED is lit, the electronics must be recalibrated or replaced.

Repair

Should the valve electronics prove faulty, the electronics module must be replaced by the ASE1 replacement electronics module. Mounting Instruction no 35678 is included.



Always disconnect power before fitting or removing the electronics module.

After replacing the electronics module, calibration must be triggered in order to optimally match the electronics to the valve (refer to «Calibration», page 5).



Under operating conditions within the limits defined by the application data, the actuator will become hot, but this does not represent a burn risk. Always maintain the minimum clearance specified, refer to «Dimensions», page 12.

Disposal



The valve is considered electrical and electronic equipment for disposal in terms of the applicable European Directive and may not be disposed of as domestic garbage.

- Dispose of the valve through channels provided for this purpose.
- Comply with all local and currently applicable laws and regulations.

Warranty

Application-specific technical data must be observed.

If specified limits are not observed, Siemens will not assume any responsibility. Valve body, magnetic coil and steel bracket form one integral unit. Dismantling destroys the magnetic valve.

Technical data

Functional actuator data

Power supply	Extra low-voltage only	AC / DC 24 V $\pm 20\%$ (SELV, PELV) or AC / DC 24 V $\pm 20\%$ class 2 (US)
	Frequency	45...65 Hz
	Typical power consumption P_{MED} Stand by	Refer to table " Connection type ", page 7 <2 W (valve closed)
	Apparent power S_A	29 VA
	Min. power of transformer S_{TR}	50 VA
	Required fuse I_F	refer to table "Connection type" page 7
	External supply line protection (EU)	<ul style="list-style-type: none"> Fuse slow 6...10 A Circuit breaker max. 13 A, Characteristic B, C, D according to EN 60898 Power source with current limitation of max. 10 A
	Input	Positioning signal Y Impedance DC 0/2...10 V DC 4...20 mA
Forced control YF Impedance Close valve (YF connected to G0) Open valve (YF connected to G) no function (YF not wired)		22 k Ω < AC 1 V > AC 6 V positioning signal Y active
Output	Position feedback signal X Max. load Stroke measurement Nonlinearity	DC 0...10 V; load resistance > 5 k Ω 2 mA // 100 pF Inductive $\pm 3\%$ of end value
	Positioning time	<2 s
Electrical connections	Cable entry point	2 x \varnothing 20.5 mm (for M20)
	Connecting terminal	Screwing terminal 1.5...4 mm ²
	Max. cable length	refer to «Connection type», page 7
Functional data valve	PN class	PN 16 as per EN 1333
	Permissible operating pressure	1 MPa (10 bar)
	Differential pressure $\Delta p_{max} / \Delta p_s$	refer to table «Type summary», page 2
	Valve characteristic ¹⁾	linear or equal percentage, $n_{gl} = 3.0$ and 5.3 VDI / VDE 2173, optimized near the closing point
	Leakage rate at $\Delta p = 0.1\text{ MPa}$ (1 bar)	A \rightarrow AB <0.02 % of k_{VS} value B \rightarrow AB <0.2 % k_{VS} depending on operation conditions
	Permissible media	chilled, cold and hot water, water with anti-freeze, Demineralized water upon request ⁴⁾ (super-clean water, desalinated water, VE water, osmosis water, deionized water) recommendation: water treatment as per VDI 2035
	Medium temperature	1...130 °C
	Stroke resolution $\Delta H / H_{100}$	1 : 1000 (H = Hub)
	Hysteresis	typical 3 %
	Position when de-energized	A \rightarrow AB closed
	Mounting position	upright to horizontal (observe safety standard)
	Mode of operation	Modulating
	Manual operation	Possible, max. 90 %

Materials	Valve body	CrNi high-grade steel cast (no. 1.4581)
	Seat, inner valve, plug	CrNi steel
	Entire inner suit	CrNi steel
	Valve stem seal	EPDM (O-ring)
Dimensions / weight	Dimensions	refer to «Dimensions», page 12
	Weight	refer to «Dimensions», page 12
	Threaded connection	as per ISO 228-1
Standards, directives and approvals	Product standard	EN 60730-x
	As per EMC directive	Automatic electrical controls for household and similar use
	EU Conformity (CE)	For use in residential, commerce, light-industrial and industrial environments
	EAC Conformity	CA1T4465xx ^{*)}
	RCM Conformity	Eurasia conformity for all MX.461..
	UL, cUL	CA1T4465en_C1 ^{*)}
	UL, cUL	AC / DC 24 V
	Pressure Equipment Directive	UL 873 http://ul.com/database
	Pressure accessories	PED 2014/68/EU
	Fluid group 2:	Scope: Article 1, section 1 Definitions: Article 2, section 5
Degree of protection	DN 15...32	without CE-marking as per article 4, section 3 (sound engineering practice) ³⁾
	Protection class	Class III according to EN 60730-1
	Pollution degree	Class 2 according to EN 60730
	Protection degree of housing Upright to horizontal	IP54 to EN 60529 (with M20 cable gland)
	Vibration ²⁾	IEC 60068-2-6 (1 g acceleration, 1...100 Hz, 10 min)
Environmental compatibility	MXG461S..	The product environmental declarations contains data on environmentally compatible product design and assessments (RoHS compliance, materials composition, packaging, environmental benefit, disposal)
	DN 15...25 DN 32	CA2E4465.4en ^{*)} CA2E4465.5en ^{*)}

^{*)} The documents can be downloaded from <http://siemens.com/bt/download>.

¹⁾ Can be selected via DIL switch.

²⁾ In case of strong vibrations, use high-flex stranded wires for safety reasons.

³⁾ Valves where PS x DN < 1000, do not require special testing and cannot carry the CE label.

⁴⁾ The application with demineralized water may result in premature valve wear. Please contact your local Siemens office to determine the optimum use for the valve.

General environmental conditions

	Operation EN 60721-3-3	Transport EN 60721-3-2	Storage EN 60721-3-1
Climatic conditions	Class 3K5	Class 2K3	Class 1K3
Temperature	-5...45 °C	-25...70 °C	-5...45 °C
Humidity	5...95 % r.h.	<95 % r.h.	5...95 % r.h.
Mechanical conditions		Class 2M2	Class 1M2
Biological requirements	Class 3B2		
Chemical active Substances	Class 3C1		
Mechanical active substances	Class 3M2		

Connection terminals

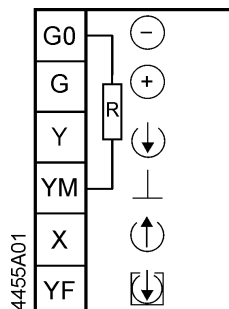

AC / DC 24 V operating voltage	System neutral
	System potential
Positioning signal	DC 0...10 V / 2...10 V / 4...20 mA
	Measuring neutral (= G0)
Position feedback signal	DC 0...10 V
Force control input	

R = Inner resistance between G0 and YM, approx 10 kΩ

Connection diagrams

Caution ⚠ If controller and valve receive their power from separate sources, only one transformer may be earthed on the secondary side.

Caution ⚠ In case of DC power supply, a 4-wire connection is mandatory!

Terminal assignment for controller with 4-wire connection (to be preferred!)

Common transformer

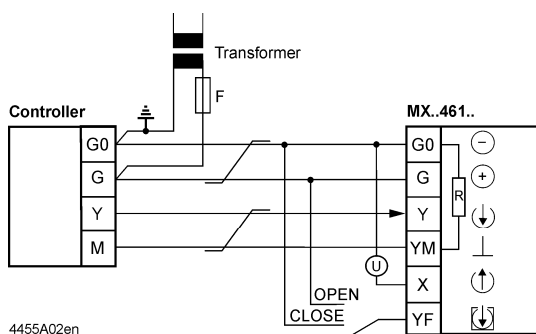

4455A02en

Separate transformer

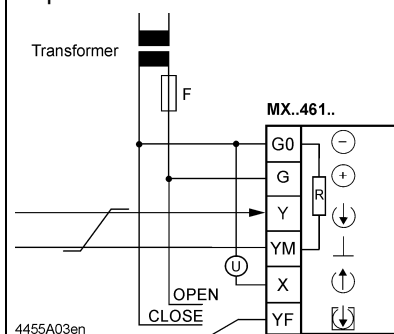

4455A03en

Terminal assignment for controller with 3-wire connection

Common transformer

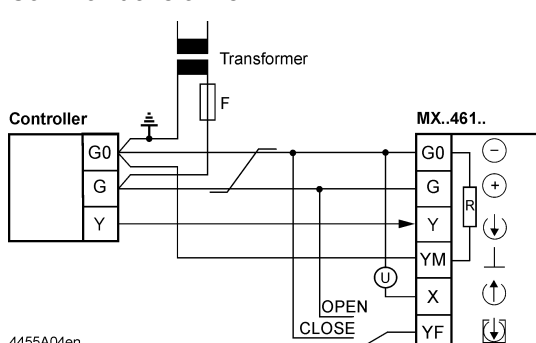

4455A04en

Separate transformer

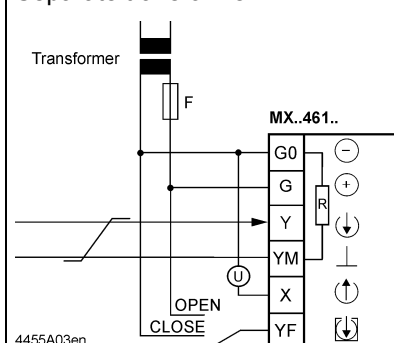

4455A03en



Ⓢ Indication of valve position (only if required). DC 0...10 V → 0...100 % volumetric flow V_{100}

Twisted pairs. If the lines for AC 24 V power supply and the DC 0...10 V (DC 2...10 V, DC 4...20 mA) positioning signal are routed separately, the AC 24 V line need not be twisted.

Warning

Piping must be connected to potential earth!

DIL switch

Factory setting: Valve characteristics 'linear', positioning signal DC 0...10 V. Details see «Configuration DIL switches», page 4.

Calibration

See «Calibration», page 5

Dimensions

Threaded MXG461S.. valves with electronics housing

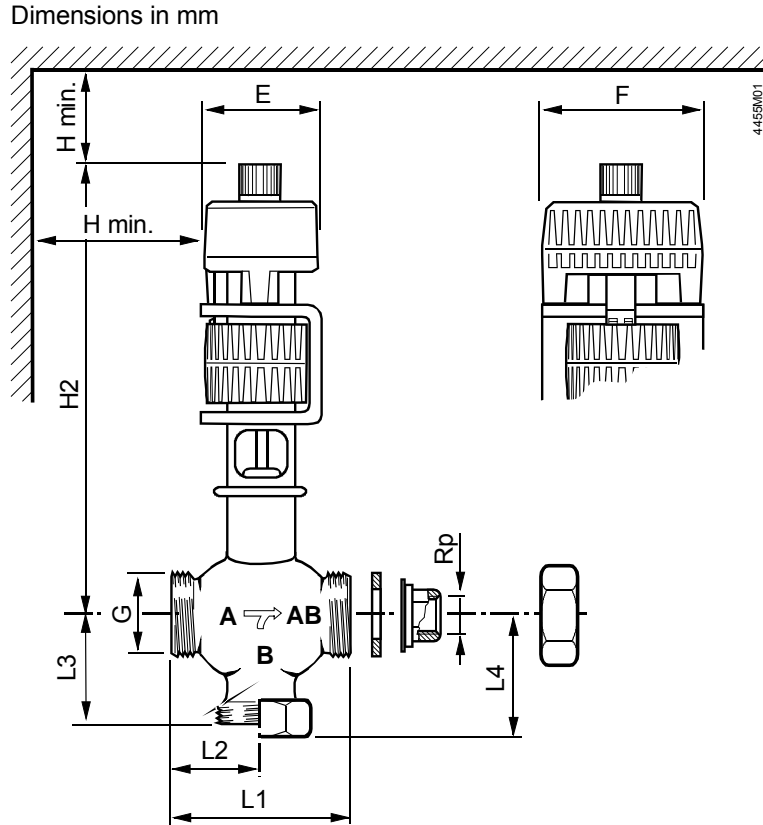

Type reference	DN	Rp [Inch]	G [Inch]	L1	L2	L3 *	L4	H2	H min.	E	F	kg [kg]
MXG461S15-1.5	15	Rp 1/2	G 1B	80	40	42.5	51	240	100	80	100	3.8
MXG461S20-5.0	20	Rp 3/4	G 1 1/4 B	95	47.5	52.5	61	260				4.2
MXG461S25-8.0	25	Rp 1	G 1 1/2 B	110	55	56.5	65	270				4.7
MXG461S32-12	32	Rp 1 1/4	G 2B	125	62.5	67.5	76	285				5.6

- Externally threaded G...B to ISO 228-1
 - Internally threaded Rp... to ISO 7-1
 - Union fittings to ISO 49 / DIN 2950
- * When used as a through-port valve
G weight in kg (incl. packaging)

Revision numbers

Type reference	Valid from rev. No.	Valid from manufact. date
MXG461S15-1.5	..A	02/15 ¹⁾
MXG461S20-5.0	..B	02/15 ¹⁾
MXG461S25-8.0	..A	02/15 ¹⁾
MXG461S32-12	..A	02/15 ¹⁾

¹⁾ MM/YY = Month, Year of manufacturing

Issued by
Siemens Switzerland Ltd
Building Technologies Division
International Headquarters
Gubelstrasse 22
6301 Zug
Switzerland
Tel. +41 58-724 24 24
www.siemens.com/buildingtechnologies

© Siemens Switzerland Ltd, 2011
Technical specifications and availability subject to change without notice.