

Symaro™

Duct sensors

QFM41..

for relative humidity and temperature
with calibration certificates

- Operating voltage AC 24 V / DC 13.5...35 V
- Signal output DC 0...10 V / 4...20 mA for relative humidity and temperature
- Very high measuring accuracy throughout the entire measuring range
- Capacitive humidity measurement
- Test function for loop test
- Range of use $-40...+70$ °C / 0...100 % r. h.

Use

The QFM41.. sensor is used in ventilation and air conditioning plants requiring:

- Very high accuracy and reliability for measuring relative humidity and temperature
- Regular recalibration and readjustment of the sensors

Examples:

- Storage and production facilities in the paper, textiles, pharmaceutical, chemical, electronics industries, etc.
- Laboratories
- Hospitals
- Computer centers
- Greenhouses

Type summary

Type reference	Temperature measuring range	Temperature signal output	Humidity measuring range	Humidity signal output	Operating voltage
QFM4101	-	-	0...100 %	active, 4...20 mA	DC 13.5...35 V
QFM4160	0...50 °C, -40...+70 °C or -35...+35 °C	active, DC 0...10 V	0...100 %	active, DC 0...10 V	AC 24 V or DC 13.5...35 V
QFM4171	0...50 °C, -40...+70 °C or -35...+35 °C	active, 4...20 mA	0...100 %	active, 4...20 mA	DC 13.5...35 V

Ordering and delivery

When ordering, please give name and type reference, e.g.:

Room sensor **QFM4160**

Place a separate order for the service set AQF3153 listed under accessories.

The circular connector with its screwed plug is delivered uninstalled.

Equipment combinations

All systems and devices capable of acquiring and handling the sensor's DC 0...10 V or 4...20 mA output signal.

When using the sensors for minimum or maximum selection, for averaging, or to calculate enthalpy, enthalpy difference, absolute humidity, and dew point, we recommend to use the SEZ220 signal converter (see Data Sheet N5146).

Technical design

Relative humidity

The sensor acquires the relative humidity in the air duct via its capacitive humidity sensing element whose capacitance varies as a function of the relative humidity of the ambient air.

An electronic circuit converts the sensor's signal to a continuous DC 0...10 V or 4...20 mA signal, corresponding to a relative humidity of 0...100 % r. h.

Temperature

The sensor acquires the temperature in the air duct via its sensing element whose electrical resistance changes as a function of the temperature.

This variation is converted to an active DC 0...10 V or 4...20 mA output signal, depending on the type of sensor. The output signal corresponds to a selectable temperature range of 0...50 °C, -35...+35 °C or -40...+70 °C.

Load diagram

Output signal, terminal I1 / I2

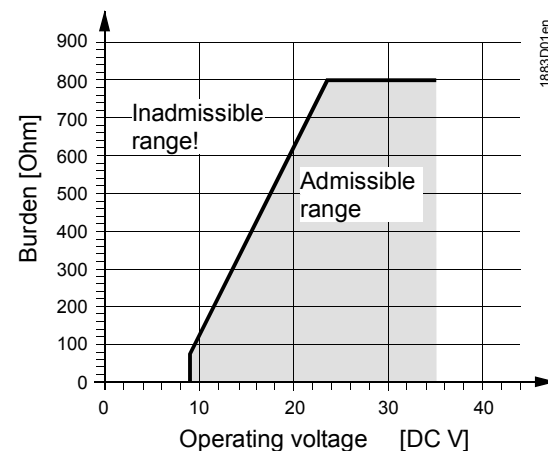

The duct sensor consists of a housing, a printed circuit board, connection terminals, an immersion rod having a measuring tip and a circular connector. The two-part housing comprises a base and screwed removable cover.

A rubber seal is installed between the base and the cover in order to satisfy the requirements of IP 65 degree of protection.

The measuring circuit and the setting element are accommodated on the printed circuit board inside the cover the connection terminals on the base.

The measuring tip is screwed on the immersion rod of the housing.

The sensing elements are located at the end of the measuring tip protected by a screw-on filter cap.

Cable entry is made via the circular connector, which consists of coupling piece with M16 thread and screwed plug. The coupling piece is secured to the housing and internally wired.

Immersion rod and housing are made of plastic and rigidly connected.

The sensor is fitted with the mounting flange supplied with the sensor. The flange is to be placed over the immersion rod and then secured in accordance with the required immersion length.

Setting element

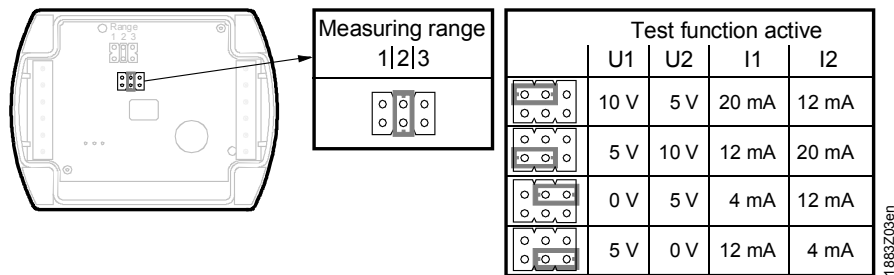

The setting element is located inside the cover. It consists of 6 pins and a shorting plug. It is used for selecting the required temperature measuring range and for activating the test function.

The different jumper positions have the following meaning:

- *For the active temperature measuring range:*
 Jumper in the left position (R1) = -35...+35 °C,
 Jumper in the mid position (R2) = 0...50 °C (factory setting)
 Jumper in the right position (R3) = -40...+70 °C
- *For the active test function:*
 Jumper in the horizontal position: The values available at the signal output are those given in the table “Test function active”

Malfunction

- Should the temperature sensor become faulty a voltage of 0 V (4 mA) will be applied at signal output U2 (I2) after 60 seconds, and the humidity signal at signal output U1 (I1) will reach 10 V (20 mA).
- Should the humidity sensor become faulty a voltage of 10 V (20 mA) will be applied at signal output U1 (I1) after 60 seconds, and the temperature signal will remain active.

Calibration certificates

The sensor and its exchangeable AQF4150 measuring tip are numbered, registered and calibrated prior to delivery. Calibration is traceable to national standards, e.g. METAS, NIST, LNE, PTB. The associated calibration certificates are supplied with the sensor.

**Service set
AQF3153**

The service set comprises three measuring tips without sensor element. Each tip signals a predefined temperature and humidity value to the basic unit:

- 85 % r. h., 40 °C
- 50 % r. h., 23 °C
- 20 % r. h., 5 °C

The fixed values are available at the signal outputs. The accuracy is the same as for the test function. The measuring tips can be exchanged in operation.

The service set allows for easy and quick loop test performance as recommended by Vertical Market Pharma and offered by their calibration service in various countries.

Accessories

<i>Name</i>	<i>Type reference</i>
Measuring tip certified (exchangeable)	AQF4150
Service set (for loop test)	AQF3153
Filter cap (for replacement)	AQF3101
3 m cable for remote measurement	AQY2010

Engineering notes

A transformer for safety extra low-voltage (SELV) with separate windings for 100 % duty is required to power the sensor. When sizing and protecting the transformer, the local safety regulations must be complied with.

When sizing the transformer, the power consumption of the duct sensor must be taken into consideration.

For correct wiring of the sensor, refer to the Data Sheets of the devices with which the sensor is used.

The permissible line lengths must be considered.

**Cable routing and
cable selection**

It must be considered for routing of cables that the longer the cables run side by side and the smaller the distance between them, the greater the electrical interference.

Shielded cables must be used in environments with EMC problems.

Twisted pair cables are required for the secondary supply lines and the signal lines.

Note to QFM4171

Terminals G1(+) and I1(-) for the humidity output must always be connected to power, even if only terminals G2(+) and I2(-) of the temperature output are used!

Mounting notes

Location

Mount the sensor in the center of the duct wall. If used together with steam humidifiers, the minimum distance after the humidifier must be 3 m to max 10 m.

Fit the sensor in the extract air duct if the application involves dew point shifting.

Fit only the flange to the duct wall. The sensor is then inserted through the flange and engaged.

Caution!

- The seal between base and cover must not be removed, or else degree of protection IP 65 will be no longer ensured.
- The sensing elements inside the measuring tip are sensitive to impact. Avoid any such impact on mounting.

Mounting instructions

Mounting Instructions are printed on the inner side of the package.

Commissioning notes



Check wiring before switching on power. The temperature measuring range must be selected on the sensor, if required.

Wiring and the output signals can be checked by making use of the test function (refer to "Mechanical design").

We recommend not to use voltmeters or ohmmeters directly at the sensing element. In the case of the simulated passive output signals, measurements with commercially available meters cannot be made (measuring current too small).

Disposal



The devices are considered electronics devices for disposal in terms of European Directive 2012/19/EU and may not be disposed of as domestic waste.

- Dispose of the device via the channels provided for this purpose.
- Comply with all local and currently applicable laws and regulations.

Technical data

Power supply	Operating voltage	AC 24 V \pm 20 % or DC 13,5...35 V (SELV) or AC/DC 24 V class 2 (US)
	Frequency	50/60 Hz at AC 24 V
	Power consumption	\leq 1 VA
	External supply line protection	Fuse slow max. 10 A or Circuit breaker max. 13 A Characteristic B, C, D according to or Power source with current limitation of max. 10 A
Cable lengths for the measuring signal	Max. perm. cable lengths	refer to Data Sheet of the device handling the signal
Functional data "Humidity sensor"	Measuring range	0...100 % r.h.
	Measuring accuracy at 23 °C and AC/DC 24 V in 0...100 % r.h.	\pm 2 % r.h.
	Temperature dependency	\leq 0.05 % r.h./°C
	Time constant	< 20 s
	Supply air velocity	20 m/s
	Output signal, linear (terminal U1)	DC 0...10 V $\hat{=}$ 0...100 % r.h., 1 mA max.
	Output signal, linear (terminal I1) Burden	4...20 mA $\hat{=}$ 0...100 % r.h. refer to "Function"
	Functional data "Temperature sensor"	Measuring range
Sensing element		Pt 1000
Measuring accuracy at AC/DC 24 V in 23 °C 15...35 °C -35...+70 °C		\pm 0.3 K \pm 0.6 K \pm 0.8 K
Time constant		< 3.5 min. in with 2 m/s moved air
Output signal, linear (terminal U2)		DC 0...10 V $\hat{=}$ 0...50/-35...+35/-40...+70 °C max. 1 mA
Output signal, linear (terminal I2) Burden		4...20 mA $\hat{=}$ 0...50/-35...+35/-40...+70 °C refer to "Function"
Degree of protection		Protection class
	Protection degree of housing	IP65 according to EN 60529 in the built-in state
Electrical connections	Connector with screwed plug Screw terminals for Cable entry	Lumberg RSC 4/9 0.75 mm ² max. 4...8 mm dia.
Environmental conditions	Operation to	
	Climatic conditions	class 4K2 to IEC 60 721-3-4
	Temperature (housing with electronics)	-40...+70 °C
	Humidity	0...100 % r. h. (with condensation)
	Mechanical conditions	class 3M2 to IEC 60 721-3-3
	Transport to	IEC 60721-3-2
Climatic condition	class 2K3	
Temperature	-40...+70 °C	
Humidity	< 95 % r.h.	
Mechanical conditions	class 2M2	

Materials and colors	Base	polycarbonate, RAL 7001 (silver-grey)
	Cover	polycarbonate, RAL 7035 (light-grey)
	Immersion rod	polycarbonate, RAL 7001 (silver-grey)
	Filter cap	polycarbonate, RAL 7001 (silver-grey)
	Mounting flange	PA66 – GF35 (black)
	Circular connector	
	Connector with screwed plug	Lumberg RSC 4/9
	Contact carrier and body	PA, black
	Knurled nut and contact	CuZn, nickel-plated
	Coupling piece	Lumberg RKFM 4/0,5 M
Contact carrier	TPU	
Casing and contact	CuZn, nickel-plated	
Sensor (complete assembly)	silicon-free	
Packaging	corrugated cardboard	
Directives and Standards	Product standard	EN 60730-1
		Automatic electrical controls for household and similar use
	Electromagnetic compatibility (Applications)	For use in residential, commerce, light-industrial and industrial environments
	EU Conformity (CE)	CE1T1883xx ^{*)}
	RCM Conformity	CE1T1864en_C1 ^{*)}
UL	UL 873, http://ul.com/database	
Environmental compatibility	The product environmental declaration CE1E1882 ^{*)} contains data on environmentally compatible product design and assessments (RoHS compliance, materials composition, packaging, environmental benefit, disposal).	
Weight	Incl. packaging	0.244 kg
	AQF3153	0.066 kg
	AQF4150	0,050 kg

*) The documents can be downloaded from <http://siemens.com/bt/download>.

Connection terminals

QFM4160

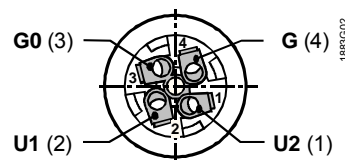
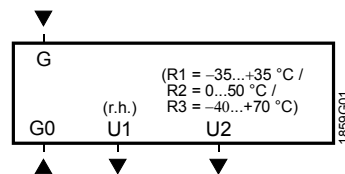

Front view:
Connector fitted,
body removed

QFM4101, QFM4171

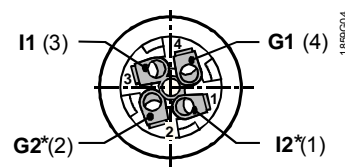
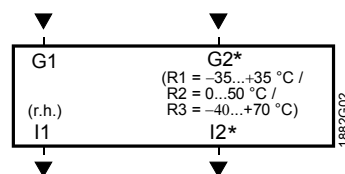

Front view:
Connector fitted,
body removed

* G2, I2 Only with QFM4171.

G, G0 Operating voltage AC 24 V (SELV) or DC 13.5...35 V

G1, G2 Operating voltage DC 13.5...35 V

U1 Signal output DC 0...10 V for relative humidity 0...100 %

U2 Signal output DC 0...10 V for temperature range 0...50 °C (R2 = Werkeinstellung),
–35...+35 °C (R1) oder –40...+70 °C (R3)

I1 Signal output 4...20 mA for relative humidity 0...100 %

I2 Signal output 4...20 mA for temperature range 0...50 °C (R2 = Werkeinstellung),
–35...+35 °C (R1) oder –40...+70 °C (R3)

Note on connection terminals of the QFM4171:

Terminals G1(+) and I1(–) for the humidity output must always be connected to power, even if only the temperature output G2(+) and I2(–) is used!

Dimensions

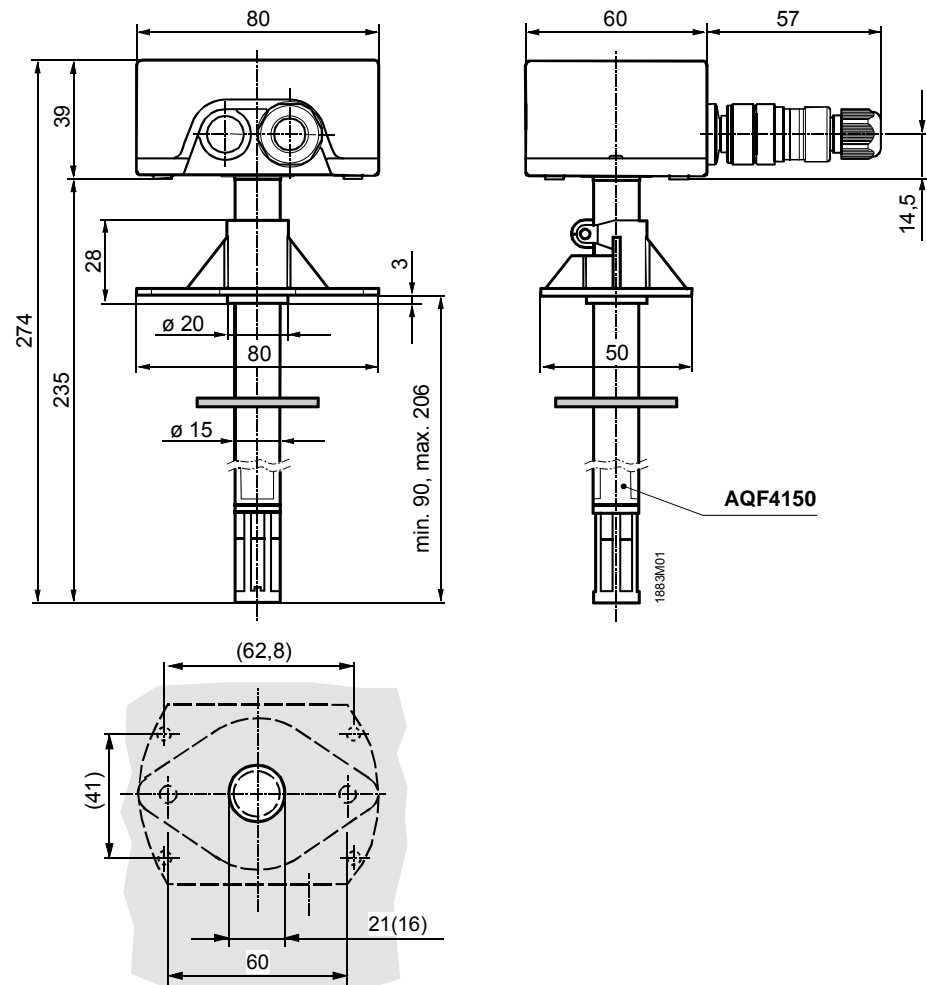

Drilling template with (without) mounting flange

Dimensions in mm