



RDF800
RDF800/NF

Touch screen flush-mount standalone room thermostats

For 2-pipe, 2-pipe with electrical heater, and 4-pipe fan coil units

For universal applications

For use with compressors in DX type equipment

-
- Touch screen
 - Large display with backlight
 - 2P / PI / P control
 - Outputs for ON/OFF or 3-position control
 - Outputs for 3-speed or 1-speed fan
 - 2 multifunctional inputs for keycard contact, external sensor, etc.
 - Independent function for window contact, presence detector (standard presence and hotel presence)
 - Operating modes: Comfort, Economy and Protection
 - Automatic or manual fan speed control
 - Automatic or manual heating / cooling changeover
 - Minimum and maximum limitation of room temperature setpoint
 - Control depending on the room or the return air temperature
 - Adjustable commissioning and control parameters
 - AC 230 V operating voltage
 - RDF800: Mounting on round box, with min 60 mm diameter or recessed square 86 mm box with 60.3 mm fixing centers and min 40 mm depth
 - RDF800/NF: Mounting on recessed square 86 mm box with 60.3 mm fixing centers and min 40 mm depth, requires additional mounting frame

Use

Room temperature control (heating or cooling) in individual rooms and zones by means of:

- 2-pipe fan coil units
- 2-pipe fan coil units with electrical heater
- 4-pipe fan coil units
- Chilled /heated ceiling
- Chilled /heated ceiling and electrical heater
- Chilled ceiling and radiator / under floor heating
- Compressors in DX-type equipment
- Compressors in DX-type equipment with electrical heater

The room thermostats are delivered with a fixed set of applications. The relevant application is selected:

Local DIP switch and HMI

Functions

- Room temperature control via built-in temperature sensor or external room temperature / return air temperature sensor
- Changeover between heating and cooling mode (automatically via local sensor or manually)
- Selection of applications via DIP switches
- Selection of operating mode via touch screen
- 1- or 3-speed fan control (automatically or manually)
- Display of current room temperature or setpoint in °C and/or °F
- Minimum and maximum limitation of room temperature setpoint
- Keylock function: unlock, total lock and setpoint
- 2 multifunctional inputs, freely selectable for:
 - External room temperature or return air temperature sensor
 - Sensor for automatic heating / cooling changeover (RDF...)
 - Window contact
 - Dew point sensor (RDF...)
 - Electric heater enable (RDF...)
 - **Fault input**
 - Presence detector
- Advanced fan control function, such as: fan kick, fan start delay, and selectable fan operation (enable, disable or depending on heating or cooling mode)
- Purge function together with 2-port valve in a 2-pipe changeover system
- Reminder to clean fan filters (adjust with P62)
- Floor heating temperature limitation
- Reload factory settings for commissioning and control parameters
- Wizard function for easy commissioning via HMI



Note: The functional descriptions for the thermostat can be referred to the basic documentation P3174.

Applications

The thermostats support the following applications, which can be configured using the DIP switches on the inner side of the thermostat's front panel.

Applications for fan coil systems

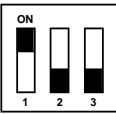
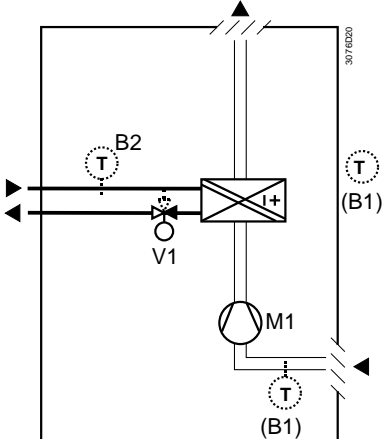
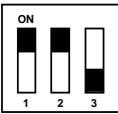
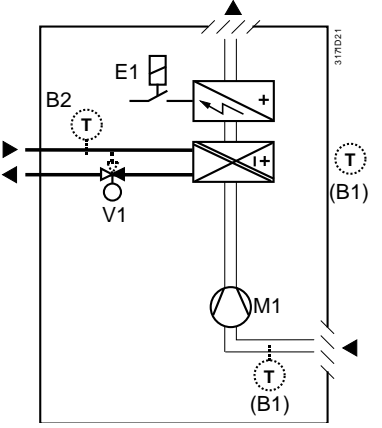
Application and output signal, DIP switches, diagram

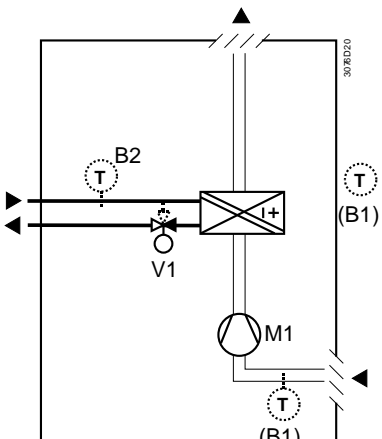
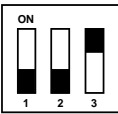
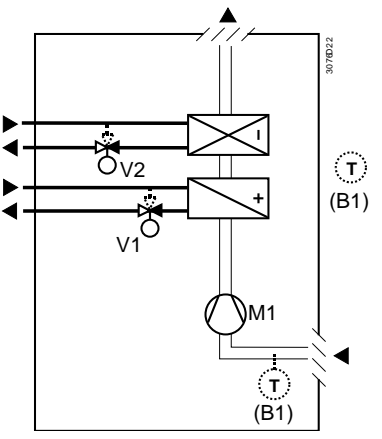
<p>• 2-pipe fan coil unit (heating or cooling)</p> <p>ON/OFF</p>  	<p>• 2-pipe fan coil unit with el. heater (heating or cooling)</p> <p>ON/OFF</p>  
<p>• 2-pipe fan coil unit (heating or cooling)</p> <p>3-position</p>  	<p>• 4-pipe fan coil unit (heating and cooling)</p> <p>ON/OFF</p>  

V1 Heating or heating / cooling valve actuator

V2 Cooling valve actuator

E1 Electric heater

B1 Return air temperature sensor or external room temperature sensor (optional)

B2 Changeover sensor (optional)

M1 3- or 1-speed fan

Applications for Universal systems

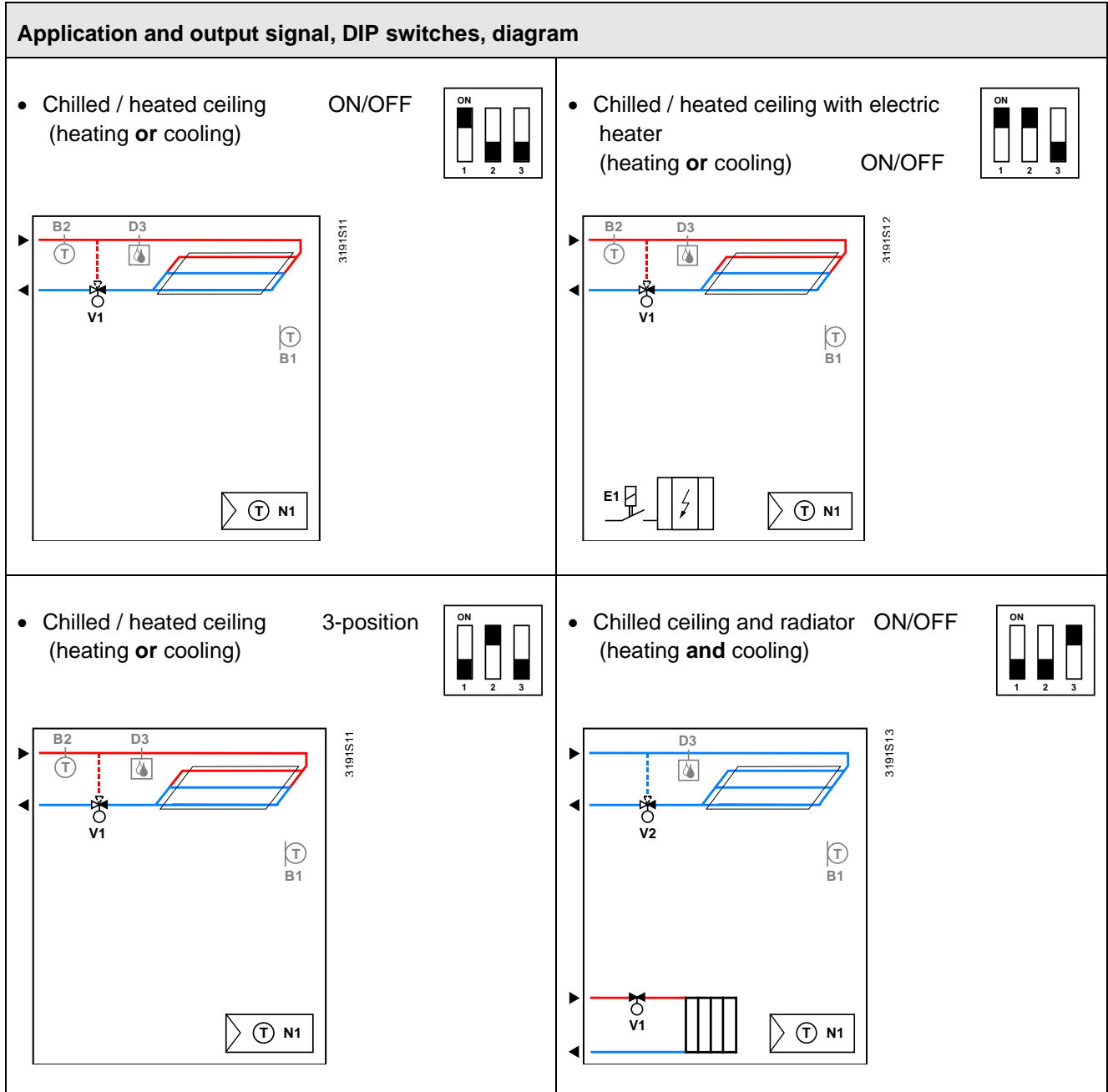

V1 Heating or heating / cooling valve actuator

V2 Cooling valve actuator

E1 Electric heater

B1 Return air temperature sensor or external room temperature sensor (optional)

B2 Changeover sensor (optional)

D3 Dewpoint sensor

Applications for heat pump systems

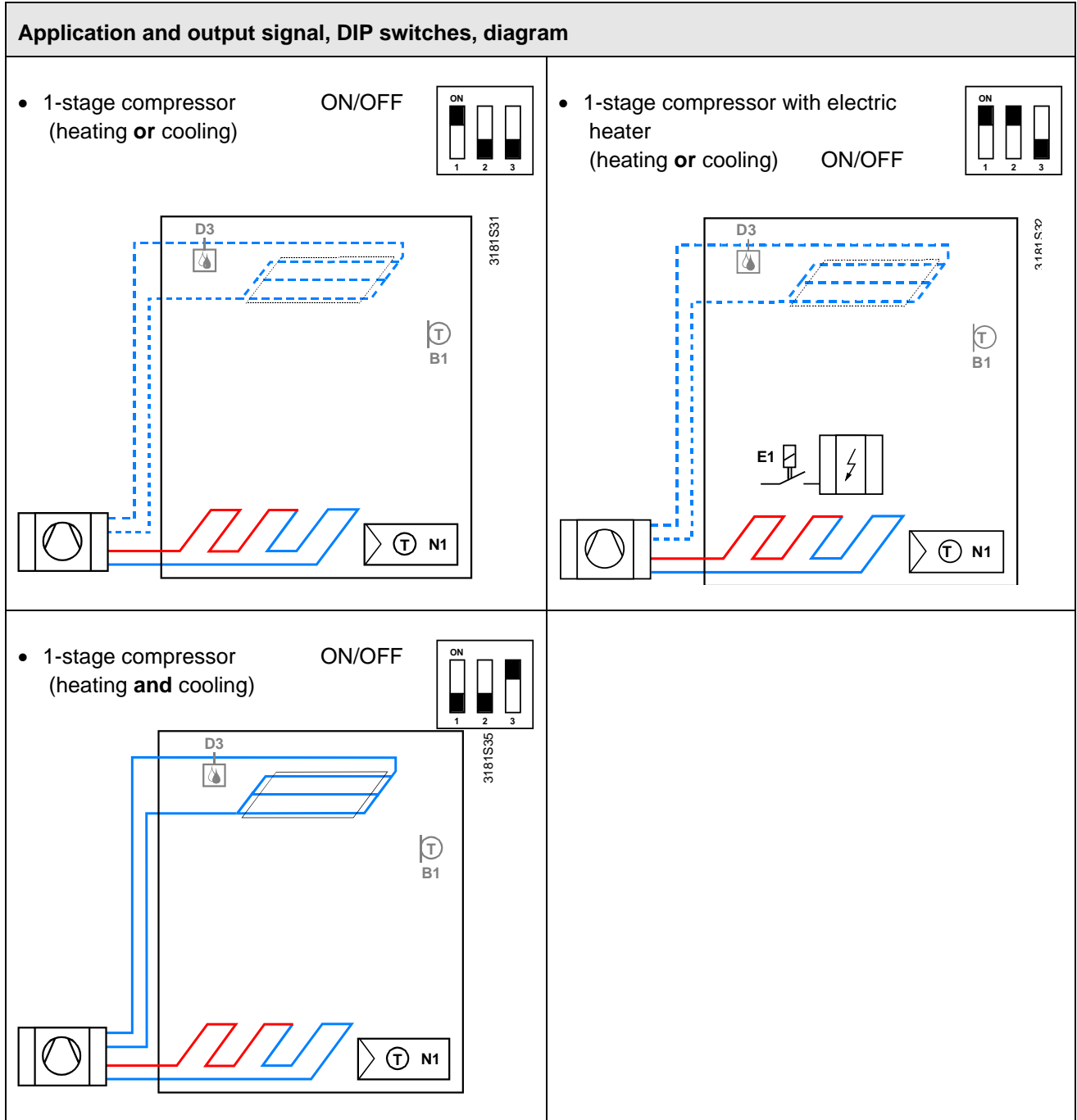

N1 Thermostat

E1 Electric heater

B1 Return air temperature sensor or external room temperature sensor (optional)

D3 Dewpoint sensor

Type summary

Product no.	Stock no.	Application	Operating voltage	Control outputs			Suitable for
				3-pos	ON/OFF		
RDF800	S55770-T396	Fan coil, universal heat pump	AC 230 V	1 ¹⁾	2 ¹⁾		Round or square conduit boxes
RDF800/NF ²⁾	S55770-T397	Fan coil, universal heat pump	AC 230 V	1 ¹⁾	2 ¹⁾		Square conduit boxes ²⁾









¹⁾ Selectable: ON/OFF or 3-position according to applications.

²⁾ Mounting frames are not included and must be ordered separately. See "Accessories"







Ordering

- When ordering, indicate the product number, SSN and name.
For example: **RDF800/NF (S55770-T397) room thermostat**
RDF800 (S55770-T396) room thermostat
- A mounting frame must be ordered for RDF800/NF installation (See "Accessories").
- Order valve actuators separately.

Equipment combinations

	Type of unit	Product no.	Data sheet
	Cable temperature sensor or changeover sensor, cable length 2.5 m NTC (3 kΩ at 25 °C)	 QAH11.1	1840
	Room temperature sensor NTC (3 kΩ at 25 °C)	 QAA32	1747
	Cable temperature sensor, cable length 4 m NTC (3 kΩ at 25 °C)	 QAP1030/UFH	1854
	Condensation / Dew point monitor	 QXA2601 / QXA2602 / QXA2603 / AQX2604	3302
ON/OFF actuators	Electromotoric ON/OFF actuator	 SFA21...	4863
	Electromotoric ON/OFF valve and actuator (only available in AP, UAE, SA and IN)	 MVI.../MXI...	A6V11251892
	Zone valve actuators (only available in AP, UAE, SA and IN)	 SUA...	4832
	Thermal actuator (for radiator valve)	 STA23...	4884
	Thermal actuator (for small valves 2.5 mm)	 STP23...	4884

3-position actuators

Type of unit		Product no.	Data sheet
Electrical actuator, 3-position (for radiator valve)		SSA31...	4893
Electrical actuator, 3-position (for small valve 2.5 mm)		SSP31...	4864
Electrical actuator, 3-position (for small valve 5.5 mm)		SSB31...	4891
Electrical actuator, 3-position (for 2- and 3-port valves / V...P45)		SSC31...	4895
Electrical actuator, 3-position (for small valve 5.5 mm)		SSD31...	4861
Electromotoric actuator, 3-position (for small valves 5.5 mm)		SAS31...	4581

- Note:
- For the maximal number of actuators in parallel, refer to information in the data sheets of the selected actuators and to this list, depending on which value is lower:
- Parallel operation of max 6 SS... actuators (3-pos) is possible.
 - Parallel operation of max 10 ON/OFF actuators is possible.

Accessories

Designation		Product no. / SSN	Data sheet
Changeover mounting kit (50 pcs / package)		ARG86.3	N3009
Single mounting frame, Ivory White (for RDF800/NF only)		ARG800.1 / S55770-T370	--

The thermostats consist of the following parts:

- Front panel with electronics, operating elements and built-in room temperature sensor.
- Mounting base with power electronics.
- Additional mounting frame is required for RDF800/NF to complete the installation while RDF800 unit comes with its own mounting frame.





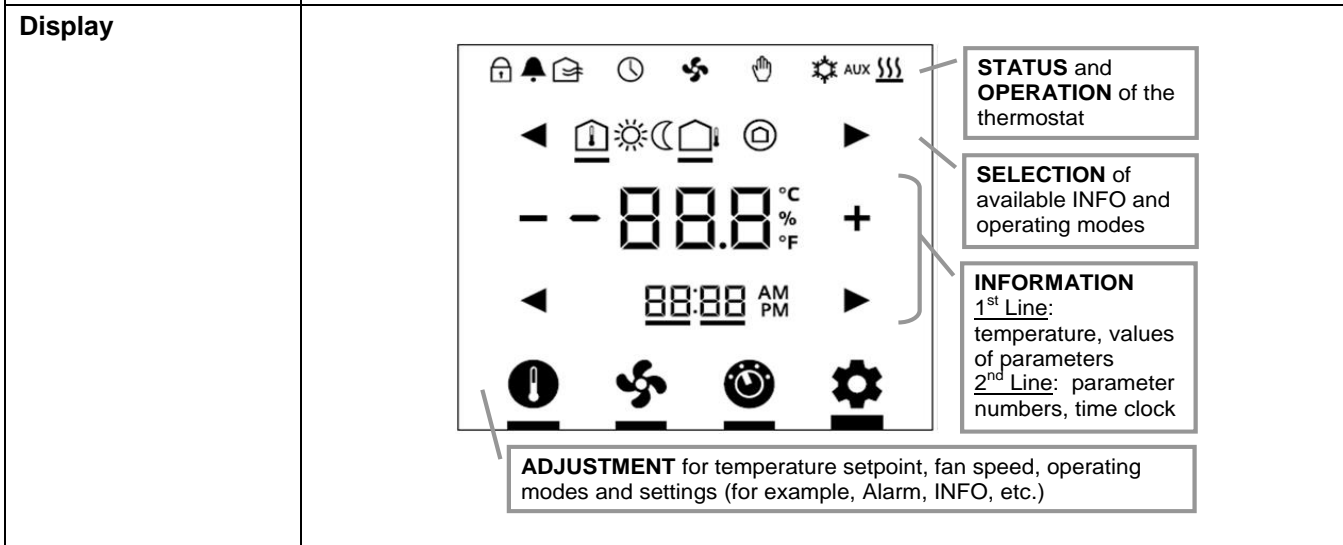

The rear of the mounting base contains the screw terminals.

Slide the front panel in the mounting base and snap on.



Status symbols:			
	Key lock		Manual override
	Alarm / Service reminder		Cooling active
	Scheduler via bus (not valid for standalone versions)		Heating active
	FAN ACTIVE	AUX	Auxiliary heat active
Selection symbols:			
	Indoor temperature		Comfort mode
	Outdoor temperature (not valid for standalone versions)		Economy mode
			Protection mode

Operational icons:	
	Increment, decrement OR selection
	Selection OR move to next items
	Temperature OR parameter values, and etc.
	Parameter number OR password, and etc. Time clock (12 / 24 hour) (not valid for standalone versions)
	Setpoint mode (temperature only)
	Fan mode OR fan speed mode
	Operating mode
	Setting mode



Operations	Function
Touch 	to select setpoint mode; adjust temperature value using +/-.
Touch 	to select fan mode; adjust fan speed using +/-.
Touch 	to select operating mode; select ON/ECO/OFF using +/-.
Touch 	to select the INFO screen, display room using ◀/▶ if available.
	to select the desired H/C control sequence using +/- if manual H/C changeover (P01 = 2) is selected.
	to display alarms if the  icon is displayed; use ◀/▶ icon to select different alarms for viewing.
Touch  for 5 seconds	to select parameter mode (Service/Expert level).

Setting parameters using the local HMI



Wake up the thermostat by touching the screen display.

Entering the Service level

Factory setting for the Service level password is **00 00**.

1. Touch and hold down the  icon for 5 seconds. Then set the first 2-digit number to **00** using / .



2. Touch the last 2-digit number and set it to **00** using / .

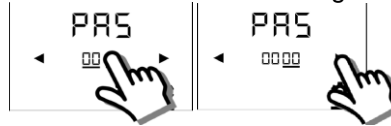

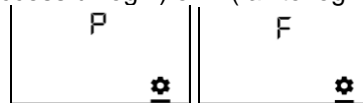

3. After 3 seconds, **P** (successful login) or **F** (fail to login) is displayed.

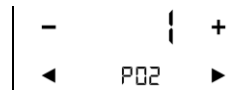

4. If the login failed, reenter the correct password as per step 1 above. After successful login, the first parameter is displayed as shown in the following example:





- Notes:**
- Touch any icon to exit.
 - Touch /  to select any parameter and  to adjust values.
 - When reaching **END**, touch **END** to exit.

Entering the Expert level

Follow the same steps for entering the Expert level.
Factory setting for Expert level password is **99 99**.

Configuring parameters

After entering the correct password, the screen displays as follows. Touch /  to advance or return to the desired parameter and use  to select the desired available value.

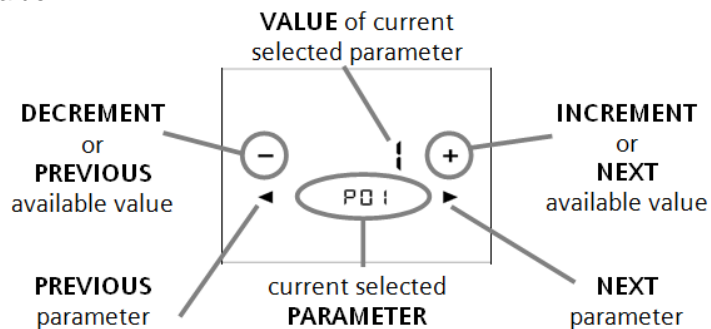

Resetting parameters

The factory setting for the control parameters can be reloaded using P71, by setting the value to **ON**.

Service level parameters

Parameter	Name	Factory setting	Range	RDF800..	Dependencies
	Service level				
P01	Control sequence	2-pipe: 1 = cooling only 4-pipe: 4 = heating and cooling	0 = heating only 1 = cooling only 2 = H/C changeover manual 3 = H/C changeover auto 4 = heating and cooling	✓	
P02	Operation using room op selector	1	1 = Comfort – Protection 2 = Comfort - Economy – Protection	✓	
P04	Unit	0	0 = °C 1 = °F	✓	
P05	Measured value correction (for built-in/external sensor)	0 K	- 5...+5 K	✓	
P06	Standard display	0	0 = room temperature 1 = setpoint	✓	
P08	Comfort basic setpoint	21 °C	5...40 °C	✓	
P09	Comfort setpoint minimum	5 °C	5...40 °C	✓	
P10	Comfort setpoint maximum	35 °C	5...40 °C	✓	
P11	Economy heating setpoint	15 °C	OFF, 5...WCoolEco; WCoolEco = 40 °C max.	✓	
P12	Economy cooling setpoint	30 °C	OFF, WHeatEco...40 °C; WHeatEco = 5 °C min.	✓	
P13	Electric heater when cooling	ON	ON: Enabled OFF: Disabled	✓	
P14	"Screen lock" function	0	0: Unlock 1: Lock 2: Setpoint adjustable	✓	
P15	Fan stage in dead zone (Comfort)	0	0 = disabled 1 = low speed (Heat and Cool) 2 = low speed (Cooling only)	✓	
P16	Buzzer function	ON	ON: Enabled OFF: Disabled	✓	

Note: Parameter display depends on the selected application and function.

Expert level parameters with diagnostics and test

Parameter	Name	Factory setting	Range	RDF800..	Dependencies
	Expert level				
P30	Heat P-band Xp/switching differential	2 K	0.5...6 K	✓	
P31	Cool P-band Xp/switching differential	1 K	0.5...6 K	✓	
P33	Dead zone Comfort mode	2 K	0.5...5 K	✓	Appl.)
P34	Setpoint differential	2 K	0.5...5 K	✓	Appl.)

Parameter	Name	Factory setting	Range	RDF800..	Dependencies
	Expert level				
P35	Integral action time Tn	45 min	0...120 min	✓	P46
P36	H/C changeover switching point cooling	16 °C	10...25 °C	✓	P38, P40
P37	H/C changeover switching point heating	28 °C	27...40 °C	✓	P38, P40
P38	Input X1	3 = window contact	0 = --- (no function) 1 = room temp ext. sensor/ return air temp (AI) 2 = H/C changeover (AI/DI) 3 = window contact (DI) 4 = dew point sensor (DI) 5 = enable electric heater (DI) 6 = fault input (DI) 10 = presence detector (DI)	✓	P40
P39	Normal position input X1	0 (NO.)	0 = NO. (Normally Open) 1 = NC. (Normally Closed)	✓	P38
P40	Input X2	1 = ext. sensor	0 = --- (no function) 1 = room temp ext. sensor/ return air temp (AI) 2 = H/C changeover (AI/DI) 3 = window contact (DI) 4 = dew point sensor (DI) 5 = enable electric heater (DI) 6 = fault input (DI) 10 = presence detector (DI)	✓	P38
P41	Normal position input X2	0 (NO.)	0 = NO. (Normally Open) 1 = NC. (Normally Closed)	✓	P40
P44	Actuator running time Y1/Y2	150 s	20...300 s	✓	P46
P45	Power of electric heater on Y2 (for adaptive temperature compensation)	0.0 kW	0.0...1.2 kW	✓	
P46	Output Y1/Y2	ON/OFF (1)	0 = 3-position 1 = ON/OFF	✓	Appl.
P48	ON time minimum 2-pos output	1 min.	1...20 min	✓	P46
P49	OFF time minimum 2-pos output	1 min.	1...20 min	✓	
P50	Purge time	OFF	OFF: Not active 1...5 min: Active with selected duration	✓	P38,
P51	Flow temp limit floor heating	OFF	OFF, 10...50 °C	✓	P38, P40
P52	Fan control	1	0 = disabled 1 = enabled 2 = heating only 3 = cooling only	✓	
P53	Fan speeds	3-speed	1 = 1-speed 2 = 3-speed	✓	P52
P54	Fan overrun time	60 s	0...360 s	✓	P52, Appl.
P55	Fan speed switching point high	100%	80...100%	✓	P52, P53
P56	Fan speed switching point med	65%	30..75%	✓	P52, P53
P57	Fan speed switching point low	10%	1...15%	✓	P52, P53
P58	Fan kick start	ON	ON: Enabled OFF: Disabled	✓	P52
P59	On time minimum fan	2 min	1...6 min	✓	P52

Parameter	Name	Factory setting	Range	RDF800..	Dependencies
	Expert level				
P60	Periodic fan kick Comfort	OFF	0...89 min, OFF(90)	✓	P52
P61	Periodic fan kick Eco	OFF	0...359 min, OFF(360)	✓	P52
P62	Service filter	OFF (0)	OFF, 100...9900 h	✓	P52
P65	Protection heating setpoint	8 °C	OFF, 5...WCoolProt; WCoolProt = 40 °C max.	✓	
P66	Protection cooling setpoint	OFF	OFF, WHeatProt... 40; WHeatProt = 5°C min.	✓	
P67	Fan start delay	0 s	0...360 s	✓	P52, P46
P69	Temporary Comfort setpoint	OFF	OFF = disabled ON = enabled	✓	
P71	Restore factory setting	OFF	OFF = disabled ON = reload start	✓	
P77	Presence Detector Mode	1: Standard Presence Mode	1: Standard Presence Mode 2: Hotel Presence Mode	✓	P38, P40

) Appl. = applications

Parameter	Name	Range	RDF800..	Dependencies
	Diagnostics and test			
d01	Application number	NONE = (no application) 2P = 2-pipe 2P3P = 2-pipe 3-position 2PEH = 2-pipe with electric heater 4P = 4-pipe	✓	
d02	X1 state	0 = not activated (for DI) 1 = activated (DI) 0...49 °C = current temp. value (for AI) 00 ⚙ = H/C input shorted 100 ⏏ = H/C input open	✓	
d03	X2 state	0 = not activated (for DI) 1 = activated (DI) 0...49 °C = current temp. value (for AI) 00 ⚙ = H/C input shorted 100 ⏏ = H/C input open	✓	
d05	Test mode for checking the Y1/Y2 actuator's running direction ³⁾	"--" = no signal on outputs Y1 and Y2 OPE = output Y1 forced opening CLO = output Y2 forced closing	✓	P46
d07	Software version	Ux.xx	✓	

³⁾ This parameter can only be quit when the setting is back at "--"
Press buttons + and – simultaneously to escape.

Mounting and installation

Mount the room thermostat on a conduit box. Do not mount on a wall in niches or between bookshelves, behind curtains, above or near heat sources, or exposed to direct solar radiation. Mount about 1.5 m above the floor.

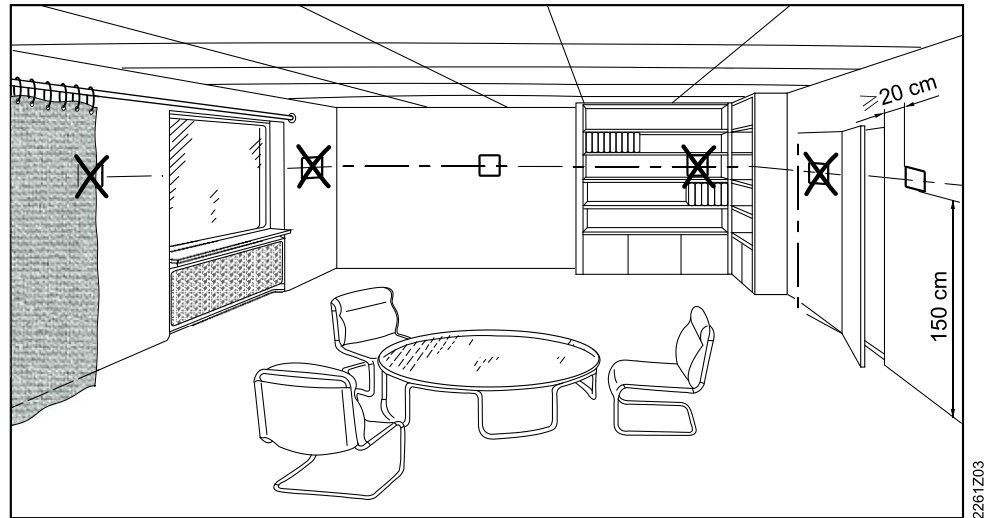

Mounting / Dismounting

- Do not apply excessive force on screws! The deformation of the mounting frame may lead to improper connections and operation of the unit.
- Mount the room thermostat on a clean, dry indoor place without direct airflow from a heating / cooling device, and not expose to drips or splashes water.
- In case of limited space in the conduit box, use the mounting spacer ARG70.3 to increase the headroom by 10mm.
- Before removing the front cover, disconnect the power supply.

Wiring

See the User Manual for the installation instructions enclosed with the thermostat.

WARNING

Wire, protect and earth in compliance with local regulations.





Risk of fire and injury due to short-circuits!

- Adapt the line diameters as per local regulations to the rated value of the installed overcurrent protection device.
- The AC 230 V mains supply line must have an external circuit breaker with a rated current of no more than 10 A.
- The maximum current loading (including fan and valves) is 10 A.
- Use only valve actuators rated for AC 230 V.
- Disconnect from supply before removing the unit from its mounting plate.
- Do not connect more than one fan coil unit to the Qs output of the thermostat.
- Do not connect terminal Y1 or Y2 to either L or N.
- Do not use terminal Y1 or Y2 as AC 230 V power supply.
- Use cables with min 230 V insulation for both SELV inputs X1-M / X2-M since the conduit box carries AC 230 V mains voltage.
- Several switches (e.g. window contact) may be connected in parallel for both inputs X1-M / X2-M. However, overall maximum contact sensing current for switch rating must be considered.

Commissioning notes

Before power up

Set DIP switches to select the desired application before power up:

Commissioning method	DIP switches	LCD display	Applications
Local setup		APP 2P	2-pipe
		APP 2PEH	2-pipe with electric heater
		APP 4P	4-pipe
		APP 2P3P	2-pipe with 3-position output

After DIP switch setting, complete the installation and power up the thermostat.



Notes: Other DIP switch position will have no effect, i.e. NONE will be shown on LCD display when the unit is powered up if selected .
As soon as the application is changed, the thermostat reloads the factory setting for all control parameters.

Wizard

After DIP switches are selected and the thermostat is powered up, the wizard function guides users to configure the basic parameters for normal operation according to the table below.

Touch ◀ / ▶ to advance / return to any parameter;

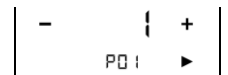
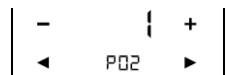
Touch + / - to change value.

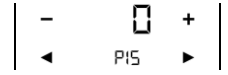
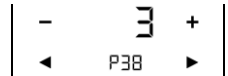
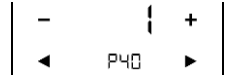
LCD display	Parameter	Range	Factory setting
	Control sequence	0: Heating only 1: Cooling only 2: Manual changeover 3: Auto changeover 4: Heating and Cooling	2-pipe = 1 4-pipe = 4
	User operating mode profile	1: comfort > protection 2: comfort > economy > protection	1
	Selection of °C or °F	0: °C 1: °F	0
	Standard display	0: Room temperature 1: Setpoint	0
	Fan Stage in Deadzone (Comfort mode)	0: Fan OFF 1: Fan speed 1 Heat / Cool 2: Fan speed 1 Cool only	0
	Functionality of X1	0: --- No function 1: Ext / Return Temp (AI) 2: H/C changeover (AI/DI) 3: Window open detect (DI) 4: Dew point sensor (DI)	3
	Functionality of X2	5: Enable electr. Heater (DI) 6: Fault input (DI) 10: Presence detection (DI)	1

LCD display	Parameter	Range	Factory setting
	Operating action of X1	Normal Open (NO) Normal Close (NC)	Normal Open (NO)
	Operating action of X2		
	-	End of wizard	-

If more details are required about parameters, refer to basic documentation P3174.

Reset

To re-load the factory settings for all parameters, set the parameter P71 to **ON**. Restart the thermostat after reset. All LCD segments flash, indicating that the reset is correct.

3 seconds later, the thermostat is ready for commissioning by qualified HVAC staff.

Compressor-based application

- When the thermostat is used with a compressor, adjust the minimum output on-time (parameter P48) and off-time (parameter P49) for Y1 / Y2 to avoid damaging the compressor or shortening its life due to frequent switching.

Calibrate sensor

- Recalibrate the temperature sensor if the room temperature displayed on the thermostat does not match the room temperature measured (after min. 1 hour of operation). To do this, change parameter P05.

Setpoint and range limitation

- We recommend to review the setpoints and setpoint ranges (parameters P08...P12) and change them as needed to achieve maximum comfort and save energy.

Notes: The functional descriptions for the thermostat can be referred to basic documentation (P3174).

Operation

Room temperature out of range

When the room temperature is out of the measuring range (that is, above 49 °C or below 0 °C), - - - will be displayed.



In addition, the heating output is activated if the current setpoint is not set to "OFF", the thermostat is in heating mode and the temperature is below 0 °C.

For all other cases, no output is activated.

The thermostat resumes Comfort mode after the temperature returns to the measuring range.

The following pages can be displayed by touching the  icon, depending on priority: alarm/service reminder, manual H/C changeover, basic Information about room.

Alarm/Service reminder

If any alarm is displayed (), touch the  icon to check the alarm or service reminder.

If there is more than one alarm, use  /  to browse through all active alarms.



The following table describes the detail information for all alarms and services.

Alarm/service	Display	Error code	Type
Condensation	Con	4930	Fault
Ext fault input 1	AL1	9001	Fault
Ext fault input 2	AL2	9002	Fault
Clean filter reminder (+/- to remove reminder)	FIL	3911	Service
Internal sensor error	Er1		Fault
EEPROM error	Er2		Fault
Floor heating sensor error	Er3		Fault

Heating/cooling manual changeover

If manual heating/cooling changeover is set using P01 = 2, touch the  icon once or twice (depending on the alarms) to select heating or cooling mode.

The selected control sequence will start in three seconds.



Disposal



The device is considered electrical and electronic equipment for disposal in terms of the applicable European Directive and may not be disposed of as domestic garbage.

- Dispose of the device through channels provided for this purpose.
- Comply with all local and currently applicable laws and regulations.

Technical data

⚠ Power supply	Rated voltage	AC 230 V
	Overtoltage category	III
	Frequency	50/60 Hz
	Power consumption	Max. 6.0 VA / 2.1 W
Caution ⚠	No internal fuse! External preliminary protection with max C 10 A circuit breaker required in all cases.	
Outputs	Fan control Q1, Q2, Q3-N	AC 230 V
	Rating min, max resistive (inductive)	Min. 5 mA, Max. 5(2) A
⛔ Note!	Fans must NOT be connected in parallel! Connect one fan directly, for additional fans, one relay for each speed.	
	Control output Y1-N / Y2-N (NO)	AC 230 V
	Rating Min, Max resistive (inductive)	Min. 5 mA, Max. 5(2) A
	Max. total load current through terminal "L" (Qx+Yx)	Max. 7 A
Caution ⚠	No internal fuse! External preliminary protection with max C 10 A circuit breakers in the supply line required in all cases.	
Inputs	Multifunctional input X1-M / X2-M	
	Temperature sensor input:	
	Type	See "Equipment combinations"
	Temperature range	0...49 °C
	Cable length	Max. 80 m
	Digital input:	
	Operating action	Selectable (NO / NC)
	Contact sensing	SELV DC 0...5 V / Max. 5 mA
	Parallel connection of several thermostats for one switch	Max. 20 thermostats per switch
	Insulation against mains voltage (SELV)	4 kV, reinforced insulation
Function of inputs:		
External temperature sensor, heating/cooling changeover sensor, window contact, presence detection, dewpoint monitor contact, enable electrical heater contact, fault contact	Selectable X1: P38 X2: P40	
Operational data	Switching differential, adjustable	
	Heating mode (P30)	2 K (0.5...6K)
	Cooling mode (P31)	1 K (0.5...6K)
	Setpoint setting and range	
	☀ Comfort (P08)	21 °C (5...40 °C)
	☾ Economy (P11-P12)	15 °C / 30°C (OFF, 5...40 °C)
	⊞ Protection (P65-P66)	8 °C / OFF (OFF, 5...40 °C)
	Multifunctional input X1/X2	
	Input X1 default value (P38)	3 (Window contact)
	Input X2 default value (P40)	1 (External temperature sensor)

	Built-in room temperature sensor	
	Measuring range	0...49 °C
	Accuracy at 25 °C	< ± 0.5 K
	Temperature calibration range	± 3.0 K
	Settings and display resolution	
	Setpoints	0.5 °C
	Current temperature value displayed	0.5 °C
Environmental conditions	Storage	As per IEC 60721-3-1
	Climatic conditions	Class 1K3
	Transport	As per IEC 60721-3-2
	Climatic conditions	Class 2K3
	Operation	As per IEC 60721-3-3
	Climatic conditions	Class 3K5 ¹⁾
Standards and directives	EU Conformity (CE)	A6V11174840 ^{*)}
	RCM conformity to EMC emission standard	A6V11174927 ^{*)}
	Safety class	II as per EN 60730
	Pollution class	Normal
	Degree of protection of housing	IP 30 as per EN 60529
	Housing flammability class according to UL94	V-0
Environmental compatibility	The product environmental declaration A6V11171690 ^{*)} contains data on environmentally compatible product design and assessments (RoHS compliance, materials composition, packaging, environmental benefit, disposal).	
General	Connection terminals	Solid wires or prepared stranded wires 1 x 0.4...1.5 mm ²
	Minimal wiring cross section on L, N, Q1, Q2, Q3, Y1, Y2	Min 1.5 mm ²
	Housing front color	Ivory White
	Weight without / with packaging	0.155 kg / 0.255 kg

^{*)} The documents can be downloaded from <http://siemens.com/bt/download>.

¹⁾ No condensation is allowed.

Connection terminals

RDF800, RDF800/NF	L, N	Operating voltage AC 230 V
	Q1	Control output "Fan speed 1 AC 230 V"
	Q2	Control output "Fan speed 2 AC 230 V"
	Q3	Control output "Fan speed 3 AC 230 V"
	Y1, Y2	Control output "Valve" AC 230 V (N.O., for normally closed valves), output for compressor or output for electrical heater
	X1, X2	Multifunctional input for temperature sensor (such as QAH11.1) or potential-free switch Factory setting: X1 = Window contact X2 = External sensor (function can be selected via parameter P38 / P40)
	M	Measuring neutral for sensor and switch

Connection diagrams

Application

2-pipe / heating or cooling – ON/OFF

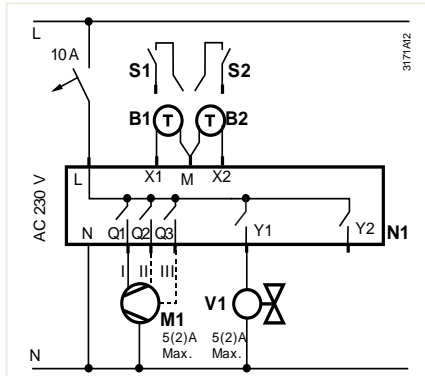

- N1 Room thermostat RDF800...
- M1 1- or 3-speed fan
- V1 Valve actuator, 2- or 3-position
- V1, V2 Valve actuator, 2-position
- E1 Electric heater
- C1, C2 1-stage compressor
- S1, S2 Switch (keycard, window contact, presence detector, etc.)
- B1, B2 Temperature sensor (return air temperature, external room temperature, changeover sensor, etc.)
- X1, X2 Inputs

2-pipe, / heating or cooling – 3-position
 – Y1 = Open
 – Y2 = Close



2-pipe and el. heater/
 Heating or cooling and el. heater

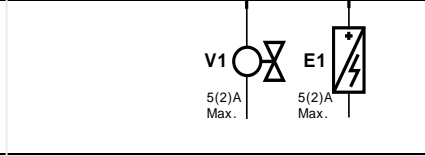

4-pipe / Heating and radiator
 – V1 = Heating
 – V2 = Cooling

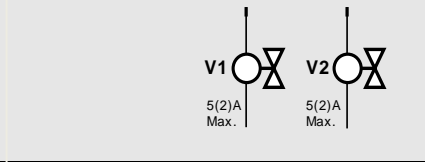

1-stage compressor
 – C1 = Heating and / or
 – C2 = Cooling

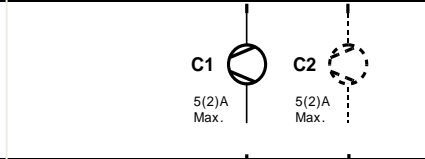

1-stage compressor and electric heater

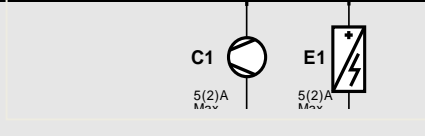

Example1: With SUA21/3
 2-pipe fan coil application

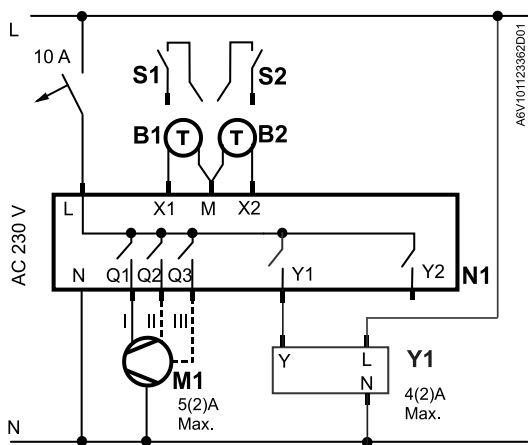

Example2: With SUA21/3
 4-pipe fan coil application

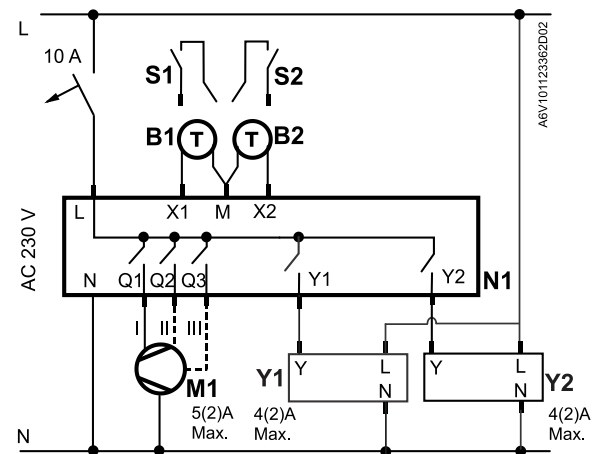

Dimensions (mm)

RDF800/NF
for square conduit
boxes only

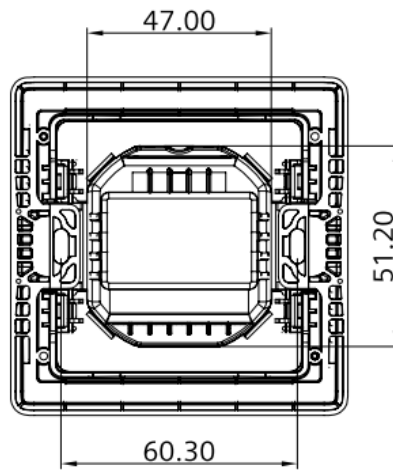
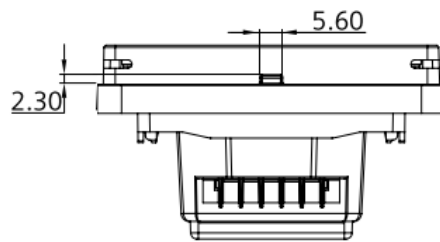
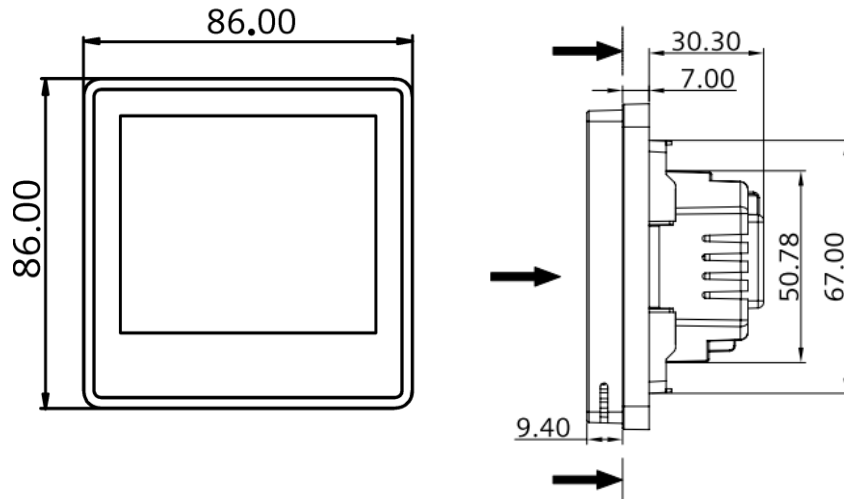

ARG800.1 Single
Mounting Frame for
RDF800/NF

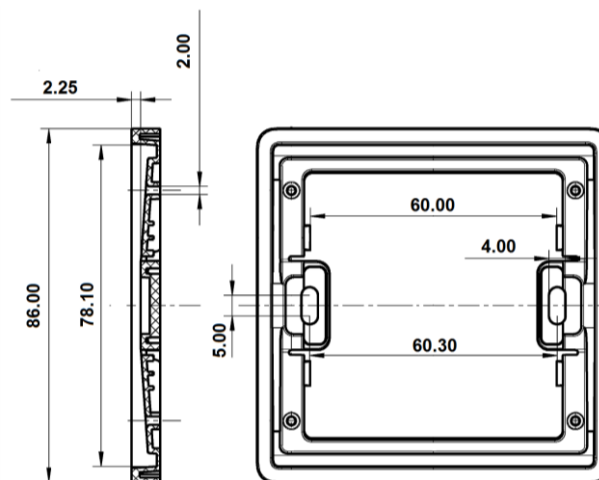

RDF800
for round
conduit boxes

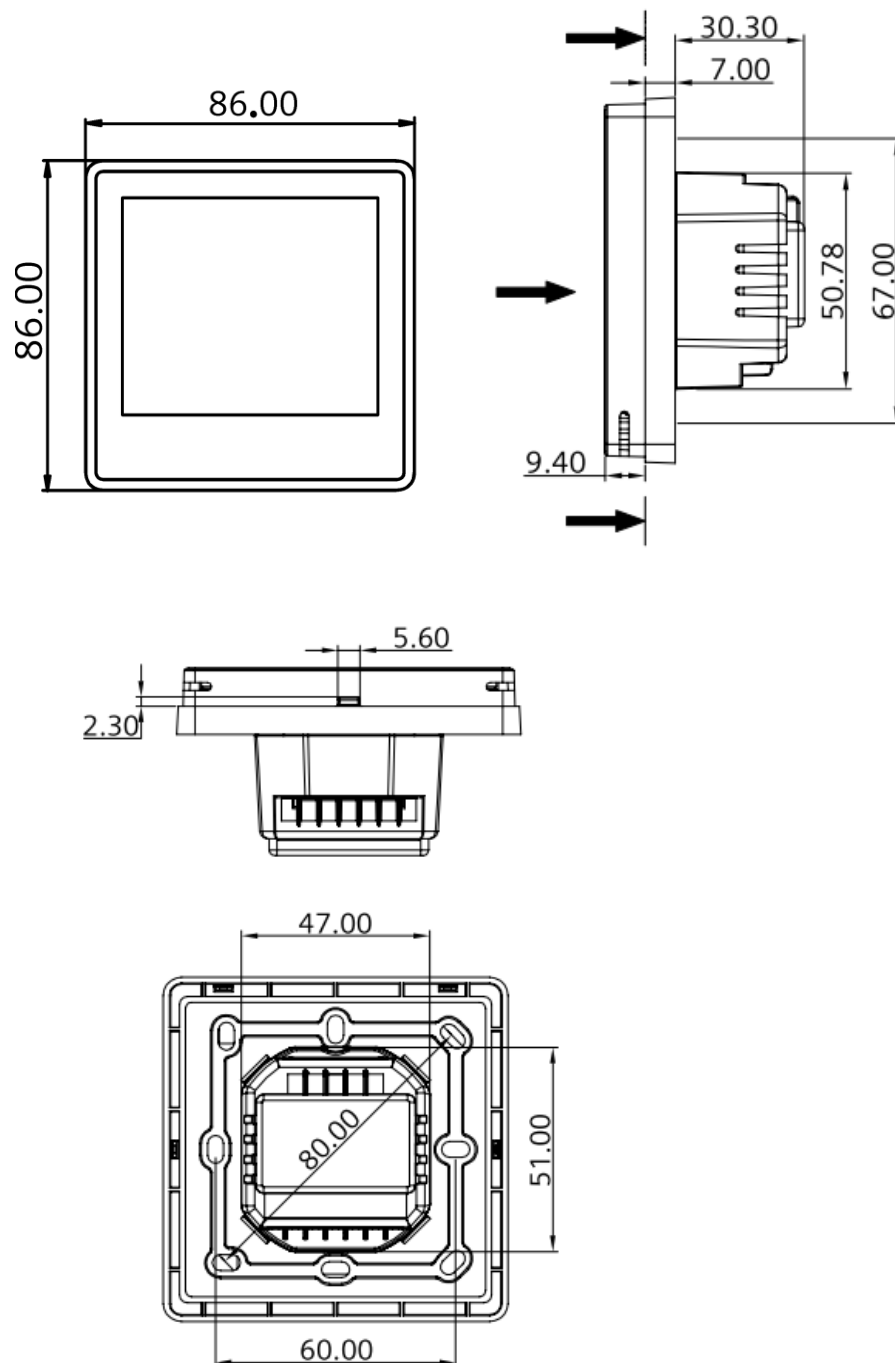

Issued by
Siemens Switzerland Ltd
Smart Infrastructure
Global Headquarters
Theilerstrasse 1a
CH-6300 Zug
Tel. +41 58 724 2424
www.siemens.com/buildingtechnologies

© Siemens Switzerland Ltd., 2019
Technical specifications and availability subject to change without notice.