

Synco™ 100

Room Temperature Controller

RLA162

with 2 outputs DC 0...10 V

Room temperature controller for basic ventilation, air conditioning and heating plants. Compact design with 2 analog control outputs DC 0...10 V for heating and/or cooling.

Use

Plant types:

- Small ventilation or air conditioning plants with own air handling section
- Small heating plants
- Heating section of larger ventilation or air conditioning plants
- Ventilation zones of ventilation or air conditioning plants with central air handling

Building types:

- Small residential buildings
- Non-residential buildings of all types
- Apartments with a suitable reference room
- Individual rooms (e.g. conference rooms, training centers)
- Devices that can be controlled:
 - Heating valve actuators
 - Cooling valve actuators
 - Air damper actuators
 - Current valves of electric air heater batteries

Functions

Main function

- Control of the room temperature through modulating control of the actuating device on the water- or air-side with selectable operating action of the control signals for heating only or cooling only or heating and cooling

Other functions

- Outside temperature compensation
- Minimum limitation of the supply air temperature
- Setpoint changeover via external contact
- Test mode as a commissioning aid

Ordering

When ordering, please give the type reference **RLA162**

Equipment combinations

Actuators and controls must meet the following specification:

- Control input: modulating, DC 0...10 V
- Operating voltage: AC 24 V

For auxiliary functions, the following products can be used:

<i>Type of unit</i>	<i>Type ref.</i>	<i>Data Sheet</i>
Air duct temperature controller (as a minimum limiter)	RLM162	N3332
Outside sensor (for outside temperature compensation)	QAC22	N1811

Technical design

Temperature control

Application

- 1-stage heating
- 1-stage cooling
- 2-stage heating
- 1-stage heating and 1-stage cooling

Settings

The following settings are required:

- Room temperature setpoint: to be adjusted with the setting knob which can be accessed by the user
- Operating action: the 2 control outputs Y1 and Y2 can act as follows:
 - 1-stage heating: control output Y2 is not used
 - 1-stage cooling: control output Y2 is not used
 - 2-stage heating: both control outputs have the same operating action and operate in sequence
 - 1-stage heating and 1-stage cooling: the control outputs have opposed operating actions; the dead zone is fixed at 1.5 K
- Control mode: P or PI; with PI mode, the integrated action time is fixed at 600 seconds
- P-band: the P-band of control output Y1 is adjustable.
For Y2, the following applies:
 - With operating action **Heating**, the P-band of Y2 is identical to the P-band of Y1
 - With operating action **Cooling**, the P-band of Y2 is 50 % of the P-band of Y1

Control

The RLA162 temperature controller compares the room temperature acquired by the sensor (integrated in the controller) with the setpoint. If there is a deviation, the controller generates a DC 0...10 V control signal to adjust the regulating unit(s) between 0...100 %.

In P-mode, the output is proportional to the offset, in PI mode the output is proportional to the heating or cooling load.

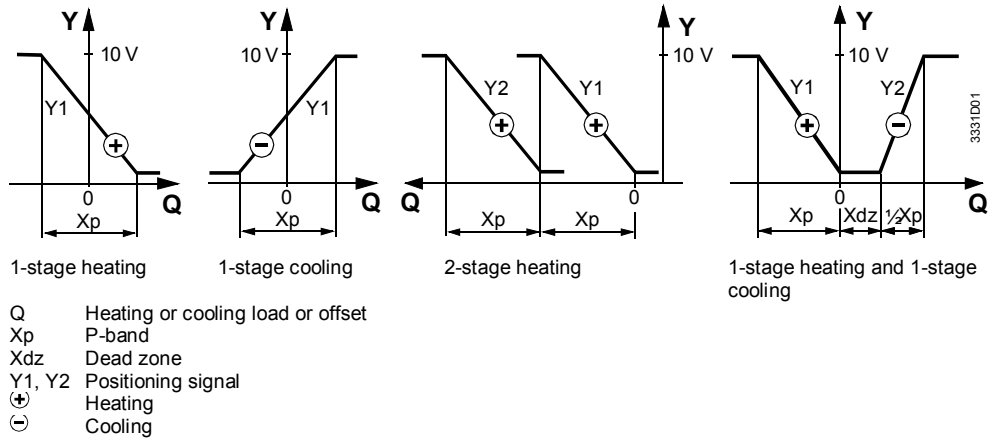

Outside temperature compensation

When using an outside sensor, the current setpoint will be shifted depending on the outside temperature. A choice of 2 ranges is available: LOW or HIGH. Within the selected range, compensation is based on fixed values. Depending on the operating action, compensation operates as follows:

Winter compensation

Winter compensation (**operating action Heating**):

If the outside temperature falls from 5 °C to 0 °C, the setpoint will be continuously raised by 2 K (LOW) or 4 K (HIGH). Below an outside temperature of 0 °C, the temperature increase will be kept constant

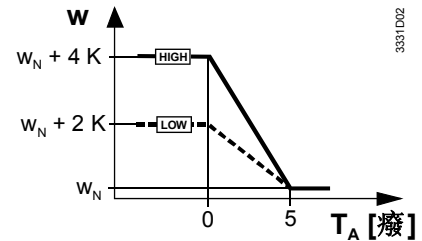

Summer compensation

Summer compensation (**operating action Cooling**):

If the outside temperature rises from 22 °C to 35 °C, the setpoint will be continuously raised by 5 K (LOW) or 10 K (HIGH). Above an outside temperature of 35 °C, the temperature increase will be kept constant

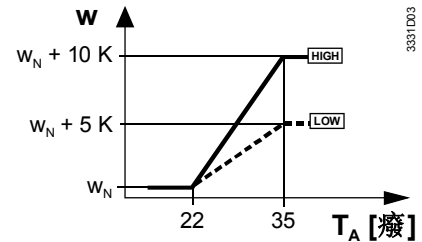

TA Outside temperature
 w Current setpoint
 wN Nominal setpoint

Setpoint changeover

Changeover of the nominal setpoint can be accomplished by closing an external potential-free contact across terminals D1–GND, aimed at saving energy.

- Operating action **Heating**: the nominal setpoint will be **lowered**
- Operating action **Cooling**: the nominal setpoint will be **raised**

Examples:

- Night setback; changeover provided by a time switch
- Setback during non-occupancy times; changeover provided by a presence detector

A **potentiometer** is provided to set the temperature by which the nominal setpoint shall be lowered or raised. This setting is not accessible by the user.

Minimum limitation of the supply air temperature

Minimum limitation of the supply air temperature is accomplished by using an air duct temperature controller RLM162. In this case, the RLM162 delivers its control signal of DC 0...10 V to terminal Z9 of the RLA162. If there are significant heat gains in the reference room, minimum limitation prevents the supply air temperature from falling below a certain level.

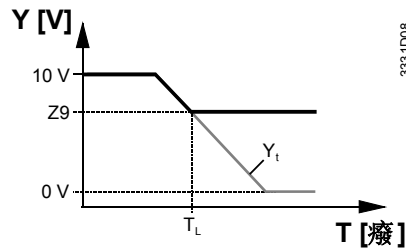

1-stage heating

Minimum limitation of the controlled temperature

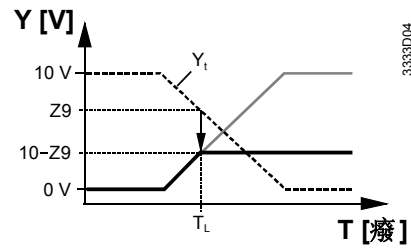

1-stage cooling

Minimum limitation of the controlled temperature through maximum limitation of the output for cooling

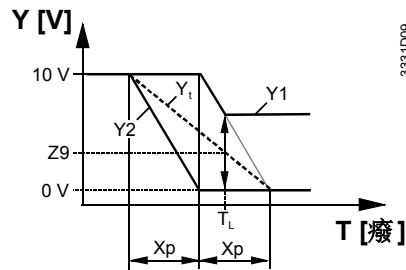

2-stage heating

Minimum limitation, acting on Y1 and Y2

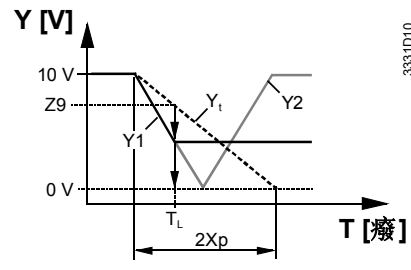

1-stage heating and 1-stage cooling

Minimum limitation, acting on Y1 and Y2

- T Controlled temperature
- T_L Limit temperature
- X_p P-band
- Y Positioning signal of controller
- Y_t Simulated positioning signal
- Z9 Signal delivered by the limiter to terminal Z9

Test mode

In test mode, the control is switched off. The setpoint setting knob acts as a positioning unit to manually drive the actuating device (or both actuating devices) to any position required. The positioning range in test mode is configured to match the selected operating mode. The test mode is indicated by an LED.

Mechanical design

The controller consists of mounting base and plastic housing.

The front carries the setting knob; the mounting base carries the screw terminals and is suited for direct wall mounting or for mounting on a recessed conduit box.

The controller electronics, all internal operating elements and the internal room temperature sensor are located at the rear of the unit.

The following operating elements are provided:

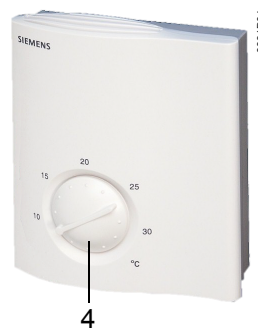
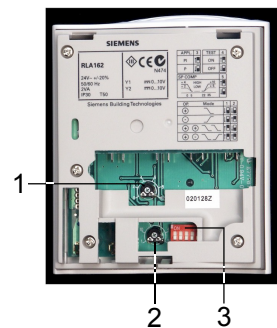

- 1 Setting potentiometer for the setpoint increase or decrease
- 2 Setting potentiometer for the P-band
- 3 Block of DIP switches
- 4 Setting knob for the setpoint

All functions are selected via the DIP switch block which comprises 5 switches:

Function	1	2	3	4	5	Action
Operating mode	<input checked="" type="checkbox"/>	<input checked="" type="checkbox"/>				Heating and cooling in sequence
	<input checked="" type="checkbox"/>	<input checked="" type="checkbox"/>				2-stage heating
	<input checked="" type="checkbox"/>	<input checked="" type="checkbox"/>				1-stage cooling
	<input checked="" type="checkbox"/>	<input checked="" type="checkbox"/>				1-stage heating
Control mode			<input checked="" type="checkbox"/>			PI (integral action time 600 s)
			<input checked="" type="checkbox"/>			P
Test mode				<input checked="" type="checkbox"/>		Test mode
				<input checked="" type="checkbox"/>		Normal operation
Outside temperature compensation					<input checked="" type="checkbox"/>	HIGH
					<input checked="" type="checkbox"/>	LOW

Engineering notes

In the event of a power failure, the actuating device will automatically close or be driven into the neutral position.

The controller is supplied complete with Mounting and Installation Instructions.

Mounting notes

The controller must be fitted on a flat wall. The connecting wires can be run to the controller from a recessed conduit box. Ensure that the local safety regulations are complied with. A suitable mounting location is the inner wall of the space to be heated and/or cooled. Not in niches or shelves, not behind curtains, not above or near heat sources and not exposed to direct solar radiation. Mounting height about 1.5 m above the floor.

To mount the controller, fit the mounting base first. After the electrical connections are made, engage the housing in the base and snap it on.

Commissioning notes

To check the control wiring, the controller can be switched into test mode so that the response of the actuating device can be checked.

If the control is instable, increase the proportional band; if it is too slow, decrease the proportional band.

If the reference room is equipped with thermostatic radiator valves, they must be set to their fully open position and then fixed.

Disposal

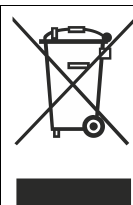

The device is considered electrical and electronic equipment for disposal in terms of the applicable European Directive and may not be disposed of as domestic garbage.

- Dispose of the device through channels provided for this purpose.
- Comply with all local and currently applicable laws and regulations.

Technical data

Power supply

Operating voltage	AC 24 V \pm 20 %
Frequency	50 / 60 Hz
Power consumption	max. 2 VA

Functional data	Setting range nominal setpoint	8...30 °C
	Setting range setpoint changeover	0...10 K
	P-band	1...50 K
	Integral action time with PI control	600 s
	Dead zone with heating and cooling in sequence	1.5 K
	Control outputs Y1, Y2	
	Voltage	DC 0...10 V, continuous
	Current	max. 1 mA
	Max. cable length copper cable 1.5 mm ²	
	For signal input B9	80 m
For switching input D1	80 m	
Contact sensing (input D1-M)	DC 6...15 V, 3...6 mA	
Environmental conditions	Operation	
	Climatic conditions	to IEC 721-3-3, class 3K5
	Temperature	0...+50 °C
	Humidity	<95 % r.h.
	Transport	
	Climatic conditions	to IEC 721-3-2, class 2K3
	Temperature	-25...+70 °C
	Humidity	<95 % r.h.
	Mechanical conditions	class 2M2
	Norms and standards	EU Conformity (CE)
RCM Conformity		CE1T3330en_C1*)
Product standards		
Automatic electrical controls for household and similar use		EN 60 730-1 and EN 60 730-2-9
Electromagnetic compatibility		
Emissions		EN 50081-1
Immunity		EN 50082-1
Degree of protection		IP 30 EN 60 529
Safety class		II to EN 60 730
Degree of contamination		normal
General	Connection terminals for solid wires or stranded wires	2 × 1.5 mm ² or 1 × 2.5 mm ²
	Weight	0.25 kg

*) The documents can be downloaded from <http://siemens.com/bt/download>.

Connection terminals

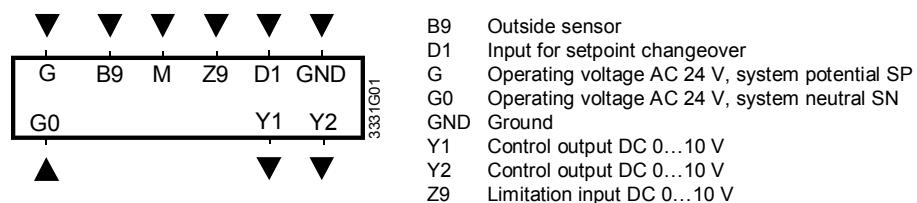

Connection diagrams

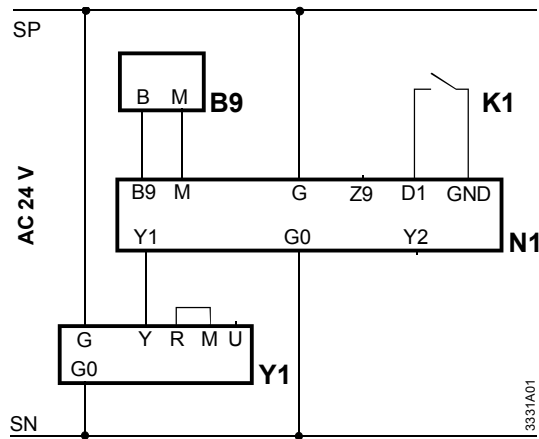

Room temperature control with outside temperature compensation and setpoint change-over

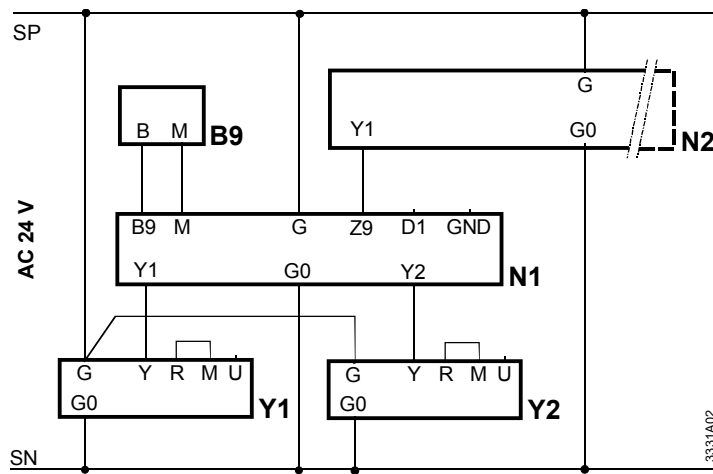

Room temperature control with heating and cooling, outside temperature compensation and minimum limitation of the supply air temperature

- B9 Outside sensor QAC22
- K1 External switch (e.g. of a time switch)
- N1 Room temperature controller RLA162
- N2 Air duct temperature controller RLM162 (as a limiter)
- Y1 Heating valve actuator
- Y2 Cooling valve actuator

Application examples

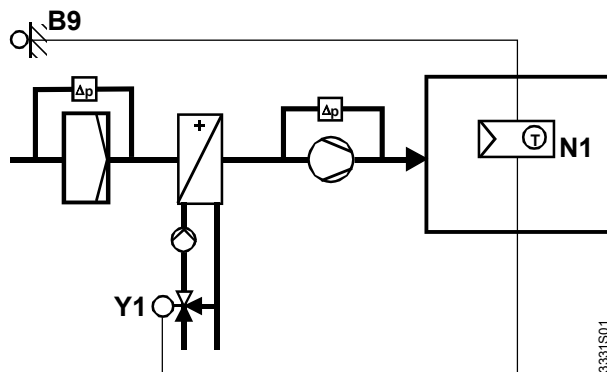

Room temperature control through control of the heating valve, with outside temperature compensation

