

Thermostat

Instructions

Contents

- I. Product Overview
- II. Technical Data
- III. Selection Table
- IV. Buttons
- V. Operating Process of Tools
- VI. Parameter Setup
- VII. Installation Dimension Figure
- VIII. Wiring Diagram
- IX. Installation Instructions
- X. Malfunction Disposal
- XI. Cautions
- XII. After-sale Service

SIZE:86*86*13 MM

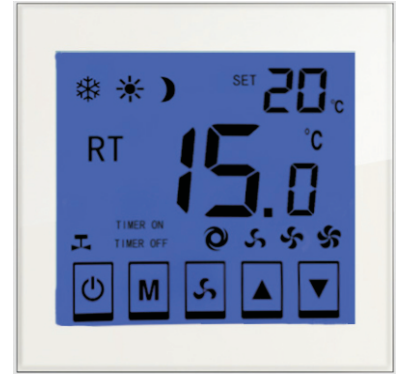

[I. Product Overview]

These kinds of digital thermostats, applying the most advanced and international standardized microcomputer control chip, measures the indoor temperature by the in-built NTC high-precision sensor. It can always compare with the setting temperature, and automatically regulate the heating/cooling air input or switch on/off the motorized valve, so as to keep room in a certain temperature.

[II. Technical Data]

Working voltage: AC220V±10%, 50/60Hz
 Max resistive current: <3A
 Power self-consumption: <1.5W
 Temperature Accuracy: ±1°C
 Timing error: <1%
 Output rated power: <200W
 Temperature setup range: 5°C - 35°C

[III. Alternative Working Modes Table]

A: Control the fan coil and motorized valve synchronously (The fan stops as the motorized stops when the temperature reaches the set value.)
 B: Control the fan coil and motorized valve. Asynchronously (the fan goes on working as the motorized valve stops when the temperature reaches the set value.)

1

T: Have clock or timing power ON/OFF function.
 Y: Have remote control function, if it is blank, it means thermostats do not have this function.
 L: Have backlight function, if it is blank, it means thermostats do not have this function

[IV. Buttons]

“⏻” - Power on/off;
 “⏸” - Wind speed adjustment;
 “⏺” - Mode;
 “▲” - Set temperature rise or adjust the set value of work mode
 “▼” - Set temperature drop or adjust the set value of work mode

[V. Operating Process of Tools]

1. Temperature setting

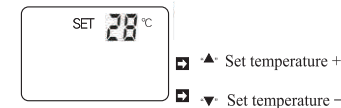

2

2. Cooling/Heating Setup

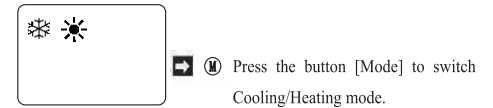

3. Wind Speed Setup

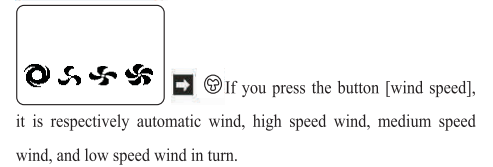

In the state of automatic wind, thermostats will compare the indoor room temperature with the temperature setting point, and automatically adjust the wind speed of fan, no need for manual regulation.

3

4. Timing power OFF Setup

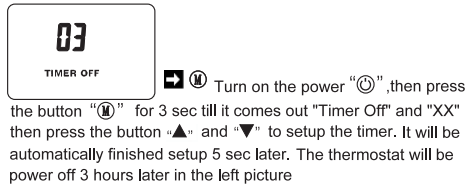

5. Timing power ON Setup

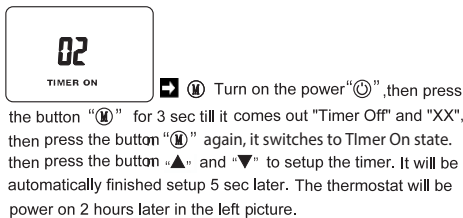

[VI. Parameter Setup]

Button lock mode: Turn on the controller, then keep pressing “▲” and “▼” until it displays “🔒” on the screen.

4

Temperature limiting mode: Turn on the controller, then keep pressing “⏺” and “▲” until it displays “h”.
 During Turn-Off status, press “⏸” button for 5 seconds to access to Senior Parameter Setup. Then press the button “⏸” again, it switch to the next menu. In the parameter setup state, press the buttons “▲” or “▼” to setup the value.

NO.	Items	Description	Default
01	TEMP calibration:	Range: from -9°C to 9°C	-1°C
02	Activated temp difference	Range: from -1°C to 5°C We set it 2°C and the setup temp 25 In heat mode, if the room temp is 24 fan not work. If the room temp is 23°C, fan start to work.	1°C
03	Fan working way	1: fan stops when it reaches setup temp 0: fan keeps running when it reaches temp. In auto fan mode, fan runs at speed when it reaches the setup	1
04	Protection of low-temp	0: open 1: close In heat mode, if room temp <5°C, fan and valve start working automatically.	1
05	Cool limit of temp setup	Range: from 10°C to 30°C	25°C
06	Heat limit of temp setup	Range: from 10°C to 30°C	20°C

5

[VII. Installation Dimension Figure]

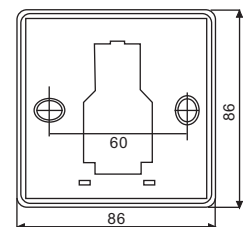

size 86x86mm

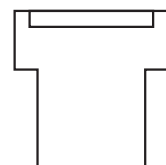

Power box size 64x64x26mm

6

[VIII. Wiring Diagram]

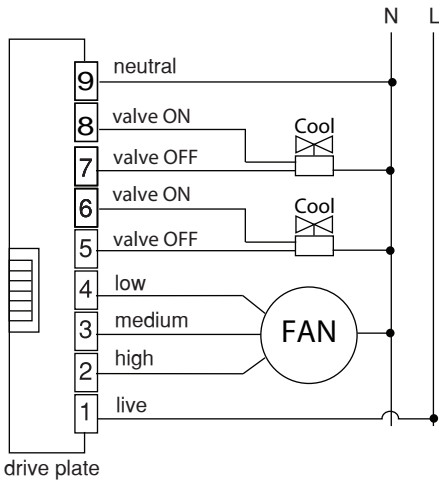

7

[IX. Installation Instructions]

Please follow the instructions to make the correct installation.

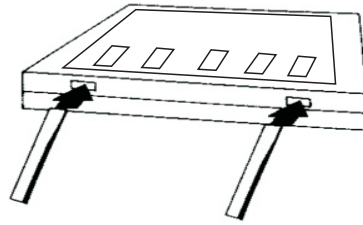

Step 1: Open the control board: use a 3.5mm wide screwdriver along the bevel into the slot for 4 mm.

8

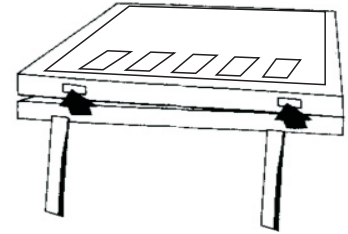

Step 2: Slightly upward prize it to open hook.

9

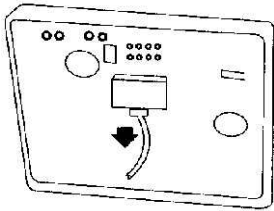

Step 3: Remove the Cable.

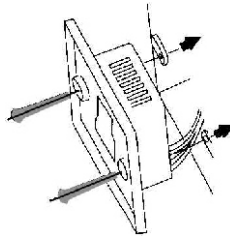

Step 5: Fix it with two screws in the packaging box.

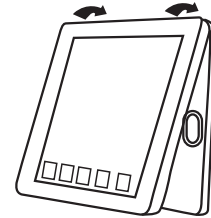

Step 7: Hang the two pothooks in 30-degree angle, must hang them in place.

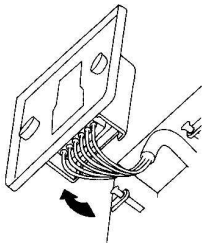

Step 4: Connect wire.

10

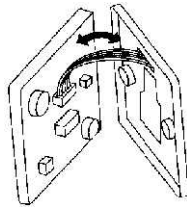

Step 6: Install the control board wire.

11

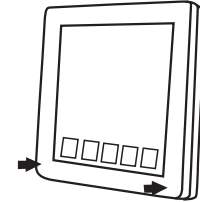

Step 8: Slightly press the underside corners, block the shell and accomplish the installation.

12

[X. Malfunction disposal]

Statement: Only professional technical personnel can maintain the products of our company.

Malfunction	Disposal
Boot-strap error	<ul style="list-style-type: none"> ★ Check L.N power and the wiring connection ★ Check the power on/off button; ★ Change the control board, or change the power supply board ★ Check the connection of wiring between the control board and the power supply board
LCD garbled	<ul style="list-style-type: none"> ★ The back shell may be deformed during the installation loose the two fixation screws
No output with right display	<ul style="list-style-type: none"> ★ Power control panels and connecting cable may be damaged ★ Change the control board and then change the power plate
Remote failure	<ul style="list-style-type: none"> ★ Check whether there is a remote battery power ★ Change the remote
Temperature display abnormal.	<ul style="list-style-type: none"> ★ The temperature hasn't been calibrated.

[XI. Cautions]

- ★ Please connect wires in strict compliance with the installation wiring diagram;
- ★ Please install a thermostat correctly in strict compliance with the installation diagram
- ★ Do not pull the cable forcibly, or it may be damaged;
- ★ Do not squeeze the LCD or scratch the LCD surface during the installation;
- ★ During the installation, do not knock those electronic components on the circuit board, and do not drop or deform the back cover
- ★ If hard plastic lines are used during the installation, do bend it into a appropriate angle firstly
- ★ Do not drop it into construction mud..

[XII. Warranty Service & Sale Support]

The warranty service is 18 months from date of purchase. The products of our company may enjoy life-long in accordance with the regulations. Our company will make a certain charge to the service out of the warranty period or product quality.