

ACVATIX™

## Electromotoric actuators for valves

SAX..P..



### Actuators with 20 mm stroke and 500 N force

- SAX31P03 Operating voltage AC 230 V, 3-position positioning signal
- SAX61P03 Operating voltage AC/DC 24 V, positioning signal 0...10V, 4...20 mA  
With position feedback, forced control, characteristic changeover
- SAX61P03/MO operating voltage AC/DC 24 V,  
RS-485 for Modbus RTU communication
- SAX81P03 Operating voltage AC/DC 24 V, positioning signal 3-position
- For direct mounting on valves; no adjustments required
- Manual adjuster, position and status indication (LED)
- Optional functions with auxiliary switches, potentiometer

## Use

Electromotoric actuators to operate Siemens combi valves for type series VPF43., VPF44.. and VPF53.. with 20 mm stroke, as control valves on ventilation, air conditioning, district heating and refrigeration plants.

## Functions

Function	Description	Type	
3-position control	A 3-position signal controls the actuator via connection terminals Y1 or Y2. The desired position is transmitted to the valve.	SAX31P03, SAX81P03	
Modulating control	The modulating positioning signal provides stepless motor control. The positioning signal range (DC 0...10 V / DC 4...20 mA / 0...1000 Ω) corresponds to the positioning range (closed...open, or 0...100% stroke) in a linear manner.	SAX61P03	
Positioning signal and characteristic changeover	Setting with DIL switch. Factory setting: <ul style="list-style-type: none"> <li>Characteristic curve: log = Equal percentage (switch set to Off)</li> <li>Positioning signal: DC 0...10 V (switch set to Off)</li> </ul>		
Position feedback U	Signal returned to acquire the position via input.	SAX61 P03, SAX61P03/MO	
Forced control (Z-mode)	Forced control helps override automatic mode and is implemented via higher control.		
Calibration	Carry out during initial commissioning. The actuator drives to the top or bottom end position; the measured values are saved.		
Valve seat detection	The actuators have power-dependent seat detection. After calibration, the exact valve stroke is stored in the actuator's memory.		
Foreign body detection	After clogging is detected, three attempts are made to get past clogging. If unsuccessful, the actuator continues to following the positioning signal only within a limited range, and the LED blinks red.		
Modbus RTU (RS-485), not galvanically isolated	Setpoint 0..100 % valve position Actual value 0...100 % for valve position Override control Open / Close / Min / Max / Stop Setpoint monitoring and backup mode		SAX61P03/MO

## Type summary

Type	Item No.	Stroke	Positioning force	Operating voltage	Positioning signal	Spring return time	Positioning time	LED	Manual adjustment <sup>3)</sup>	Auxiliary functions
SAX31P03 <sup>1)</sup>	S55150-A118	20 mm	500 N	AC 230 V	3-position	-	30 s	-	Push and fix	4)
SAX61P03 <sup>2)</sup>	S55150-A114			AC 24 V DC 24 V	DC ... 10 V DC 4...20 mA 0...1000 Ω			Yes		5) 7)
SAX61P03/MO <sup>2)</sup>	S55150-A143			Modbus RTU						6) 7)
SAX81P03 <sup>2)</sup>	S55150-A116			3-position				-		4)

- 1) Approbation: CE
- 2) Approbation: CE, UL
- 3) Not designed for continuous operation.
- 4) Optional accessories: Auxiliary switch, potentiometer
- 5) Position feedback, forced control, characteristic changeover
- 6) Position feedback, forced control
- 7) Optional accessories: Auxiliary switch, sequence control, control action changeover

### Scope of delivery

Actuators, valves and accessories are supplied in individual packs.

## Accessories/spare parts

### Electrical accessories

Type	Auxiliary switch ASC10.51	Potentiometer ASZ7.5	Function module AZX61.1
Item No.	S55845-Z103	S55845-Z106	S55845-Z107
		Max. 2	
SAX31P..	Max. 2	Max. 1	-
SAX61P..		-	Max. 1
SAX61P../MO			-
SAX81P..		Max. 1	-



### Mechanical accessory

Type	Weather shield ASK39.1
Item No.	S55845-Z109

### Ordering (example)

Type	Stock number	Designation	Number of pieces
SAX81P03	S55150-A116	Actuator	1
ASZ7.5	S55845-Z106	Potentiometer	1

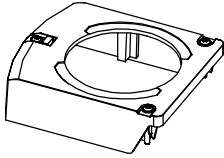
## Spare parts

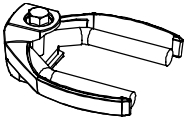
Product number / Stock number	Housing cover	Screw (valve stem coupling)
8000060843		
		

## Equipment combinations

### VPF43..

Valve type			DN	H <sub>100</sub> [mm]	$\dot{V}_{Min.}$ [m <sup>3</sup> /h]	$\dot{V}_{m100}$ [m <sup>3</sup> /h]	$\Delta p_{min}$ [kPa]	Data sheet
Standard flow	VPF43.50F16	S55266-V100	50	20	2.3	15	35	N4315
	VPF43.65F24	S55266-V102	65		4.4	25		
	VPF43.80F35	S55266-V104	80		5.3	34		
High flow rate	VPF43.50F25	S55266-V101	50		4.3	25	70	
	VPF43.65F35	S55266-V103	65		6	35		
	VPF43.80F45	S55266-V105	80		7	43		

### VPF44..

Valve type			DN	H <sub>100</sub> [mm]	$\dot{V}_{Min.}$ [m <sup>3</sup> /h]	$\dot{V}_{m100}$ [m <sup>3</sup> /h]	$\Delta p_{min}$ [kPa]	Data sheet
Standard flow	VPF44.50F15	S55266-V136	50	20	2.9	15.9	25	A6V11466366
	VPF44.65F25	S55266-V138	65		4.0	28.0		
	VPF44.80F35	S55266-V140	80		5.5	36.7		
High flow rate	VPF44.50F25	S55266-V137	50		4.2	26.2	55	
	VPF44.65F35	S55266-V139	65		5.1	35.8		
	VPF44.80F45	S55266-V141	80		7.2	47.9		

### VPF53..

Valve type			DN	H <sub>100</sub> [mm]	$\dot{V}_{Min.}$ [m <sup>3</sup> /h]	$\dot{V}_{m100}$ [m <sup>3</sup> /h]	$\Delta p_{min}$ [kPa]	Data sheet
Standard flow	VPF53.50F16	S55266-V112	50	20	2.3	15	35	N4316
	VPF53.65F24	S55266-V114	65		4.4	25		
	VPF53.80F53	S55266-V116	80		5.3	34		
High flow rate	VPF53.50F25	S55266-V113	50		4.3	25	70	
	VPF53.65F35	S55266-V115	65		6	35		
	VPF53.80F45	S55266-V117	80		7	43		

## Product documentation

Title	Contents	Document ID
Actuators SAX..., SAY..., SAV..., SAL... for valves	Basic documentation: Detailed information on stroke actuators including Modbus types Stroke actuators for valves with 15/20/40 mm stroke and rotary actuators for butterfly valves	CE1P4040en
Electromotoric actuators for valves SA..., Modbus RTU	Data sheet: Modbus communication profiles	A6V101037195
Mounting instructions G..161../MO and S..6/MO	Mounting instructions: Mounting and installation instructions for Modbus actuators	A5W00027551
Valve Actuator DIL Switch Characteristic Overview	Commissioning / Configuration: Describes the characteristics of valve and actuator combinations, it describes the DIL Switch function	A6V12050595

Related documents such as environmental declarations, CE declarations, etc., can be downloaded at the following Internet address:

<http://siemens.com/bt/download>

## Notes

### Safety

	<p><b>⚠ CAUTION</b></p>
	<p><b>National safety regulations</b></p> <p>Failure to comply with national safety regulations may result in personal injury and property damage.</p> <ul style="list-style-type: none"> <li>Observe national provisions and comply with the appropriate safety regulations.</li> </ul>

	<p><b>⚠ WARNING</b></p>
	<p><b>Risk of burns from hot actuator brackets</b></p> <p>The actuator brackets on heating plants can also become hot from the contact with the hot valve during operation. The temperature of the actuator bracket can reach 100 °C.</p> <p>When servicing the actuator:</p> <ul style="list-style-type: none"> <li>Switch off both pump and operating voltage.</li> <li>Close the main shutoff valve in the piping.</li> <li>Allow the piping to cool off.</li> </ul>

**SAX31P03 / SAX81P03**

3-position actuators must be controlled by a controller, see Connection diagrams [→ 15].

**SAX61P03**

Up to 10 actuators can drive in parallel on a controller output with a rating of 1 mA.  
Modulating actuators have an input impedance of 100 kΩ.

**SAX61P03/MO**

The Modbus converter is designed for analog control at 0...10 V.



Keep the analog signal setting on the actuator as is (switch 1 to OFF); adjustment not permitted.

**ASZ7.5**

Actuators with a DC 0...9.8 V feedback signal are recommended for the combination SIMATIC S5/S7 and position feedback.

Signal peaks in potentiometer ASZ7.5 may result in error messages on Siemens SIMATIC. This is not the cause, however, when combined with Siemens HVAC controllers. The reason is the higher resolution and faster reaction time on SIMATIC.

Use the potentiometer as voltage divider on the 3-wire connection. Powering the potentiometer over the wiper may shorten the life cycle of the potentiometer. Signal peaks increase in frequency and scope over the lifespan in this operating mode.

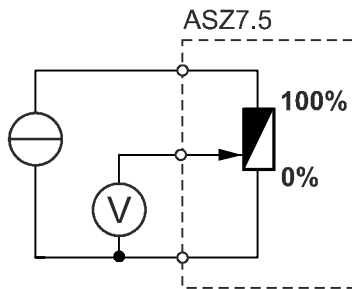

## Mounting

### Mounting positions

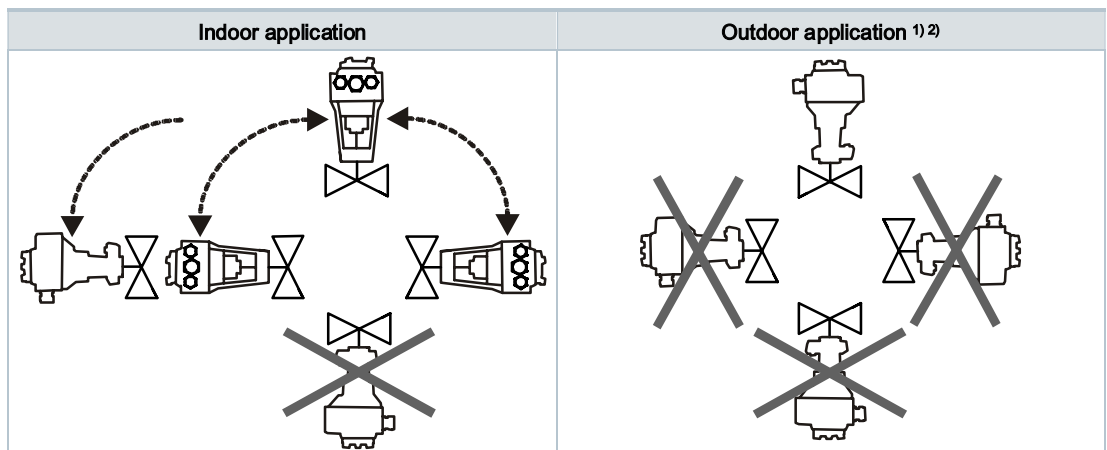

- 1) Only together with weather shield ASK39.2. IP54 housing protection remains unchanged.
- 2) SA../MO is not intended for outdoor use.

## Operation

### Direction of control action

On valves where the stem retracts to the close position, "direct acting" means that the value is fully closed at positioning signal  $Y = 0\text{ V}$  or  $Z = 0\ \Omega$  (i.e. 100 %).

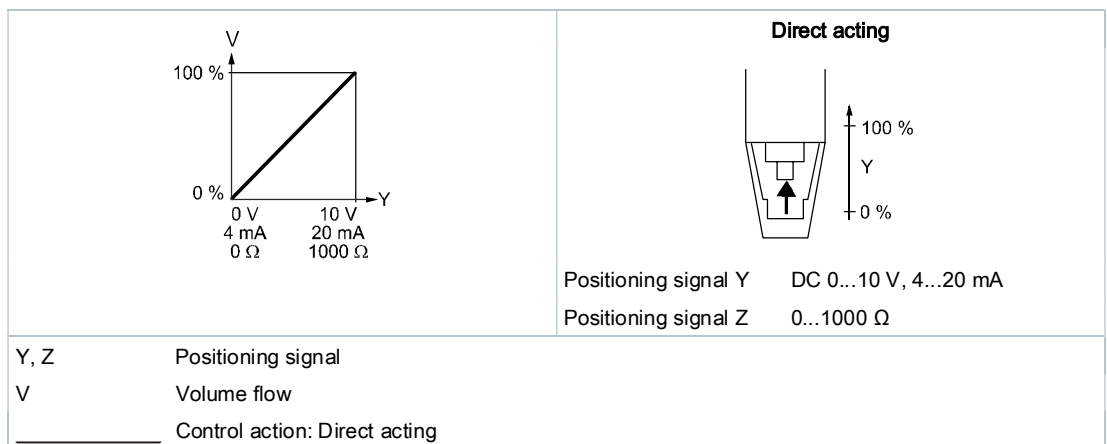

## Maintenance

The actuators are maintenance-free.

## Disposal

---



The device is considered an electronic device for disposal in accordance with the European Guidelines and may not be disposed of as domestic garbage.

- Dispose of the device through channels provided for this purpose.
- Comply with all local and currently applicable laws and regulations.

## Warranty service

Technical data on specific applications are valid only together with Siemens products listed under "Equipment combinations". Siemens rejects any and all warranties in the event that third-party products are used.



## Technical data

Power		
Operating voltage		
SAX31P03		AC 230 V ± 15 %
SAX61P03..		AC 24 V ± 20 % / DC 24 V +20 % / -15 % (SELV / PELV)
SAX81P03		
Frequency		45...65 Hz
External supply line fusing (EU)		<ul style="list-style-type: none"> <li>• Non-renewable fuse 6...10 A slow</li> <li>• Circuit break max. 13 A, tripping characteristic B, C, D to EN 60898</li> <li>• Power source with current limitation of max. 10 A</li> </ul>
Power consumption at 50 Hz		
SAX31P03		6.5 VA / 4 W
SAX61P03	Stem retracts/extends	9.5 VA / 4.5 W
SAX61P03/MO		10.2 VA / 5 W
SAX81P03		7 VA / 4.5 W
Typical inrush current <sup>1)</sup> (3-position actuators)		
SAX31P03		2.3 A
SAX81P03		4.5 A

Operating data	
Positioning times (with the specified nominal stroke)	The positioning time may vary depending on the type of valve (Type summary [→ 3])
SAX31P03, SAX61P03, SAX81P03	30 s
Positioning force	500 N
Nominal stroke	20 mm
Permissible media temperature (valve fitted)	1...120 °C

Signal inputs		
Positioning signal "Y"		
SAX31P03, SAX81P03		3-position
SAX31P03	Voltage	AC 230 V ± 15 %
SAX81P03		AC 24 V ± 20 % / DC 24 V + 20 % / - 15 %
SAX61P03		
DC 0...10 V	Power consumption	≤ 0.1 mA
	Input impedance	≥ 100 kΩ
DC 4...20 mA	Power consumption	DC 4...20 mA ± 1 %
	Input impedance	≤ 500 kΩ

Communication SAX61P../MO		
Communication protocol		
Modbus RTU		RS-485, not galvanically isolated
Number of nodes		Max. 32
Address range		1...248 / 255
	Factory setting	255
Transmission formats		1-8-E-1 / 1-8-O-1 / 1-8-N-1 / 1-8-N-2
	Factory setting	1-8-E-1
Baud rates (kbaud)		Auto / 9.6 / 19.2 / 38.4 / 57.6 / 76.8 / 115.2
	Factory setting	Auto
Bus termination		120 Ω electronically switchable
	Factory setting	Off

Parallel connection	
SAX61P03	≤ 10 (depending on controller output)

Forced control		
Z positioning signal		
SAX61P03		R = 0...1000 Ω, G, G0
	R = 0...1000 Ω	Stroke proportional to R
	Z connected to G	Max. stroke 100 % <sup>2)</sup>
	Z connected to G0	Max. stroke 0 % <sup>2)</sup>
	Voltage	Max. AC 24 V ± 20 % Max. DC 24 V +20% / -15%
	Power consumption	≤ 0.1 mA

Position feedback		
Position feedback U		
SAX61P03		DC 0...10 V
	Load impedance	> 10 kΩ resistive
	Load	Max. 1 mA

Connection cables		
Wire cross-sectional areas		0.75 mm <sup>2</sup> , AWG 20...16 <sup>3)</sup>
Cable entries		
SAX..P..		<ul style="list-style-type: none"> <li>• 2 entries ∅ 20.5 mm (for M20)</li> <li>• 1 entry ∅ 25.5 mm (for M25)</li> </ul>
SAX61P../MO		
	Fixed connection cable	0.9 m
	Number of cores	5 x 0.75 mm <sup>2</sup>

Degree of protection and class		
Housing from vertical to horizontal		IP 54 as per EN 60529 <sup>4)</sup>
Protection class		As per EN 60730
SAX31P03	AC 230 V	II
SAX61P03	AC / DC 24 V	III
SAX81P03		

Environmental conditions			
Operation		IEC 60721-3-3	
	Climatic conditions	Class 3K5	
		Mounting location	Indoors (weather-protected) <sup>4)</sup>
		Temperature, general	-5...< 55 °C
		Humidity (non-condensing)	5...95 % r.h.
Transportation		IEC 60721-3-2	
	Climatic conditions	Class 2K3	
		Temperature	-25...70 °C
		Humidity	< 95% r.h.
Storage		IEC 60721-3-1	
	Climatic conditions	Class 1K3	
		Temperature	-15...55 °C
		Humidity	5...95 % r.h.
Max. media temperature when mounted on valve		120 °C	

Directives and standards		
Product standard		EN 60730-x
Electromagnetic compatibility (field of use)		For residential, commercial, and industrial environments
EU conformity (CE)		CE1T4501X1 <sup>5)</sup>
RCM conformity		CE1T4515X4 <sup>5)</sup>
EAC compliance		Eurasian compliance for all SAX..P..
UL, cUL	AC 230 V	-
	AC / DC 24 V	UL 873 <a href="http://ul.com/database">http://ul.com/database</a> ; file number E35198

Environmental compatibility
Product environmental declarations 71 7331 0559 <sup>5)</sup> und A6V101083254 <sup>5)</sup> include data on environmentally friendly product design and testing (RoHS compliance, material composition, packaging, environmental benefits, disposal).

Dimensions
See Dimensions [→ 17]

Accessories <sup>6)</sup>		
Potentiometer ASZ7.5		0... 1000 Ω ± 5 %
	Voltage	DC 10 V
	Current rating	<4 mA
Auxiliary switch ASC10.51	Switching capacity	AC 24...230 V, 6 (2) A, potential free
External fusing of supply line		<ul style="list-style-type: none"> <li>• Non-renewable fuse 6...10 A slow</li> <li>• Circuit break max. 13 A, tripping characteristic B, C, D to EN 60898</li> <li>• Power source with current limitation of max. 10 A</li> </ul>
US installation, UL & cUL		AC 24 V class 2, 5 A general purpose

- 1) Switching time for RMS value of the sine wave at nominal voltage
- 2) Observe acting direction of DIL switches
- 3) AWG = American wire gauge
- 4) For outdoor operation, always use weather shield ASK39.1, housing protection class IP 54 remains as is. SAX61P../MO is not intended for outdoor use.
- 5) Documents can be downloaded at <http://www.siemens.com/bt/download>
- 6) UL-approved component 

## Connection diagrams

### Internal Diagrams

#### SAX31P03

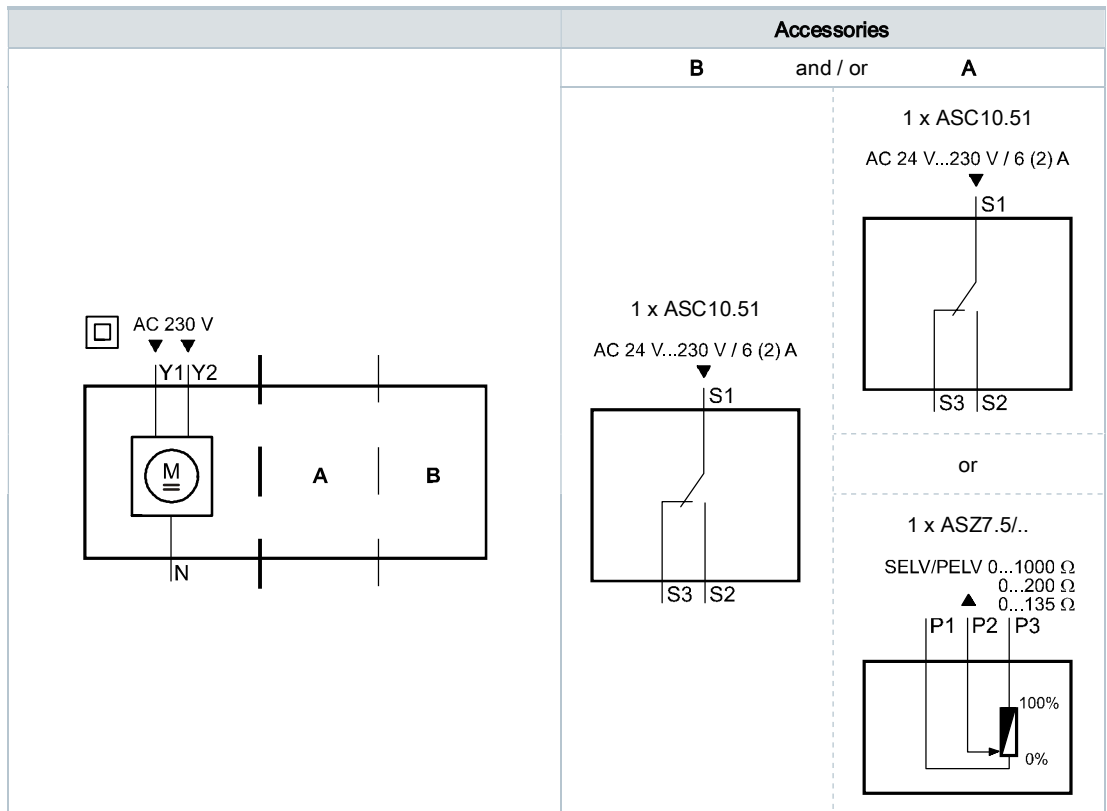

SAX61P..

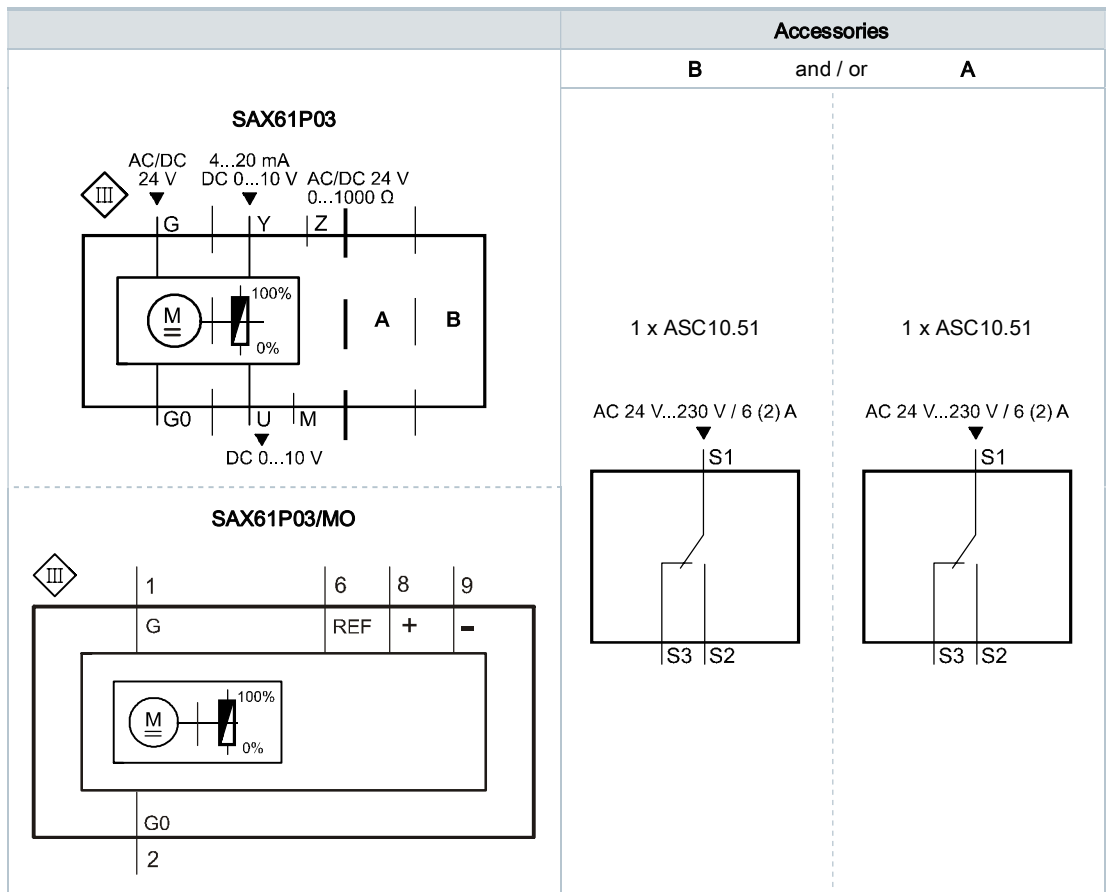

SAX81P03

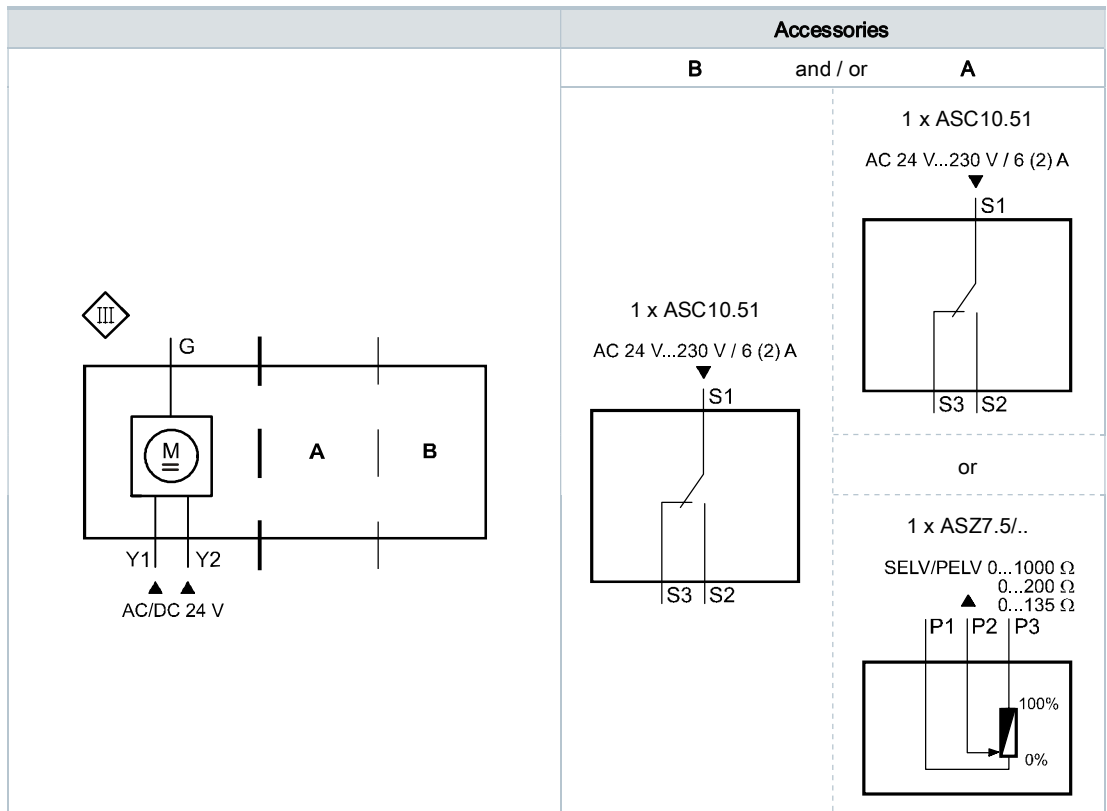

## Connection terminals

### SAX31P03

	AC 230 V	3-position
<b>N</b>	System neutral (SN)	
<b>Y1</b>	Positioning signal (actuator's stem extends)	
<b>Y2</b>	Positioning signal (actuator's stem retracts)	

### SAX61P03

	AC / DC 24 V	D 0...10 V 4...20 mA 0...1000
<b>G0</b>	System neutral (SN)	
<b>G</b>	System potential (SP)	
<b>Y</b>	Positioning signal for DC 0...10 V / 4...20 mA	
<b>M</b>	Measuring neutral	
<b>U</b>	Position feedback DC 0...10 V - (System neutral is measuring ground M)	
<b>Z</b>	Control signal forced control	

### SAX61P03/MO

	AC / DC 24 V	Modbus RTU connecting cable
<b>G0</b>	System neutral (SN)	black
<b>G</b>	System potential (SP) AC 24 V / DC 24 V	red
<b>REF</b>	Reference line (Modbus RTU)	violet
<b>+</b>	Bus + (Modbus RTU)	gray
<b>-</b>	Bus - (Modbus RTU)	pink

### SAX81P03

	AC / DC 24 V	3-position
<b>G</b>	System potential (SP)	
<b>Y1</b>	Positioning signal (actuator's stem extends)	
<b>Y2</b>	Positioning signal (actuator's stem retracts)	

SAX31P03

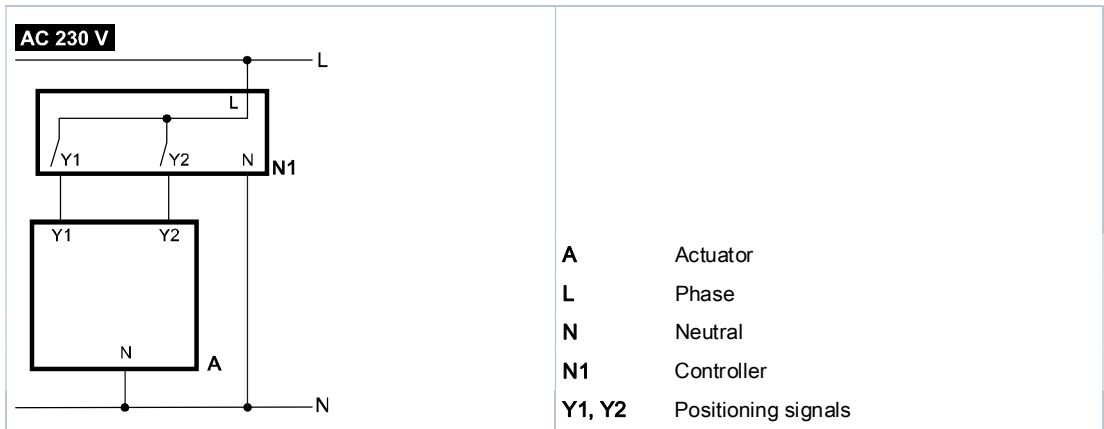

SAX61P03

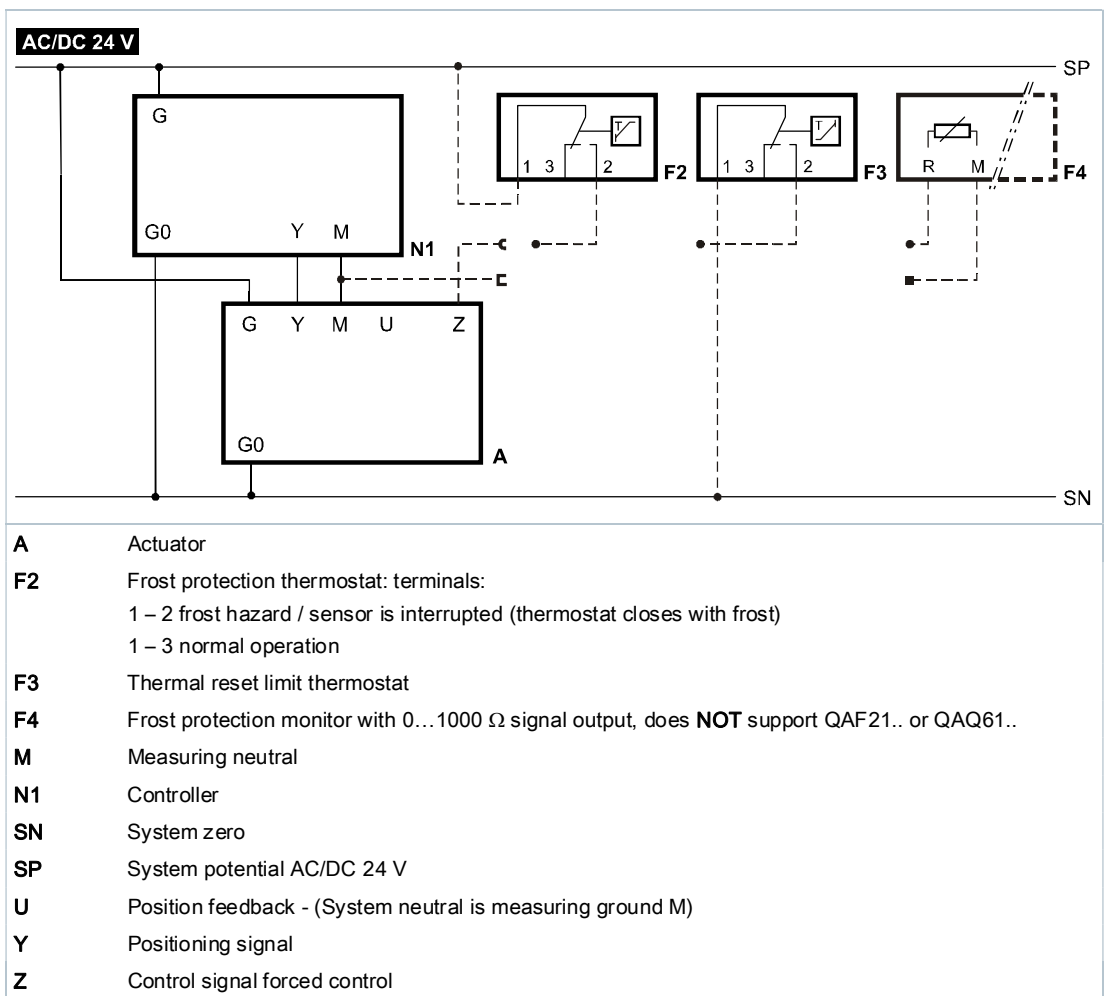

### SAX61P03/MO

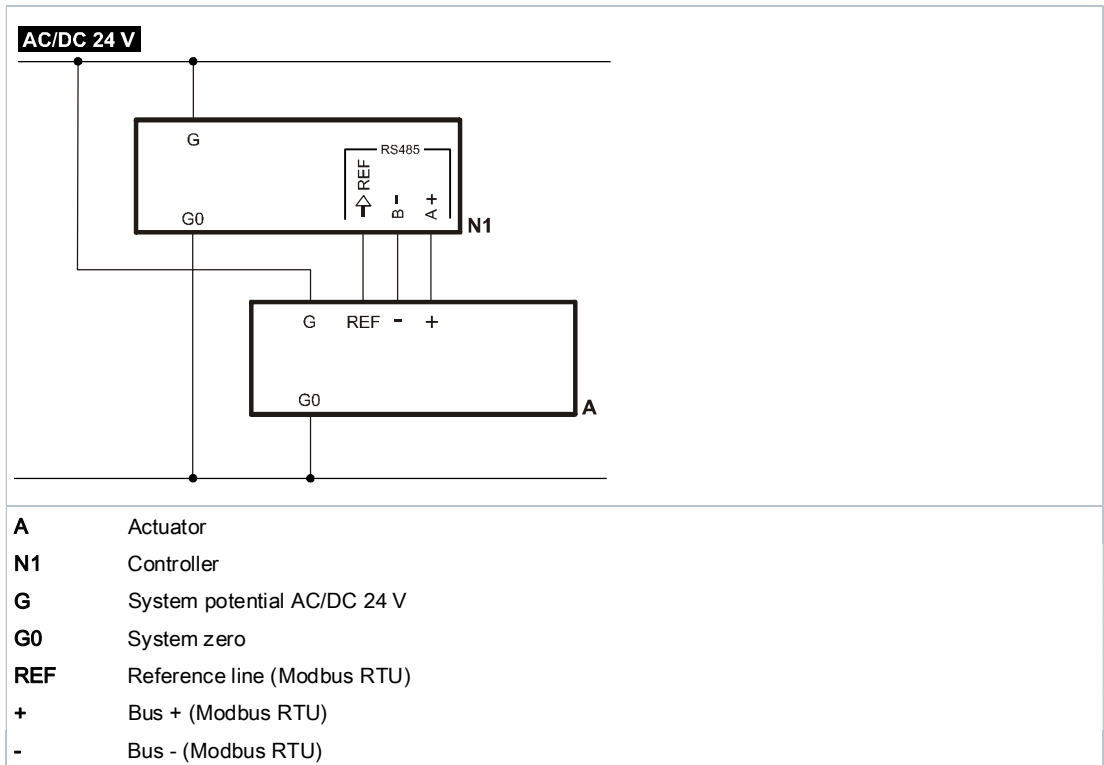

### SAX81P03

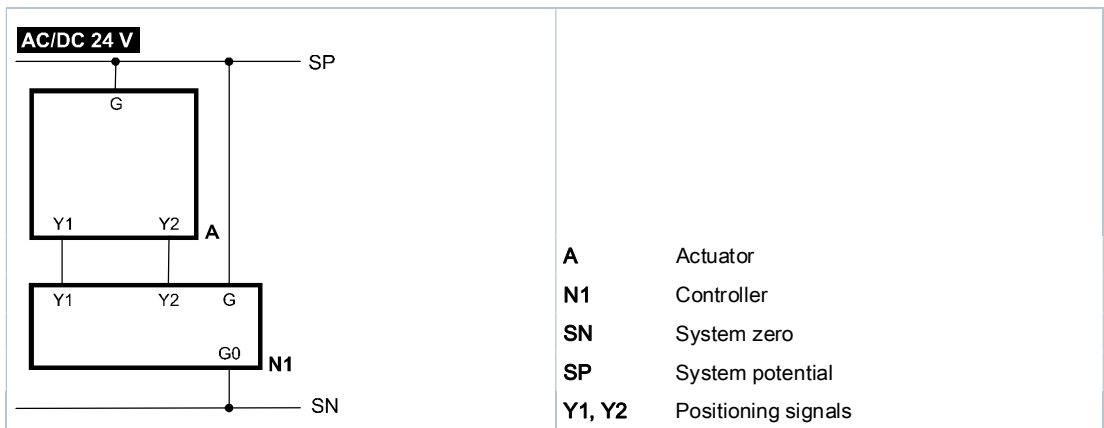



Actuator

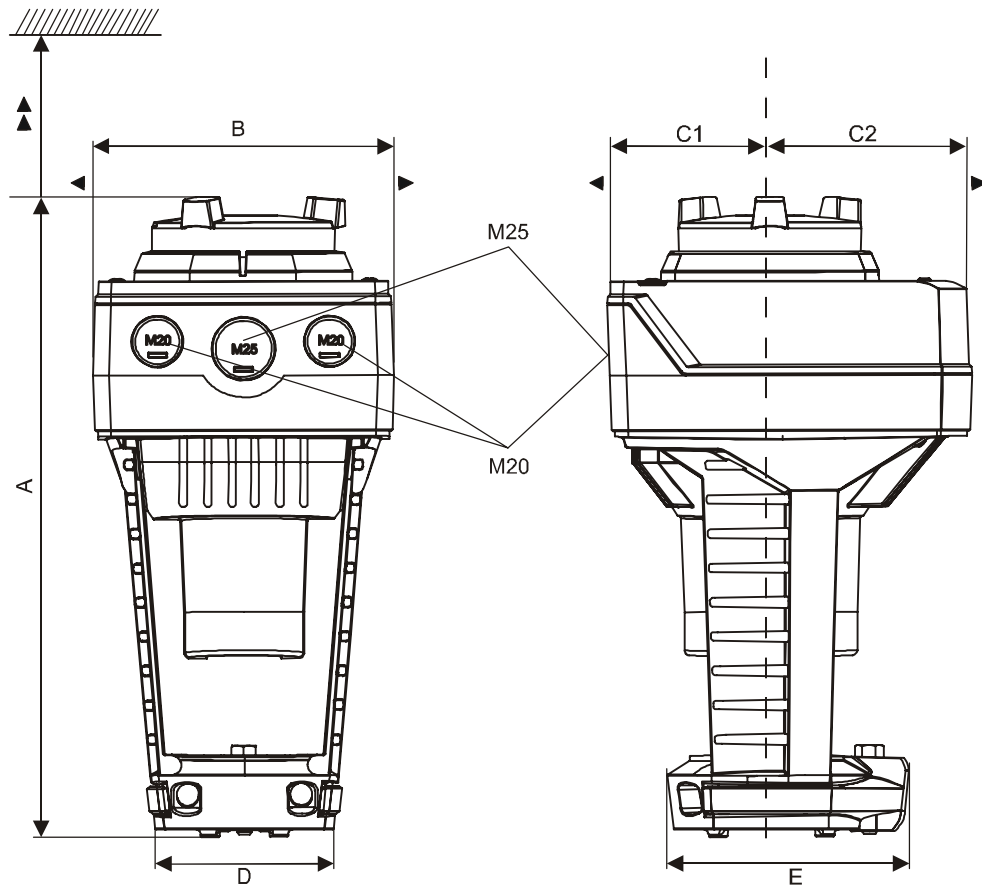

Type	A	B	C	C1	C2	D	E	▶	▶▶	kg
	[mm]									[kg]
SAX..P..	242	124	150	68	82	80	100	100	200	1.780
SAX61P03/MO <sup>1)</sup>										1.930
With ASK39.1	267	154	300	200	100	-			2.010	

<sup>1)</sup> Device has fixed connection cable – left cable entry occupied

## External Modbus converter

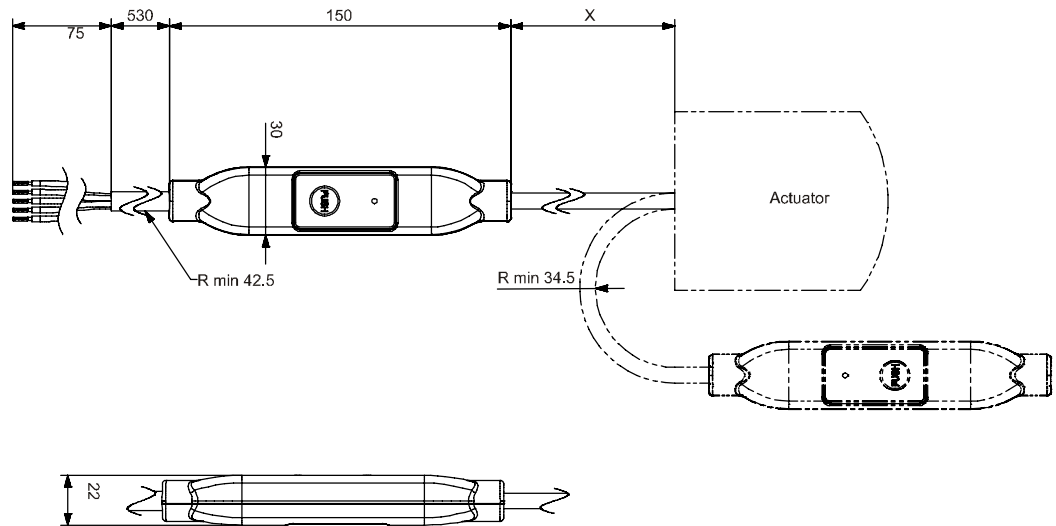

Dimensions in mm

Type	X	kg
	[mm]	[kg]
SAX61P03/MO	250	0.15 <sup>1)</sup>

<sup>1)</sup> Included in total weight.

## Revision numbers

Type	Valid from rev. no.
SAX31P03	..H
SAX61P03	..I
SAX61P03/MO	..B
SAX81P03	..I