



## Humidity & Temp. Transmitters

issue date: 20.Sep.2021, document no: SHW.DS\_v31

### Features

---

- Maintenance free digital micro chip sensing element
- 3%rH accuracy, optional 2%rH
- Temperature options as analog output or passive sensing elements
- Analog outputs as 4-20 mA and 0...10 Vdc
- Operating voltage 24V AC/DC

### Options

---

- Display, custom design
- Modbus RTU, RS485 protocol
- Relay, 1 or 2 relays, can be set individually
- Buzzer, can be set individually
- PID, RTC and Datalogger advanced options for special applications

### Applications

---

- HVAC supply or extract air measuring
- Humidifier or dehumidifier controls
- Pool, greenhouse or hencoop applications
- Air quality applications, measuring and controlling humidity ratio of clean rooms

## Ordering Codes

---

<i>model</i>	<i>accuracy</i>	<i>output 1 - Humidity</i>	<i>output 2 - Temp.</i>	<i>options</i>	<i>advanced options</i>
SHW	3 %rH	0 no output	0 no output	M modbus	P PID out
	2 %rH	1 0...10 Vdc	1 0...10 Vdc	D display	T RTC
		2 2...10 Vdc	2 2...10 Vdc	R relay 1x	L Datalogger
		3 0...5 Vdc	3 0...5 Vdc	RR relay 2x	
		4 1...5 Vdc	4 1...5 Vdc	B buzzer	
		5 4...20 mA	5 4...20 mA		

sample order code: SHW.311 .MD

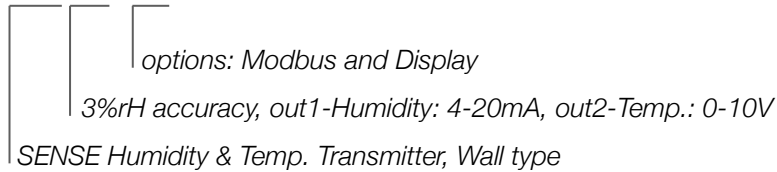

1. If you request 2nd analog output as Humidity out, please inform while ordering
2. DUCT and ROOM types are available, please check own datasheets
3. Relay and Buzzer options should have be ordered with Display option
4. For advanced options and special applications, please contact with us [info@senseandcontrol.com](mailto:info@senseandcontrol.com)









## General Notes

---

1. High density of some other gasses may effect the measurements.
2. Observe maximum permissible cable lengths.
3. If cable runs parallel to the mains cable: Use shielded cables.
4. Test only with certified calibration gasses.
5. The cable entry always should have to be pointing downwards.
6. The data indicated under 'Technical Data' apply only to vertically mounted transmitters.
7. Wall/Room type transmitters should have to be mounted in the center of wall but not near to any doors and windows.

## DIP Switch Settings

1. Please check if there is any special instruction on the enclosure or inside the cover

DIP	Temp. Ranges	DIP	Response
	0...50°C		1 sec.
	0...100°C		5 sec.
	-30...+70°C		10 sec.
	-40...+60°C		30 sec.

## Electrical Connections

1. Please be sure about current direction for current outputs and polarity for voltage outputs.
2. Relay contact is Normally Open and rating is max. 1A at 230VAC
3. We kindly advise using 24V for avoiding high voltage harmonics and external power relay for bigger loads
4. Please use shielded and twisted paired cables for Modbus connections
5. Please observe RS485 termination rules, max. 32 devices in a single Modbus line is advised

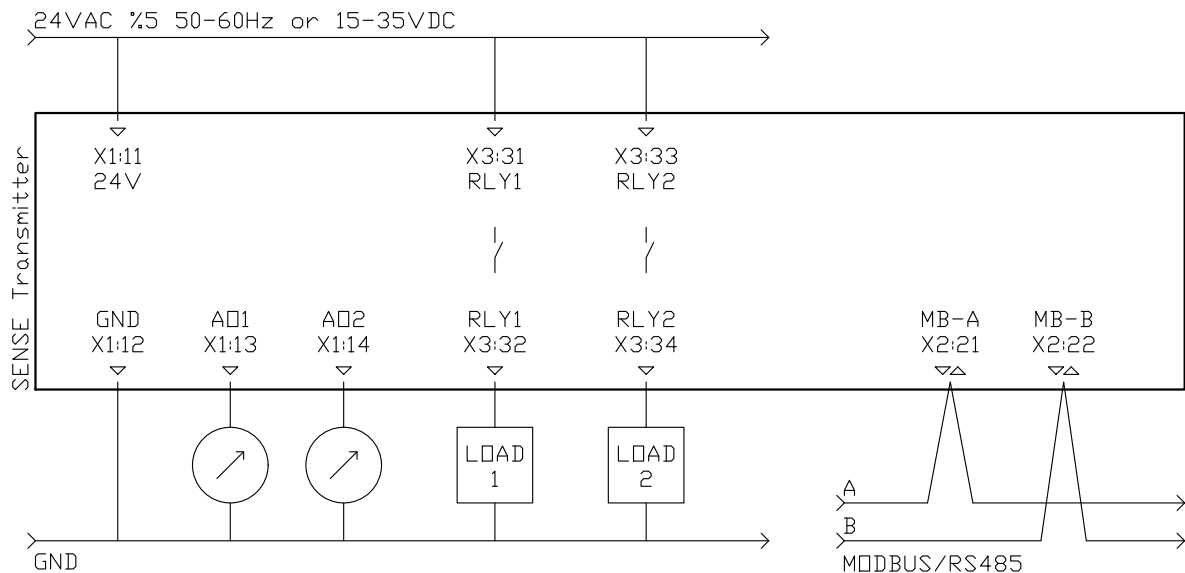

## Technical Data

---

Electrical	Power Supply	AC 24V ( $\pm$ %5), 50-60 Hz DC 15...35 V
	Power Consumption	< 2.5 W
Outputs	Current Output	4...20 mA, maximum 500 $\Omega$
	Voltage Output	0...10 Vdc, minimum 1.000 $\Omega$ 0...5 Vdc, minimum 1.000 $\Omega$
	Relay Output	max. rating 1A @ 220 Vac
Accuracy	Humidity	3%rH standard, 2%rH optional
	Temperature	0.5°C
Sensor	type	digital micro chip
	media	air or non aggressive gasses
	storage temperature	0...30°C
	operating temperature	-30...+80°C
Ranges	Humidity	0...100 %rH
	Temperature	0...50°C, 0...100°C, -30...+70°C, -40...+60°C
	Humidity	0...100 %rH
Connections	X1-X2 Terminals	Pluggable screw terminal
	X3 Terminals	Fixed screw terminal
	Cable	maximum 1.5mm <sup>2</sup>
Protection	SHW series	IP41 or NEMA 3
Standards	EMC Directive	EN 61326-1
Dimensions	enclosure	98.0 x 81.5 x 45.5 mm
	probe	Ø 12mm x 46mm
Weight Packed	SHW series	229 gr

# Transmitter Hardware

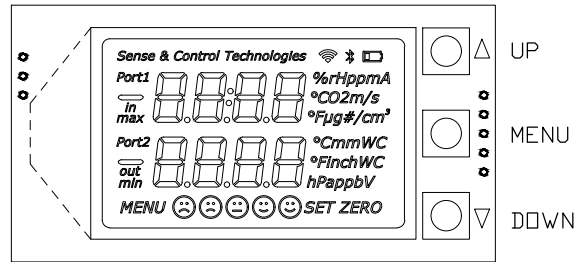
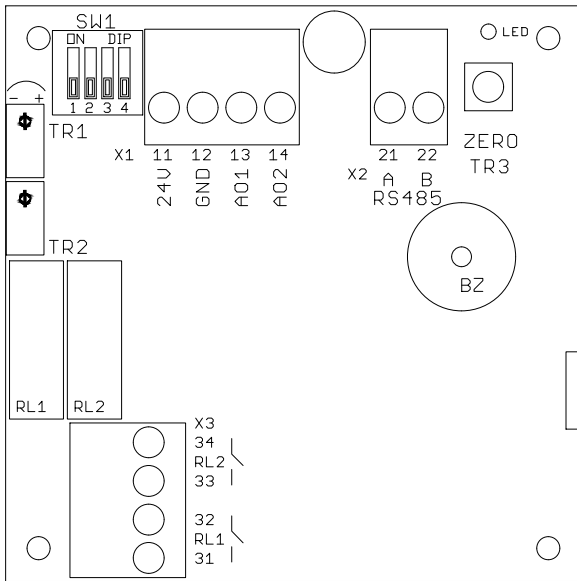

**SW1** DIP Switch for configuration range and response time

## X1 TERMINAL

<b>11</b>	24V	15...35 Vdc or 24 Vac (± %5, 50-60 Hz)
<b>12</b>	GND	ground for power and reference for outputs
<b>13</b>	AO1	analog output 1
<b>14</b>	AO2	analog output 2

## X2 TERMINAL

<b>21</b>	A / RS485	modbus communication positive pair
<b>22</b>	B / RS485	modbus communication negative pair

**LED** bead LED, periodically lights ON and OFF  
modbus communication, blinks when there is a communication

**TR1** not used

**TR2** not used

**ZERO / TR3** not used

**RL1 & RL2** relay 1 and relay 2

**BZ** buzzer

## X3 TERMINAL

<b>31</b>	NO - RL1	relay 1 dry contact max. rating 1A @ 220 Vac
<b>32</b>	NO - RL1	relay 1 dry contact max. rating 1A @ 220 Vac
<b>33</b>	NO - RL2	relay 2 dry contact max. rating 1A @ 220 Vac
<b>34</b>	NO - RL2	relay 2 dry contact max. rating 1A @ 220 Vac

# Display & Buttons

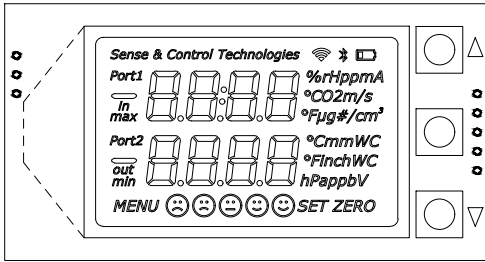

- UP** press for increasing the value or choosing the next parameter
- MENU** press and wait to enter MENU, click to navigate between sub menus one by one
- DOWN** press for decreasing the value or choosing the previous parameter

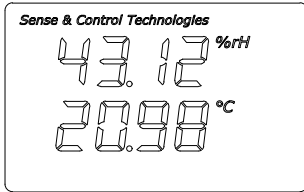

main screen  
transmitter is working



keep pressing MENU button until seeing SET  
transmitter is not working in MENU mode

## Parameters for Relay & Buzzer

Main Screen >>>>> r1 L > r1 H > r1 A > r2 L > r2 H > r2 A > BL > BH > BA > Main Screen

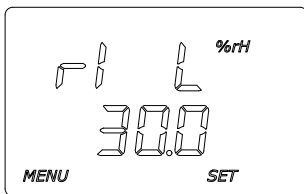

LOW set point for Relay 1

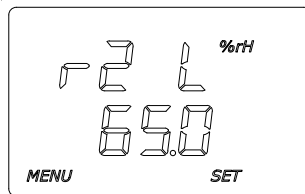

LOW set point for Relay 2

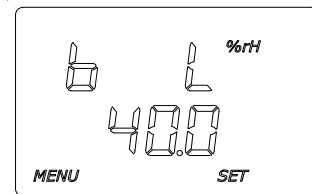

LOW set point for Buzzer

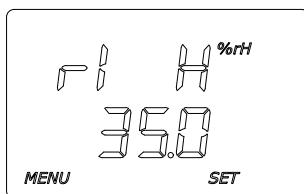

HIGH set point for Relay 1

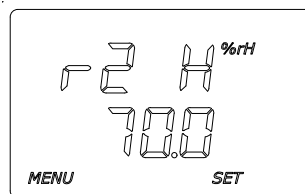

HIGH set point for Relay 2

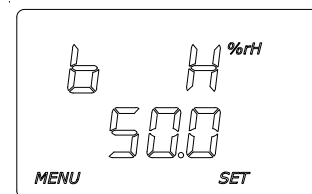

HIGH set point for Buzzer

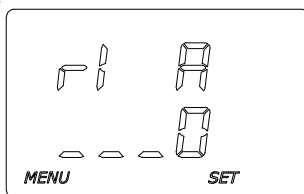

ACTION selection for Relay 1

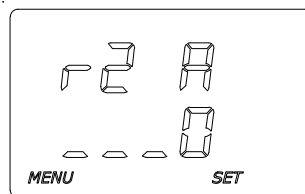

ACTION selection for Relay 2

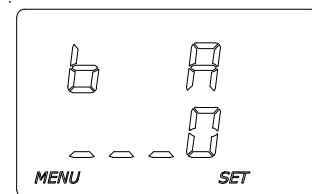

ACTION selection for Buzzer

## Actions for Relay & Buzzer



action 0, valid for relays and buzzer,  
 relay contact is always OPEN  
 buzzer is always SILENCE

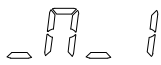

action 1, valid for relays and buzzer,  
 relay contact is CLOSED between points, OPEN under LOWpoint and OPEN over HIGHpoint  
 buzzer is WARNING between points, SILENCE under LOWpoint and SILENCE over HIGHpoint

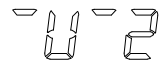

action 2, valid for relays and buzzer,  
 relay contact is OPEN between points, CLOSED under LOWpoint and OPEN over HIGHpoint  
 buzzer is SILENCE between points, WARNING under LOWpoint and SILENCE over HIGHpoint

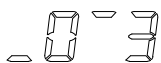

action 3, valid for relays and buzzer,  
 relay contact is CLOSED over HIGHpoint, OPEN under LOWpoint, hysteresis between points  
 buzzer is WARNING over HIGHpoint, SILENCE under LOWpoint, hysteresis between points

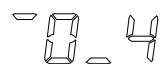

action 4, valid for relays and buzzer,  
 relay contact is OPEN over HIGHpoint, CLOSED under LOWpoint, hysteresis between points  
 buzzer is SILENCE over HIGHpoint, WARNING under LOWpoint, hysteresis between points



action 5, valid only for buzzer,  
 buzzer is WARNING over HIGHpoint, SILENCE under LOWpoint,  
 buzzer is WARNING intermittently between points,



action 6, valid only for buzzer,  
 buzzer is WARNING under LOWpoint, SILENCE over HIGHpoint,  
 buzzer is WARNING intermittently between points,



action 7, valid only for buzzer,  
 buzzer is following relay 1 contact,  
 buzzer is WARNING when relay 1 contact is CLOSED, SILENCE when the contact is OPEN



action 8, valid only for buzzer,  
 buzzer is following relay 2 contact,  
 buzzer is WARNING when relay 2 contact is CLOSED, SILENCE when the contact is OPEN

ACTIONS	under LOW	between LOW & HIGH	over HIGH
0 : 0.0.0	Open / Silence	Open / Silence	Open / Silence
1 : 0.1.0	Open / Silence	Closed / Warning	Open / Silence
2 : 1.0.1	Closed / Warning	Open / Silence	Closed / Warning
3 : 0.X.1	Open / Silence	Hysteresis	Closed / Warning
4 : 1.X.0	Closed / Warning	Hysteresis	Open / Silence
5 : 0.-.1	Silence	Pre Alarm	Warning
6 : 1.-.0	Warning	Pre Alarm	Silence
7 : =r1	Silence when RL1 is Open, Warning when RL1 is Closed		
8 : = r2	Silence when RL2 is Open, Warning when RL2 is Closed		

0 : Relay Contact is OPEN, Buzzer is in Silent mode

1 : Relay Contact is CLOSED, Buzzer is in Warning mode

X : Relay Contact is at HYSTERESIS position, OPEN if previous position open, CLOSED if previous position closed

: Buzzer is in HYSTERESIS mode, Silent if previous mode is silent, Warning if previous mode is warning

- : Buzzer is in PRE ALARM mode, Buzzer is warning intermittently

## Modbus RS485 Protocol

Default Settings: Modbus ID:1, 9600, 8bit, None, 1. Register Table starts from Base 1.

Use Function 3 for Reading and Function 6 for Writing Holding Registers. Whenever writing to any Modbus Parameter, new parameter is activated instantly and you should have to configure master device according to new parameters. For every reboot/initializing, Modbus is activated with default parameters for 3 seconds. After 3 seconds, Modbus is reconfigured according your parameter settings.

Unlisted registers are for analog output calibrations and some system parameters. Please do not change unlisted registers.

Register	R/W	Range	Description
1	R & W	1...254	Modbus Address
2	R & W	0...4	Baudrate, 0: 9.600, 1: 19.200, 2: 38.400, 3: 57.600, 4: 115.200
3	R & W	0...3	Bit_Parity_Stop, 0: 8bit_None_1, 1: 8bit_None_2, 2: 8bit_Even_1, 3: 8bit_Odd_1
4	R		Humidity as %rH x10, divide by 10 for exact value
5	R		Temperature as C x10, divide by 10 for exact value
6	R	0 or 1	Relay 1, contact position, 0: OFF - Contact is Open, 1: ON - Contact is Closed
7	R	0...1.000	Relay 1, LOW point
8	R	0...1.000	Relay 1, HIGH point
9	R	0...4	Relay 1, ACTION
10	R	0 or 1	Relay 2, contact position, 0: OFF - Contact is Open, 1: ON - Contact is Closed
11	R	0...1.000	Relay 2, LOW point
12	R	0...1.000	Relay 2, HIGH point
13	R	0...4	Relay 2, ACTION
14	R	0 or 1	Buzzer, 0: OK-Silence, 1: PreAlarm - warning intermittently, 2: WARNING continuously
15	R	0...1.000	Buzzer, LOW point
16	R	0...1.000	Buzzer, HIGH point
17	R	0...4	Buzzer, ACTION
18-29	R		Only for service needs
30	R		Blank
31	R		Temperature as C x10, divide by 10 for exact value
32	R		Temperature as C
33	R		Temperature as F x10, divide by 10 for exact value
34	R		Temperature as F
35	R		Humidity as %rH x10, divide by 10 for exact value
36	R		Humidity as %rH



Drawings

