

GREYSTONE ENERGY SYSTEMS INC

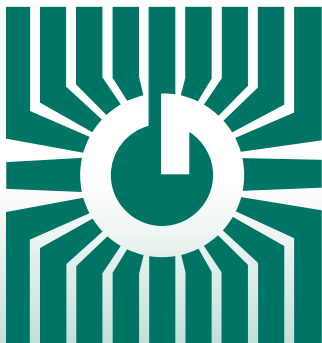

ROOM TEMPERATURE SENSORS TE200 Series



Precision temperature control/sensing

FEATURES:

- Precision Thermistor or RTD sensing elements
- Various enclosure styles
- Various options: Setpoint Adjustment, Override, etc.
- Custom laser etching available

*Peace of mind
through reliable
temperature monitoring*

GREYSTONE HAS AN ISO 9001 REGISTERED QUALITY SYSTEM

DESCRIPTION:

The TE200 series of room temperature sensors incorporate a precision platinum RTD or NTC thermistor in an attractive wall mount enclosure for the most efficient environmental monitoring and control systems.

The TE200 series is available in three different enclosures and has various options available such as setpoint adjustment, manual override, etc. that allows for use in a multitude of applications.

SPECIFICATIONS:

Sensor.....	Several available - See Ordering Information
Sensor Accuracy.....	Thermistors: $\pm 0.2^{\circ}\text{C}$ ($\pm 0.36^{\circ}\text{F}$) - 0 to 70°C (32 to 158°F) Platinum RTD's: $\pm 0.3^{\circ}\text{C}$ ($\pm 0.54^{\circ}\text{F}$) @ 0°C (32°F) Nickel RTD's: $\pm 0.4^{\circ}\text{C}$ ($\pm 0.72^{\circ}\text{F}$) @ 0°C (32°F)
Operating Temperature	A & AD: 0 - 50°C (32 - 122°F) AS: -20 - 50°C (-4 - 122°F)
Enclosures	A - White ABS - IP20 (NEMA 1) AD - White ABS - IP20 (NEMA 1) AS - Stainless Steel - IP50 (NEMA 1)
Wiring Connections.....	Sensor only - Pigtail, 2 or 3 wire With Options - Screw terminal block (14 to 22 AWG)

OPTIONS:

Setpoint Adjustment

Standard	20K to 30K Ω linear slidepot
Custom spans available	1K, 2K, 5K, 10K or 20K Ω

Manual Override

Concealed	Momentary pushbutton, N.O., SPST, 50 mA @12 Vdc AD only
Exposed	Momentary pushbutton, N.O., SPST, 50 mA @12 Vdc
Grayhill Exposed	Momentary pushbutton, N.O., SPST, 3A @ 115 Vac AS only

Status Indicator

LED.....	Yellow (LY), Red (LR) or Green (LG), Various voltage models available.
----------	--

Communication Jacks

Phono	3.5 mm phono jack, 3 wire connection (Ring, Tip, Mid)
4 pin	4 Pin header. Requires HHTA - Hand Held Adapter

Miscellaneous

Tamperproof Screws	18-8 SS, Tamper-Resist, Flat Head, Machine Screw, Drilled Spanner, 6-32 Thread, 1" Length AS Only
--------------------------	---



AD) Designer – Features include a two-piece enclosure that mounts directly to a wall box or on any wall. Available with various options, including setpoint adjustments, & push button overrides.



AS) Surface - A stainless steel plate which can be mounted to a wall box used where tamper-proof or protection is required. Available with various options, including push button overrides and or LED's.



A) Micro – Includes a compact snap-mounted cover for ease of installation, available with various temperature sensors.

TE200 - ROOM TEMPERATURE SENSOR:

PRODUCT ORDERING INFORMATION:

MODEL	Product Description
TE200	Temperature Sensor Series

CODE	Enclosure
A	Micro
AD	Designer
AS	S/S plate

CODE	Sensor
2	100 Ω Platinum, IEC 751, 385 Alpha, thin film
5	1801 Ω, NTC Thermistor, ±0.2 C
6	3000 Ω, NTC Thermistor, ±0.2 C
7	10,000 Ω, type 3, NTC Thermistor, ±0.2 C
8	2.252K Ω, NTC Thermistor, ±0.2 C
12	1000 Ω Platinum, IEC 751, 385 Alpha, thin film
13	1000 Ω Nickel, Class B, DIN 43760
14	10,000 Ω, type 3, NTC Thermistor, ±0.2 C c/w 11K shunt resistor
20	20,000 Ω, NTC Thermistor, ±0.2 C
24	10,000 Ω, type 2, NTC Thermistor, ±0.2 C

CODE	TE200AD/AS Options (Multiple selections can be made)	Enclosure Availability
AP	20-30K linear slide pot for set point control (call for other values)	AD
AS	Concealed push button momentary switch (N.O.)	AD
BS	Exposed push button momentary switch (NO)	AD
GB	Grayhill exposed pushbutton, (N.O.), SPST, 3A	AS
LY	Yellow LED	AD, AS
LR	Red LED	AD, AS
LG	Green LED	AD, AS
CJ	3.5mm Phono jack for remote system access	AD, AS
AE	External jack for remote system access (4-pin header)	AS
TP	Tamper proof security screws	AS

TE200	AD	7	AP	BS
-------	----	---	----	----

Greystone Energy Systems, Inc. reserves the right to make design modifications without prior notice.

NOTE:
Due to the many possible configurations, special part numbers may be required, please contact Greystone for more information.

ACCESSORIES:

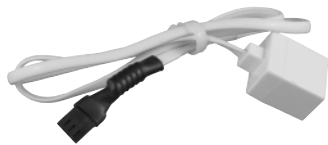

HHTA-XXX

The HHTA - Handheld Adapter converts the Greystone standard 4 pin connector to the connector of choice such as a RJ12, phone jack. Several styles and configurations are available. Please contact Greystone.



94062A114

A No 6, Spanner screwdriver for use with the tamperproof screw option (TP) on TE200AS series surface sensors.

DIMENSIONS:

AD) Designer

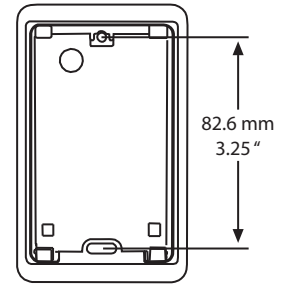
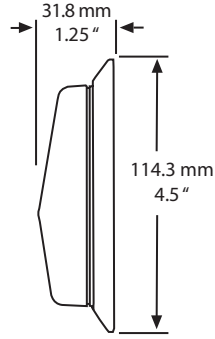
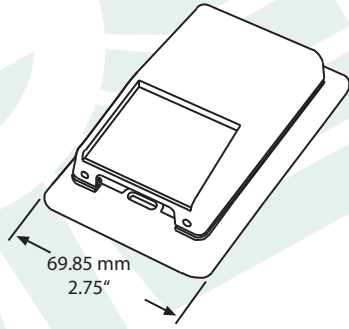

AS) Surface

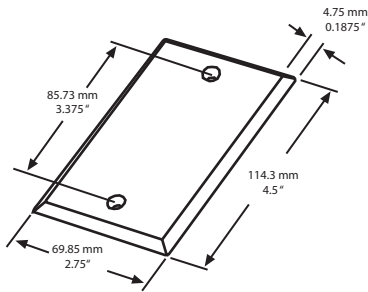

A) Micro

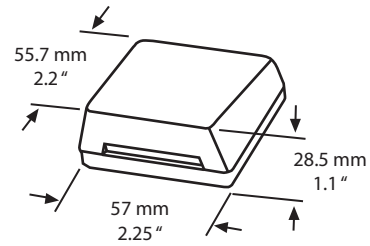

GREYSTONE
ENERGY SYSTEMS INC
Greystone Energy Systems, Inc.

RoHS
COMPLIANT



Greystone Energy Systems Inc. is one of North America's largest ISO registered manufacturers of HVAC/R sensors and transmitters for Building Automation Management Systems.

We have conscientiously established a worldwide reputation as an industry leader by maintaining leading-edge design technology, prompt technical support, and a commitment to on-time deliveries. We take pride in our Quality Management System which is ISO 9001 certified, assuring our customers of consistent product reliability.

GREYSTONE HAS AN **ISO 9001** REGISTERED QUALITY SYSTEM