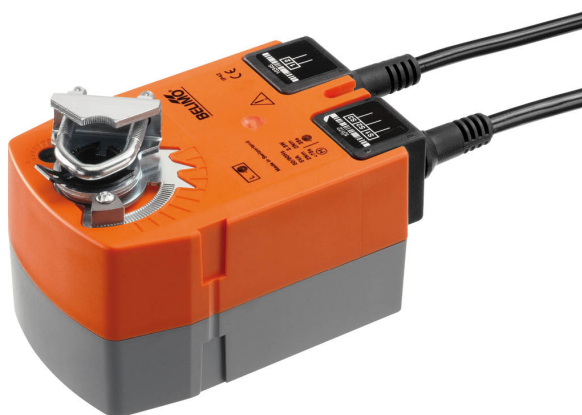

- Air damper size up to approx. 0.5 m²
- Torque motor 2.5 Nm
- Nominal voltage AC 100...240 V
- Control Open/close
- with integrated auxiliary switch

Technical data

Electrical data	Nominal voltage	AC 100...240 V
	Nominal voltage frequency	50/60 Hz
	Nominal voltage range	AC 85...264 V
	Power consumption in operation	2.5 W
	Power consumption in rest position	1.5 W
	Power consumption for wire sizing	5 VA
	Auxiliary switch	1 x SPDT, 0...100%
	Switching capacity auxiliary switch	1 mA...3 A (0.5 A inductive), AC 250 V
	Connection supply / control	Cable 1 m, 2 x 0.75 mm ²
	Connection auxiliary switch	Cable 1 m, 3 x 0.75 mm ²
	Parallel operation	Yes (note the performance data)
Functional data	Torque motor	2.5 Nm
	Torque fail-safe	2.5 Nm
	Direction of motion motor	selectable by mounting L/R
	Direction of motion fail-safe	selectable by mounting L/R
	Manual override	No
	Angle of rotation	Max. 95°
	Angle of rotation note	adjustable starting at 37% in 2.5% steps (with mechanical end stop)
	Running time motor	75 s / 90°
	Running time fail-safe	<25 s / 90°
	Sound power level, motor	50 dB(A)
	Mechanical interface	Universal shaft clamp 6...12.7 mm
	Position indication	Mechanical
	Service life	Min. 60'000 fail-safe positions
Safety data	Protection class IEC/EN	II reinforced insulation
	Protection class auxiliary switch IEC/EN	II reinforced insulation
	Degree of protection IEC/EN	IP42
	EMC	CE according to 2014/30/EU
	Low voltage directive	CE according to 2014/35/EU
	Certification IEC/EN	IEC/EN 60730-1 and IEC/EN 60730-2-14
	Mode of operation	Type 1.AA.B
	Overvoltage category	III
	Rated impulse voltage supply / control	4 kV
	Rated impulse voltage auxiliary switch	4 kV
	Control pollution degree	3
	Ambient temperature	-30...50°C
	Storage temperature	-40...80°C
	Ambient humidity	Max. 95% r.H., non-condensing

Weight	Weight	0.66 kg
	Weight	0.66 kg

Safety notes

- The device must not be used outside the specified field of application, especially not in aircraft or in any other airborne means of transport.
- Outdoor application: only possible in case that no (sea) water, snow, ice, insulation or aggressive gases interfere directly with the device and that it is ensured that the ambient conditions remain within the thresholds according to the data sheet at any time.
- Caution: Power supply voltage!
- Only authorised specialists may carry out installation. All applicable legal or institutional installation regulations must be complied during installation.
- The device may only be opened at the manufacturer's site. It does not contain any parts that can be replaced or repaired by the user.
- Cables must not be removed from the device.
- The device contains electrical and electronic components and must not be disposed of as household refuse. All locally valid regulations and requirements must be observed.

Product features

Mode of operation	The actuator moves the damper to the operating position at the same time as tensioning the return spring. The damper is turned back to the safety position by spring energy when the supply voltage is interrupted.
Simple direct mounting	Simple direct mounting on the damper shaft with a universal shaft clamp, supplied with an anti-rotation device to prevent the actuator from rotating.
Adjustable angle of rotation	Adjustable angle of rotation with mechanical end stops.
High functional reliability	The actuator is overload protected, requires no limit switches and automatically stops when the end stop is reached.
Flexible signalling	With adjustable auxiliary switch (0...100%)

Accessories

Mechanical accessories	Description	Type
	Actuator arm	AH-TF
	Shaft extension 170 mm Ø10 mm for damper shaft Ø 6...16 mm	AV6-20
	Ball joint suitable for damper crank arm KH8 / KH10	KG10A
	Ball joint suitable for damper crank arm KH8	KG8
	Damper crank arm Slot width 8.2 mm, clamping range Ø10...18 mm	KH8
	Screw fastening kit	SB-TF
	Anti-rotation mechanism 180 mm, Multipack 20 pcs.	Z-ARS180
	Angle of rotation limiter, with end stop	ZDB-TF
	Form fit adapter 8x8 mm	ZF8-TF
	Mounting kit for linkage operation for flat and side installation	ZG-TF1

Electrical installation

Caution: Power supply voltage!
Parallel connection of other actuators possible. Observe the performance data.

Wiring diagrams

AC 230 V, open/close

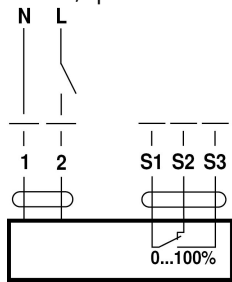

Cable colours:



- 1 = blue
- 2 = brown
- S1 = violet
- S2 = red
- S3 = white

Dimensions

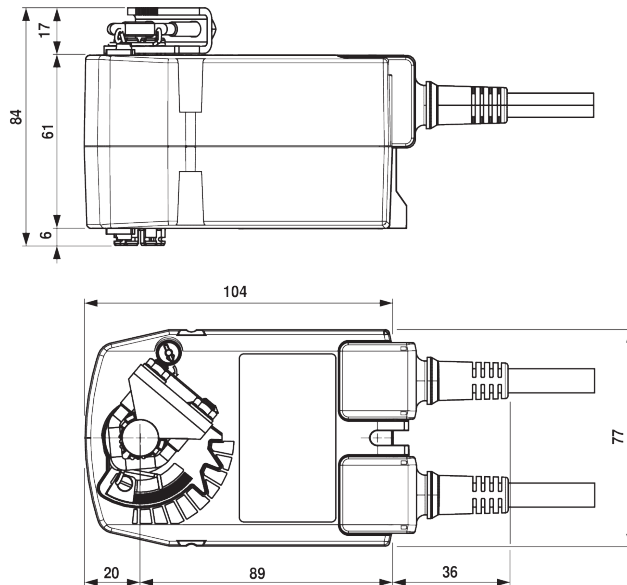
Dimensional drawings



Clamping range

	
6...12.7	6...12.7

Shaft length

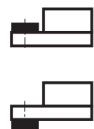
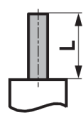

Min. 84

Min. 20