



ACVATIX™

MiniCombiValves (MCV)

VPD..
VPE..

Radiator valves featuring integrated differential pressure control for 2-pipe heating systems, fan coils and chilled ceiling systems

- **Automatic flow limitation under all operating conditions**
- **Straightforward design of plant with no need for safety margins**
- **Thanks to MCV no hydraulic balancing within the zone required**
- **No additional line balancing valves required**
- **No noise problems**
- **Integrated presetting of k_v -values**
- **DIN DN 10 and DN 15**
- **Valve bodies made of brass, mat nickel-plated**
- **Internally and externally threaded (Rp/R) conforming to ISO 7-1**
- **Can be combined with RTN.. thermostatic, STA..3.. electrothermal and SSA.. electromotoric actuators**

Use

The MiniCombiValves are designed for use in 2-pipe heating systems, fan coil and chilled ceiling systems to provide individual room control and limitation. The MiniCombiValves with integrated differential pressure control ensure that the amount of heat emitted by the radiator is well defined, irrespective of operating conditions. For this reason, line balancing valves normally used for hydraulic balancing are no longer required.

Due to their integrated differential pressure control, these valves are extremely well suited for new houses and buildings, or for upgrading plants where hydraulic problems have occurred. They are basically recommended in all rooms, especially where heat gains or different temperature levels occur.

Type summary

Type (DIN range)		DN	Δp_{\min} [bar]	\dot{V} [l/h]
2-port valve	Angle valves			
VPD110A-45 ¹⁾	VPE110A-45 ¹⁾	10	0,06	45
VPD110A-90 ¹⁾	VPE110A-90 ¹⁾	10	0,08	90
VPD110A-145 ¹⁾	VPE110A-145 ¹⁾	10	0,10	145
VPD110B-200 ¹⁾	VPE110B-200 ¹⁾	10	0,20	200
VPD115A-45 ¹⁾	VPE115A-45 ¹⁾	15	0,06	45
VPD115A-90 ¹⁾	VPE115A-90 ¹⁾	15	0,08	90
VPD115A-145 ¹⁾	VPE115A-145 ¹⁾	15	0,10	145
VPD115B-200 ¹⁾	VPE115B-200 ¹⁾	15	0,20	200

¹⁾ = While stocks last

Δp_w = effective pressure (controlled differential pressure) in bar

Δp_{\min} = minimum differential pressure required across the valve in bar

\dot{V} = volumetric flow at a stroke of 0.5 mm, total range 25...483 l/h, refer to page 4

Ordering

Example:

Product number	Stock number	Designation	Quantity
VPD115A-90	VPD115A-90	2-port valve	2

Delivery

Valves, actuators and accessories are supplied in separate packages.

Valve insert

AV100-VP1

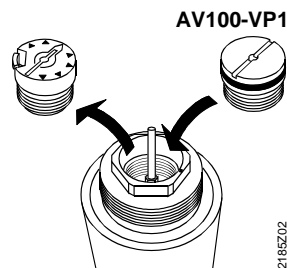

The valve sealing gland cannot be replaced under pressure. In case of leakage, the stroke limiter can be replaced by the AV100-VP1 valve insert while the plant is under pressure. The valve insert can be retrofitted to any type of MiniCombiValve. To do this, replace the stroke limiter by the AV100-VP1 valve insert.

The valve insert is supplied complete with Mounting Instructions 74 319 0356 0.

Rev.-Nr.

See p. 9.

Accessories



ATN3
Manual knob (RAL9016)



ATN4
White manual knob

Equipment combinations

Product	Product numbers	Data Sheet
Electrothermal actuators	STA..3..	N4884
Electric actuators	SSA31.. / SSA61.. / SSA81..	N4893
Thermostatic actuators	RTN..	N2111

Technical note

NO, NC valves	NO valves	<ul style="list-style-type: none"> Valve is open without actuator (normally open) and the valve stem is extended. Examples: Radiator valves VDN.., VEN.., VUN.. or MiniCombiValves VPD.. and VPE..
	NC valves	<ul style="list-style-type: none"> Valve is closed without actuator (normally closed) and the valve stem is extended. Example: Small valves V..P47..
Valve and actuator combinations	NC function	<ul style="list-style-type: none"> STA .. actuator stem is extended, when de-energized. NO valve is closed (e.g. VPD.., VPE.., radiator valve).
	NO function	<ul style="list-style-type: none"> Valve is open, when de-energized. STP.. actuator is required.

Application note

		STA..	STP..
		Actuator de-energized	
Radiator valves	• VPD.., VPE..	closed	open ¹⁾

¹⁾ Not applicable with DESIGO RX..

Technical design / mechanical design

Functions

- Control valve for influencing the volumetric flow and pressure controller for automatic balancing
- Compensation of differential pressure variations with complete hydraulic decoupling of consumers
- Manual adjustment for shutoff and temporary operation of heating plant during the construction phase. A constant flow rate is also ensured in manual operation, independent of the differential pressure

Construction

Straight valve VPD..

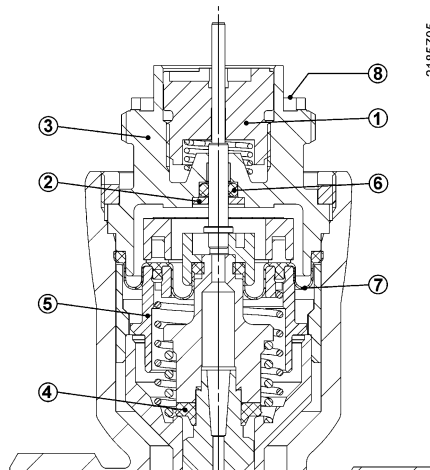

- Stroke limiter for preadjustment and shutoff
- Sealing gland with blocking protection
- Connecting piece for actuator
- Valve plug (made of plastic, soft shutoff)
- Δp controller (made of plastic, hard shutoff)
- Stem sealing
- Diaphragm
- Stamp indicating effective pressure and volumetric flow (e.g. B-200)

The MiniCombiValves allow preadjustment of the required volumetric flow \dot{V} . This preadjustment is made by limiting the valve's stroke.

With the MiniCombiValve, the adjusted value represents the maximum flow rate because the integrated pressure controller maintains the volumetric flow at a constant level, even if the differential pressure varies between 0.1 and 2 bar. For this reason, central precontrol of the pressure is not required, and the valve's authority need no longer be considered.

The water must be free from organic substances.

Engineering example

The valve is to be sized based on the volumetric flow \dot{V} resulting from the required radiator output.

Basis of design

1. Ascertain heat demand Q in W
2. Determine temperature differential ΔT in K
3. Volumetric flow $\dot{V} = \frac{Q}{c \times \Delta t} \left[\frac{W}{(J/kg \times K) \times K} \times 3600 = \frac{l}{h} \right]$

\dot{V} = volumetric flow l/h c = specific heat capacity J/kg x K
 Q = heat demand W ΔT = temperature differential K

Example

1. Heat demand $\dot{Q} = 2800$ W
2. Temperature differential $\Delta T = 20$ K
3. Volumetric flow $\dot{V} = \frac{2800}{4187 \times 20} \times 3600 = 120.37 \left[\frac{l}{h} \right]$



Result

With this calculated value and a $\Delta p_{V100} = 100$ kPa, the required type of valve can be determined from the following preadjustment table or from the sizing chart (page 5).

- In this example, the ideal valve would be VPD / VPE..B-120 with a factory setting of 3
- Valve type VPD / VPE..A-90 is possible also, but the preadjustment must be appropriately changed
- Valve type VPD/VPE..A-145 is theoretically also possible, but the stroke is very short then.

Recommendation therefore: The valves should operate at a preadjustment of 3 or higher.

Preadjustment table

Suited for use with thermostatic radiator valve heads  1)	✓	✓	✓	✓	✓	✓	✓													
Suited for use - with electrothermal or electromotoric actuators  2)	Possible application range								Recommended application range											
	✓	✓	✓	✓	✓	✓	✓	✓	✓	✓	✓	✓	✓	✓	✓	✓	✓	✓	✓	✓
- SSA61.. 														✓ ³⁾	✓	✓	✓	✓	✓	
Stroke [mm]	0.3	0.4	0.5	0.6	0.7	0.8	0.9	1	1.1	1.2	1.3	1.4	1.5	1.6	1.7	1.8	1.9	2		
Reference number ⁴⁾	1	2	3	4	5	6	7	X	Y	Z										
Reference number + 360° ⁵⁾											1	2	3	4	5	6	7	X		
Product number	Volumetric flow [l/h] in relation to reference number of preadjustment																			
VPD / VPE..A-45	25	36	45	53	60	67	72	77	81	85	88	91	93	96	98	100	102	104		
VPD / VPE..A-90	57	75	90	103	114	123	132	139	145	151	156	160	165	169	173	177	181	185		
VPD / VPE..A-145	86	117	145	169	189	207	223	236	248	258	267	276	284	291	298	305	311	318		
VPD / VPE..B-200	95	151	200	243	280	311	339	362	383	400	415	428	439	450	459	467	475	483		

→ Factory setting: \dot{V}_{nominal} = value at 0.5 mm stroke or reference number 3

- 1) Recommended from 25 to 339 l/h
- 2) Recommended from 77 to 483 l/h
- 3) Caution: When the Siemens VPD.. and VPE.. radiator valves are combined with SSA61.. actuators, the flow rate preadjustment must be set to min. 1.5 mm valve stroke. If the valve travel is less than 1.5 mm, self-calibration is not possible and the valve with the actuator remains blocked.

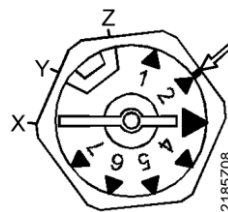
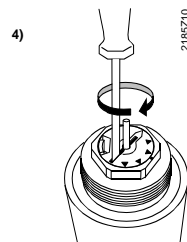

Example:
Setting 2

5)

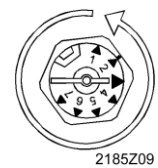

+ 360°
corresponds
to a full
revolution

Sizing chart

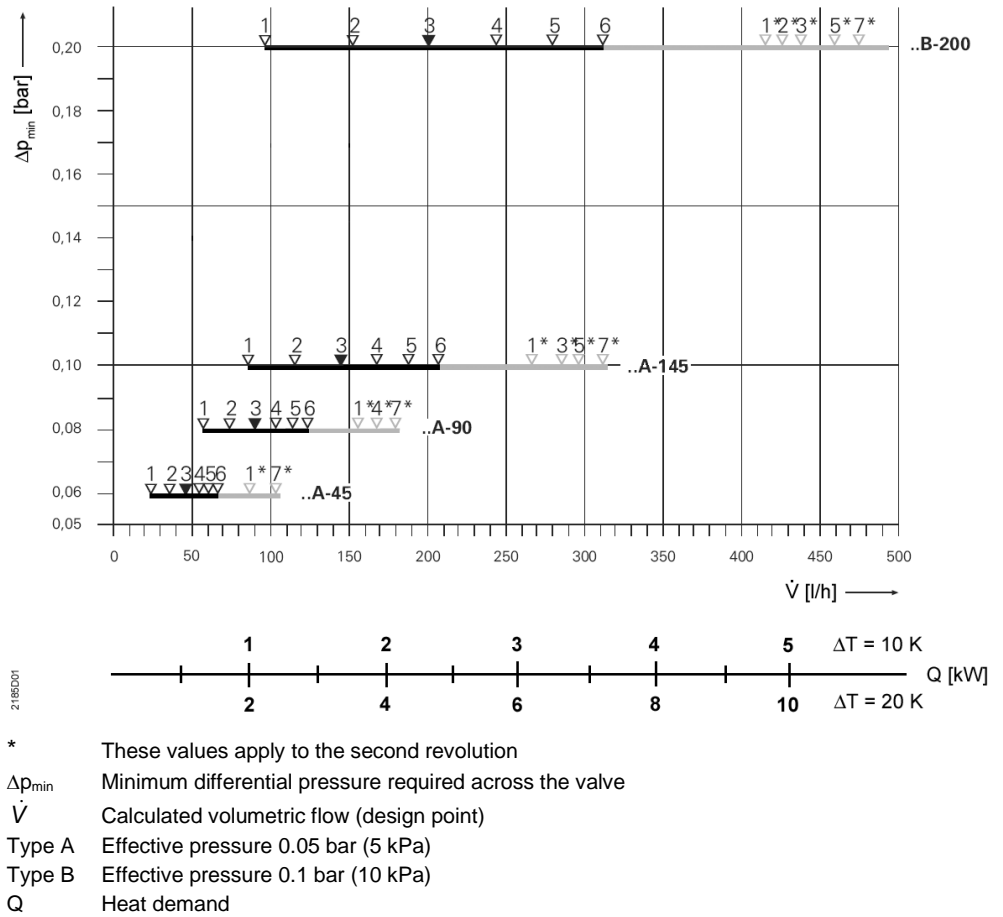

Commissioning notes

The MiniCombiValves (MCV) have to be open when flushing or pressure testing the system. Strong pressure impacts can damage closed MCVs.

Montage

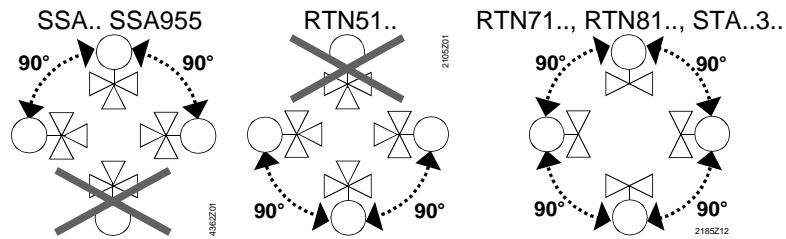

Maintenance

The MiniCombiValves require no maintenance.

Repair

If the stem sealing gland leaks, the stroke limiter can be replaced by valve insert AV100-VP1. Otherwise the valves cannot be repaired, they have to be replaced as complete units.

Disposal

Do not dispose of the device as household waste.

Disposal

- Special handling of individual components may be mandated by law or make ecological sense.
- Observe all local and currently applicable laws and regulations.

Warranty

The technical data given for these applications are valid only when used with actuators listed under "Equipment combination", page 2.

Any warranty becomes void by unauthorized manipulations or opening the MiniCombiValves.

When using the valves with actuators of other manufacture proper functioning must be ensured by the user. Any warranty by Siemens Switzerland Ltd / HVAC Products becomes void.

Technical data

Functional data	PN class	PN 10	
	Permissible media	cold or low-temperature hot water, water with ethylene-glycol < 30 % (water with propylene-glycol not allowed); recommendation: water treatment to VDI 2035	
	Medium temperature	1...90 °C	
	Permissible operating pressure	max. 1000 kPa (10 bar)	
	Differential pressure	max. 200 kPa (2 bar)	
	Controlled differential pressure (Δp_w): Type A	5 kPa (0.05 bar)	
	Type B	10 kPa (0.1 bar)	
	Spring force at the closing point	35 N	
	Stroke	2.5 mm	
	Closing dimension	11.5 mm	
	Materials	Valve body	brass CuZn40Pb2, mat, nickel-plated
		Protective cover	polypropylene
		Diaphragm and seals	EPDM
Dimensions / weight	refer to "Dimensions", page 9		
	Mounting length	EN 215	
	Thread	Rp internally threaded to ISO 7-1 R externally threaded to ISO 7-1 G-thread to ISO 228-1	
	Fixing on actuator	M30 x 1.5	
Standards, directives and approvals	Pressure Equipment Directive	PED 2014/68/EU	
	Pressure Accessories	Scope: Article 1, section 1 Definitions: Article 2, section 5	
	Fluid group 2	without CE-marking as per article 4, section 3 (sound engineering practice) ¹⁾	
	EAC Conformity	Eurasia Conformity	
	Environmental compatibility	The product environmental declaration CE1E2105en ²⁾ contains data on environmentally compatible product design and assessments (RoHS compliance, materials composition, packaging, environmental benefit, disposal).	

¹⁾ Valves where PS x DN < 1000, do not require special testing and cannot carry the CE label.

²⁾ The documents can be downloaded from <http://siemens.com/bt/download>.

Dimensions

VPD..

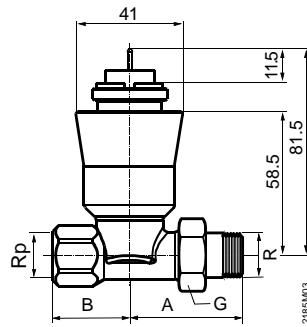

VPE..

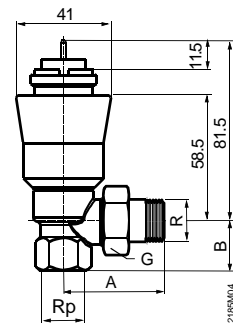

DIN version

Prod. no.	DN	Dimensions [mm]		Thread [inch]			Weight ¹⁾ [kg]
		A	B	Rp	R	G	
VPD1..	10	51.5	32	3/8	3/8	5/8	0.50
VPE1..	10	50.5	22	3/8	3/8	5/8	0.50
VPD1..	15	61.5	32	1/2	1/2	3/4	0.56
VPE1..	15	56.5	26	1/2	1/2	3/4	0.56

Rp = internally threaded to ISO 7-1

G = thread to ISO 228-1

R = externally threaded to ISO 7-1

¹⁾ Weight incl. packaging

Spare parts

Type	Stock No.	Description	Number
74 676 0296 0	74 676 0296 0	Manual knob for VPD.., VPE..	10

Revision numbers

Type reference DIN range	Valid from date (yy/mm)
VPD110A-45	10/04
VPD110A-90	10/04
VPD110A-145	10/04
VPD115A-45	10/04
VPD115A-90	10/04
VPD115A-145	10/04
VPD110B-200	10/04
VPD115B-200	10/04
VPE110A-45	10/04
VPE110A-90	10/04
VPE110A-145	10/04
VPE115A-45	10/04
VPE115A-90	10/04
VPE115A-145	10/04
VPE110B-200	10/04
VPE115B-200	10/04

Issued by:
Siemens Switzerland Ltd
Smart Infrastructure
Global Headquarters
Theilerstrasse 1a
CH-6300 Zug
+41 58 724-2424
www.siemens.com/buildingtechnologies

© Siemens Switzerland Ltd 2002
Delivery and technical specifications subject to change