

MODELS		DN [mm]	Kvs [m ³ /h]	STROKE [mm]
2-ways	3-ways			
VSB3F	VMB3F	20	6,3	16,5
VSB4F	VMB4F	25	10	
VSB5F	VMB5F	32	16	
VSB6F	VMB6F	40	22	
VSB8F	VMB8F	50	30	
VSB8AF	VMB8AF		40	

APPLICATION AND USE

Two-way VSB.F and three-way VMB.F valves can be used either for control or fluid detection in air-conditioning, thermoventilation and heating plants, both environmental and industrial, in machines for product thermal process.

Three-way valves should be used only as mixing valves; angle way should never be used for control purposes.

MANUFACTURING CHARACTERISTICS

The valve body is in G25 cast iron (only DN15 valves have brass body and fitting). The plug is in brass with Contoured-type profile on direct way and V-port on angle way.

The stem is in CrNi steel with threaded M8 end. There are PN16 flanged connections and slip-on flanges. The stem packing is constituted by EPDM O-ring with graphited teflon scraper rings.

NOTE: The valves are also available in the stainless steel plug version (profile and Kvs are the same of the brass plug). For further sales information, please contact our Sales Support.

TECHNICAL CHARACTERISTICS

Construction:	1600kPa max
control characteristics:	direct way: equal-percentage angle way: linear (VMB.F)
leakage*	direct way 0...0,03% of Kvs angle way 0...0,2% of Kvs (VMB.F)
connections:	PN16 flanged
stroke:	16,5mm (max 18,5)
Allowed fluids:	
- water:	max. temperature 150°C min. temperature -10°C (in case of ice on stem and gasket, use the stem-heater, see actuators data sheets) glycol added max 50%
- saturated steam:	max. temp. 150°C max. pressure 250kPa (absolute value)
weight:	see dimensions

* Leakage is measured according to the EN1349 standard.

NOTE: If V.BF valves are assembled with MVB+spacer (MVBHT) the max. operating temperature is 140°C, while without spacer is 120°C. For other actuators the max. operating temperature is 150°C.



OPERATION

When stem is up, the direct way is closed, with stem down direct way is open.

INSTALLATION

Before valves are mounted, make sure that pipes are clean, free from welding slags, that are perfectly lined up with the valve body and not subjected to vibrations.

The valve can be mounted in any position except upside-down (for MVH actuators see Fig. 3).

While assembling, respect the flow directions indicated by the letters located on the valve body (see Figures 1 and 2) and the application schemes.

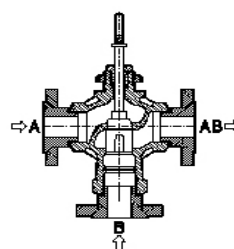

FIG. 1

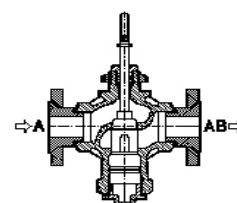
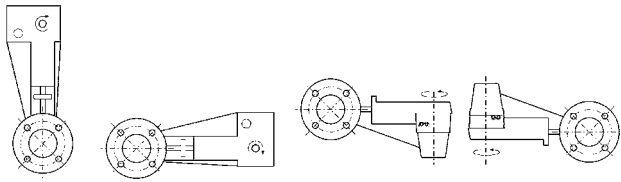

FIG. 2

MOUNTING POSITIONS



Yes

No

ACTUATORS

VSB.F and VMB.F are controlled by CONTROLLI MVB, MVH, MVH-56FA/C, MVE actuators.

APPLICATION SCHEMES

VSB.F VALVES

a) Variable flow control when used

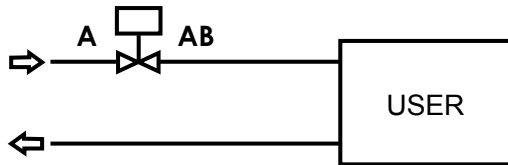

b) Constant flow when used in injection circuits

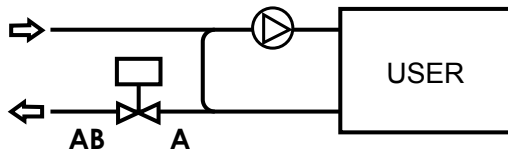

VMB.F VALVES

c) Variable flow mixing when used

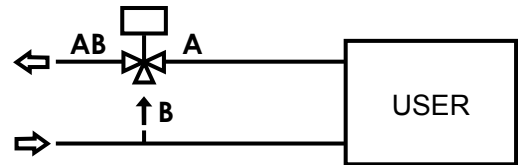

d) Constant flow mixing when used in injection or tapping circuits

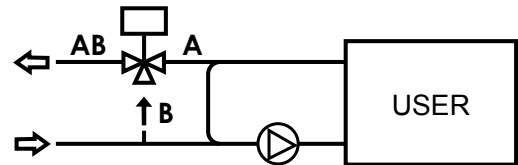

MAX DIFFERENTIAL CLOSE-OFF PRESSURE [kPa]

Model	DN	MVH		MVHA/C*		MVB		MVE.06		MVE.10		MVE.15		MVE.22	
		A-AB	B-AB	A-AB	B-AB	A-AB	B-AB	A-AB	B-AB	A-AB	B-AB	A-AB	B-AB	A-AB	B-AB
VSB.F VMB.F	3/4"	1600	1600	1600	1560	1080	260	1600	1310	1600	1600	1600	1600	1600	1600
	1"	1600	1600	1380	1030	680	170	1190	870	1600	1560	1600	1600	1600	1600
	1 1/4"	1600	1370	840	650	410	110	720	540	1210	980	1600	1540	1600	1600
	1 1/2"	1170	990	590	470	290	80	500	390	860	710	1300	1110	1600	1600
	2"	870	750	440	350	210	60	370	290	640	540	960	840	1430	1263

100 kPa = 1 bar = 10 m_{H₂O}

* with MVH.A in emergency valve closed, with MVH.C in emergency valve open.

MAX REGULATION DIFFERENTIAL PRESSURE [kPa]

The max regulation differential pressure, it means the pressure which can be used during the stroke, is conditioned by wear between seat and plug and by the performance guaranteed by the actuator for the evaluated valve. So we recommend not to overcome the differential pressure whose value corresponds to the minimum between 200kPa (maximum admitted value not to cause wear) and the one shown in

ACCESSORIES

- AG52** Mounting kit for MVE actuator
- AG62** Mounting kit for MVH actuator
- AG63** Mounting kit for MVE..S actuator
- GVB3** Thermal insulation for DN20 valves (V.B3F)
- GVB4** Thermal insulation for DN25 valves (V.B4F)
- GVB5** Thermal insulation for DN32 valves (V.B5F)
- GVB6** Thermal insulation for DN40 valves (V.B6F)
- GVB8** Thermal insulation for DN50 valves (V.B8F)
- GVB8A** Thermal insulation for DN50 valves (V.B8AF)

the previous table (max close-off differential pressure).

Note: The max operating pressures at different temperatures for various PN classes must correspond to the following standards: UNI 1092-02 and UNI 12516-1.

DIMENSIONS [mm]

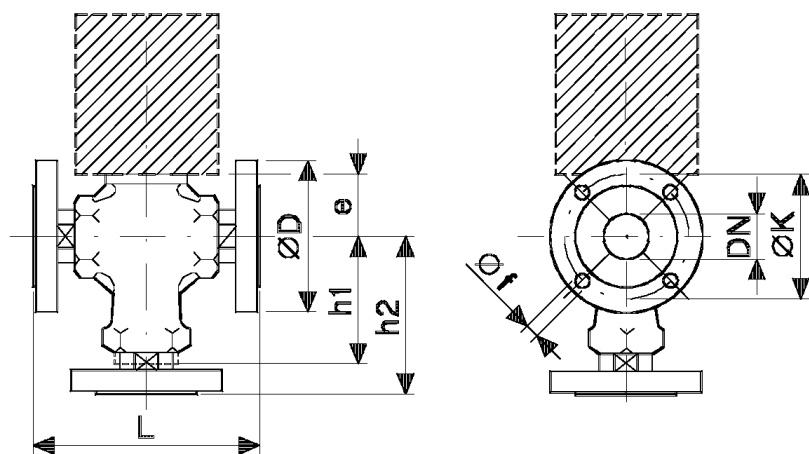

DN	$\varnothing D$	$\varnothing K$	$\varnothing f$	Holes	L	VSB.F	VMB.F	Weight [kg]	
						h1	h2	VSB.F	VMB.F
20	105	75	14	4	150	79	100	3,5	4,5
25	115	85	14	4	160	83	105	4,3	5,5
32	140	100	18	4	180	90	114,5	6,2	8
40	150	110	18	4	200	98	125,5	7,5	9,8
50 (V.B8AF)	165	125	18	4	254	111	127	11,5	14,2
50 (V.B8F)	165	125	18	4	230	111	141	11,5	14,2

The performances stated in this sheet can be modified without any prior notice