



**Technology  
that saves lives.**

**Fire damper actuators**

**BELIMO®**

# More performance, more value – more safety.

Fires represent the greatest potential threat to people and tangible assets in buildings. Efficient fire protection saves lives in case of emergency, helps minimise property damage and secures the continued operation of companies. The best protection against the spread of fire and smoke through the air ducts is provided by the motorised fire dampers to form fire compartments.

In case of fire, Belimo safety actuators for fire dampers automatically move into their safety positions and keep the dampers closed during the fire.



## Safety is top priority

- Responsible fire protection requires practical solutions with suitable products.
- As a rule, the owner and/or the operator are responsible for proper functioning of the fire protection systems during the entire building life cycle.
- Prescribed inspections must be carried out and logged periodically.

## Belimo offers more

As a reliable supplier of tested fire damper actuators, we provide you with safety through:

- long years of experience
- market-appropriate, proven solutions
- tested Swiss quality
- local, experienced contacts
- fire protection solutions which are oriented to the building life cycle
- a complete product range
- the maximum in delivery reliability.

## Motorised fire dampers

In case of fire, they are moved into the safety position (closed) by means of the spring energy of the fire damper actuator when:

- the operating temperature is exceeded in the duct or in the environment
- triggered by a smoke detector
- the supply voltage fails
- the air conditioning plant is shutdown
- the fire alarm system triggers.

In case of fire, the Safety Position Lock™ function keeps the motorised fire dampers in the safety position.

## Reliability and profitability

Customers benefit from the following advantages:

- Maximum safety through reliable closing and holding of the damper in the safety position
- The possibility of scenario control by means of intelligent controls and the integration of sensors
- The protection of the infrastructure in the event of a power failure through automatic closing of the fire damper by means of the spring energy of the actuator
- Central monitoring and automated function tests
- Reduced maintenance and operating costs

## Standards and state-of-the-art

- The "state-of-the-art technology"<sup>1)</sup> must be considered in addition to the technical regulations (e.g. standards).
- In Europe, fire dampers are manufactured according to the product standard EN 15650, checked with fire resistance testing pursuant to EN 1366-2 and classified according to EN 13501-3.



### 1) FURTHER LITERATURE ON THE SUBJECT:





- Expert opinion "Motorized fire dampers and the generally accepted (state-of-the-art) technical standards" from the attorneys-at-law Heiermann Franke Knipp, Essen, Germany, 2002
- Technical Paper "The role of motorised damper control in legislation" by Peter E. Jackman, International Fire Consultants Ltd., Great Britain, 2004

# Full product range, proven motorisation solutions.

Belimo supplies cost-effective and easy-to-integrate solutions for the motorisation of fire dampers.

## BFL





- Optimised actuator with slim design for small and medium fire dampers
- Simple and fast installation
- In case of fire, the patented Safety Position Lock™ solution reliably keeps the fire damper closed

<b>Torque</b>	 4 Nm  3 Nm
<b>Power consumption:</b> <b>AC/DC 24 V</b> <b>AC 230 V</b>	In operation 2.5W / at rest 0.8 W In operation 3.5W / at rest 1.1 W
<b>Angle of rotation</b>	95°
<b>Running time</b>	 <60 s  20s
<b>Spindle driver</b>	Form fit 12x12 mm
<b>Thermoelectric tripping device (T)</b>	



## BFN

- Powerful actuator for medium and large fire dampers in flat design
- Simple and fast installation
- In case of fire, the patented Safety Position Lock™ solution reliably keeps the fire damper closed

<b>Torque</b>	 9 Nm  7 Nm
<b>Power consumption:</b> <b>AC/DC 24 V</b> <b>AC 230 V</b>	In operation 4W / at rest 1.4 W In operation 5W / at rest 2.1 W
<b>Angle of rotation</b>	95°
<b>Running time</b>	 <60 s  20s
<b>Spindle driver</b>	Form fit 12x12 mm
<b>Thermoelectric tripping device (T)</b>	







**Note**

Fire damper actuators are only supplied to fire damper manufacturers.





**BF**

- Well established actuator for large fire dampers with high torque requirements

<b>Torque</b>	 	18 Nm 12 Nm
<b>Power consumption:</b> <b>AC/DC 24V</b> <b>AC 230V</b>		In operation 7W / at rest 2W In operation 8.5W / at rest 3W
<b>Angle of rotation</b>		95°
<b>Running time</b>	 	< 120 s 16 s
<b>Spindle driver</b>		Form fit 12x12 mm
<b>Thermoelectric tripping device (TN)</b>		

**BFG**

- Well established actuator for medium and large fire dampers with 180° (with linkage)

<b>Torque</b>	 	11 Nm 8.5 Nm
<b>Power consumption:</b> <b>AC/DC 24V</b> <b>AC 230V</b>		In operation 7.5W / at rest 2W In operation 9.5W / at rest 3.5W
<b>Angle of rotation</b>		180°
<b>Running time</b>	 	< 120 s 20 s
<b>Spindle driver</b>		Form fit 10x10 mm
<b>Thermoelectric tripping device (TN)</b>		



# Compact and powerful due to innovative technology.

## Noticeable position indication

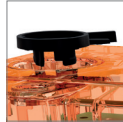

## Casing made from premium engineering polymer

- Fulfills the requirements of EN 15650
- Suitable for fire safety applications
  - Halogen-free flame retardant
  - High glow wire resistance

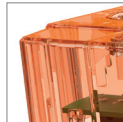

## Integrated auxiliary switches

- Potential-free
- Fixed switching points



## Form fit made of steel

- Safe connection to damper spindle

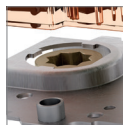

## Steel hollow pillars

- Simple and fast installation



## Safety Position Lock™

- Reliably holds the fire damper in the safety position in case of fire
- Patented technical solution
  - Integrated as standard
  - Not resettable

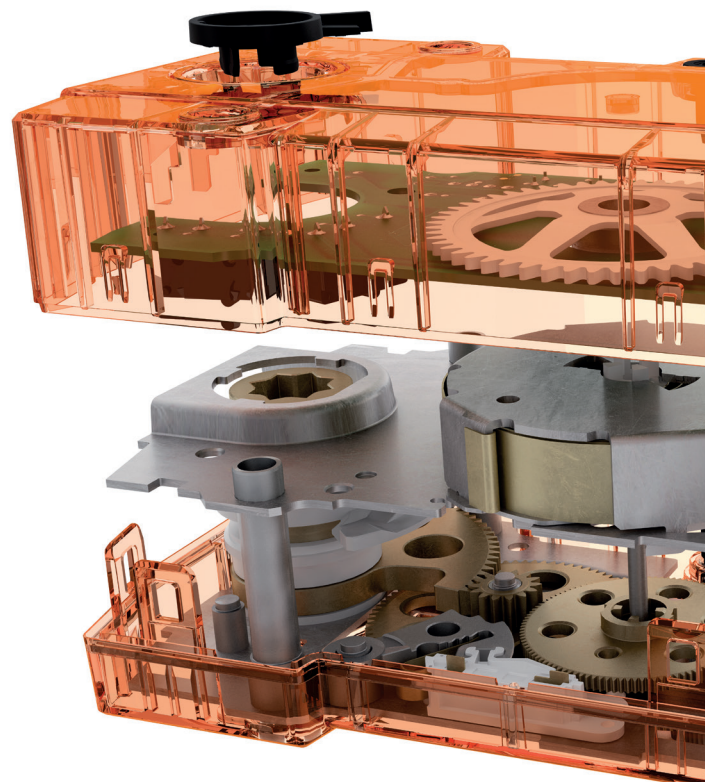

## Safety Position Lock™



Normal operation



Fire condition



Actuator: BFN

**Position lock**

- Position lock of manual override control
- Position lock releases when supply voltage is applied

**Connecting cable**

- Halogen-free
- Optional with plug
- With colour coding

**Thermoelectric tripping device**

- Protected function of supply line
- LED status indicator
- Checking the damper function on site using the test button
- Tested according to ISO 10294-4

**Manual override control**

- Integrated overload protection
- Freewheel function prevents blocking by hand crank

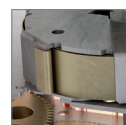
**Spring assembly made of steel**

- Secure closing in case of fire

**Steel gear-box**

- Robust
- Fire-resistant

## General Information

- 100 % testing of the functions of all actuators prior to delivery
- 60,000 safety positions guaranteed under nominal load
- Controlled closing of the fire damper reduces loading of the ventilation duct
- Reduction of power consumption in the rest position (open)
- Maintenance-free



# Conventional and digital control & monitoring.

## Conventional control with position feedback

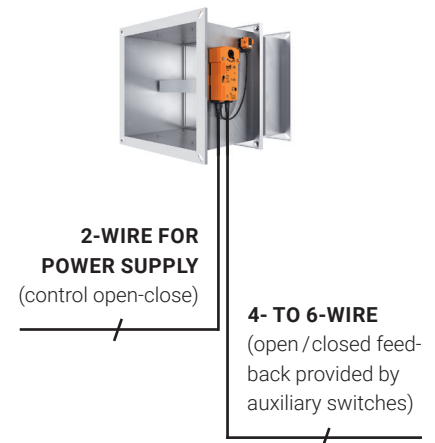
<b>Actuator types</b>	<ul style="list-style-type: none"> <li>– BFL/BFN/BF</li> <li>– BFG: 24/24-T(N)/230/230-T(N)</li> </ul> <p>T(N) = Thermoelectric tripping device</p>
<b>Connection to control cabinet</b>	<ul style="list-style-type: none"> <li>– Cables for motors and auxiliary switches wired directly to control cabinet</li> <li>– Feedback of damper position by means of auxiliary switches</li> </ul>
<b>Note</b>	For 24V actuators, the voltage drop over long lines should be noted. The voltage at the actuator must be within the tolerance stated in the data sheet.



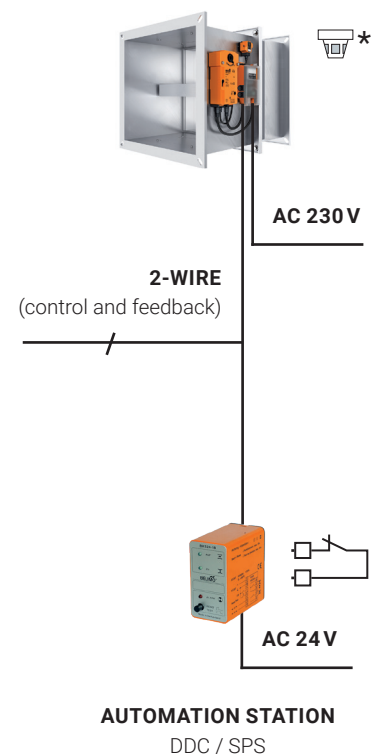

## Control and monitoring via SBS-Control

<b>Actuator types</b>	<ul style="list-style-type: none"> <li>– BFL/BFN/BF</li> <li>– BFG: 24-T(N)-ST/24-ST</li> </ul> <p>T(N) = Thermoelectric tripping device ST = With plug</p>
<b>Connection to automation station</b>	<p><b>Communication and power supply unit BKN230-24</b></p> <ul style="list-style-type: none"> <li>– Decentralised power supply unit for 24V fire damper actuators</li> <li>– Local power supply AC 230V</li> <li>– Integrated LED status indicator</li> <li>– Connection for a smoke detector contact and/or a thermoelectric tripping device</li> </ul>  <hr/> <p><b>Communication and control unit BKS24-1B and plug socket ZSO-11</b></p> <ul style="list-style-type: none"> <li>– For controlling and monitoring of a fire damper</li> <li>– 3 LEDs for indicating operating statuses and faults</li> <li>– Function test of fire damper actuator</li> <li>– Potential-free auxiliary contacts for integration into system</li> </ul> 





## Control and monitoring via SBS-Control

<b>Actuator types</b>	<ul style="list-style-type: none"> <li>- BFL/BFN/BF</li> <li>- BFG: 24-T(N)-ST/24-ST</li> </ul> <p style="margin-left: 20px;">T(N) = Thermoelectric tripping device ST = With plug</p>
<b>Connection to automation station</b>	<p><b>Communication and power supply unit BKN230-24</b></p> <ul style="list-style-type: none"> <li>- Decentralised power supply unit for 24V fire damper actuators</li> <li>- Local power supply AC 230V</li> <li>- Integrated LED status indicator</li> <li>- Connection for a smoke detector contact and/or a thermoelectric tripping device</li> </ul>  <hr/> <p><b>Communication and control unit BKS24-9A</b></p> <ul style="list-style-type: none"> <li>- Controls and monitors for up to 9 fire dampers</li> <li>- LED status display indicating operating statuses and fault messages</li> <li>- Function test of fire damper actuators</li> <li>- Potential-free auxiliary contacts for integration into system</li> <li>- Zone control and summarised alarms</li> </ul> 

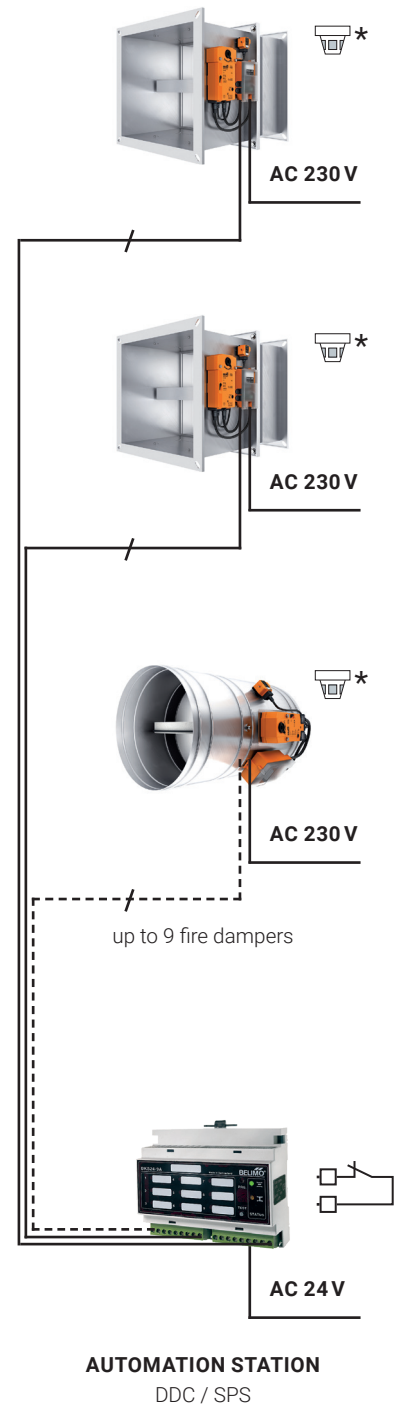

\*Optional: smoke detector with potential-free contact

# Communicative bus solutions.

## Modbus RTU and BACnet MS/TP via Belimo field unit BKN230-24-MOD

<b>Actuator types</b>	<ul style="list-style-type: none"> <li>- BFL/BFN/BF</li> <li>- BFG: 24-T(N)-ST/24-ST</li> </ul> <p>T(N) = Thermoelectric tripping device ST = With plug</p>
<b>Connection modules</b>	<ul style="list-style-type: none"> <li>- Interface to Modbus RTU</li> <li>- Interface to BACnet MS/TP</li> <li>- Baud rate up to 76'800 Bd</li> <li>- Termination can be switched</li> <li>- Parameterisation adjustable via DIL switch</li> <li>- Changing from Modbus to BACnet via DIL switch</li> </ul> 

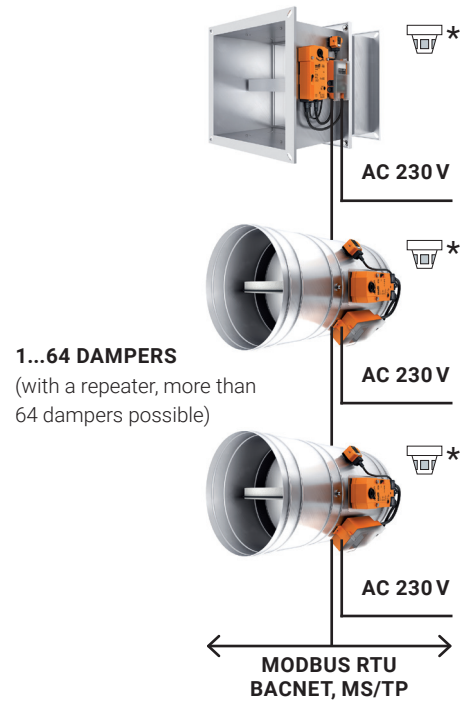

## Connection to various protocols via MP-Bus® and DDC-Controller

<b>Actuator types</b>	<ul style="list-style-type: none"> <li>- BFL/BFN/BF</li> <li>- BFG: 24-T(N)-ST/24-ST</li> </ul> <p>T(N) = Thermoelectric tripping device ST = With plug</p>
<b>Connection modules</b>	<p><b>Communication and power supply unit BKN230-24-C-MP</b></p> <ul style="list-style-type: none"> <li>- Interface to MP-Bus</li> <li>- Decentralised power supply unit for 24V fire damper actuators</li> <li>- Local power supply AC 230 V</li> <li>- Integrated LED status indicator</li> <li>- Connection for a smoke detector contact and/or a thermoelectric tripping device</li> </ul> 
<b>Gateways</b>	<p><b>DDC controller with MP interface</b></p> <p>Belimo provides the MP specifications to all manufacturers of DDC controllers. They can use these specifications to implement own hardware /software design into their devices.</p>

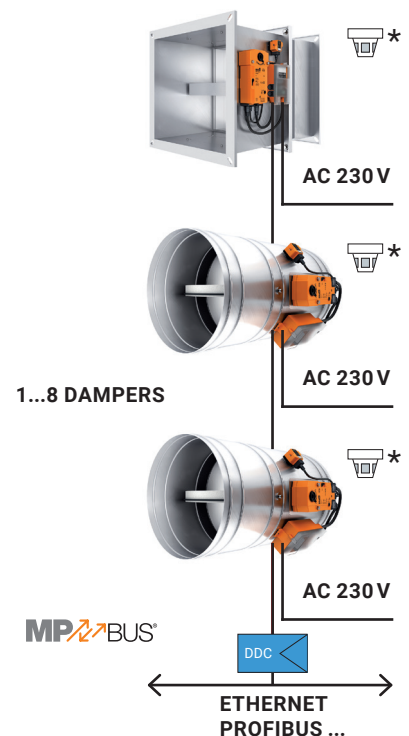

## Efficient planning with BIM

Building Information Modeling (BIM) is the modern method of planning, constructing and managing buildings. With its world-leading actuator, valve and sensor solutions, Belimo is helping to make BIM even more efficient for every field of application. You and your customers benefit from these advantages:

- Belimo plug-in for the selection of 3D data models with technical information from Autodesk Revit
- Only one database for all actuators, valves and sensors from Belimo
- Planning, deadline and cost security
- Transparency in all Belimo product data
- Up-to-date, improved quality information for all project participants is available immediately

Planning with digital building models from BIM guarantees a significant increase in productivity and, at the same time, a reduction in planning errors. Use BIM with Belimo as a reliable partner.



Find out more at  
[www.belimo.eu/BIM](http://www.belimo.eu/BIM)

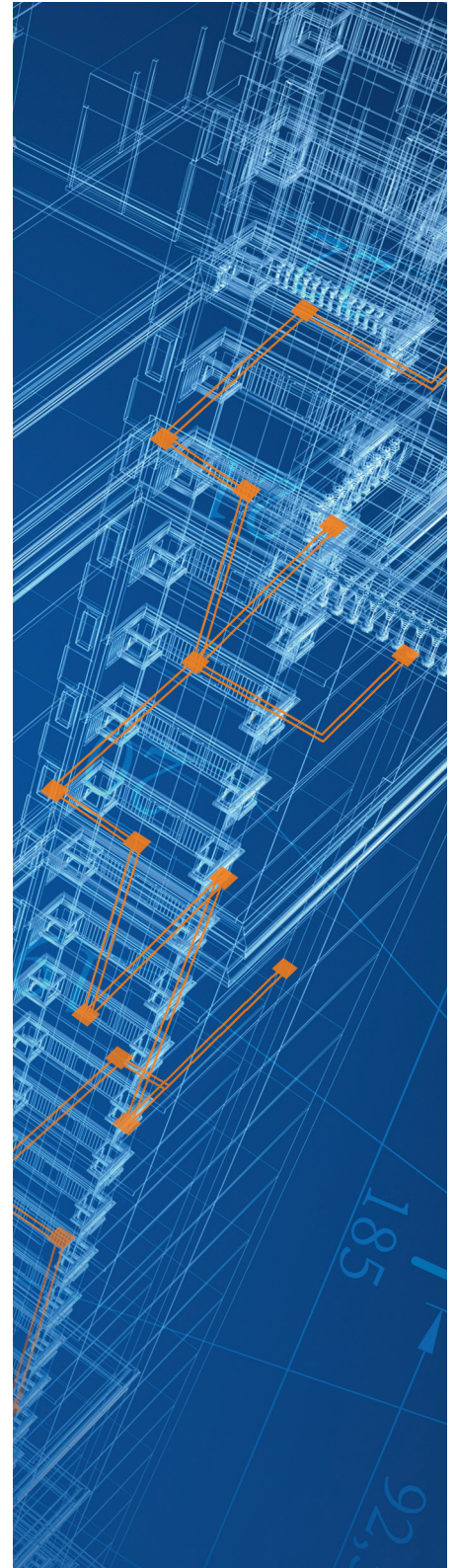

# All inclusive.

Belimo as a global market leader develops innovative solutions for the controlling of heating, ventilation and air-conditioning systems. Actuators, valves and sensors represent our core business.

Always focusing on customer added value, we deliver more than only products. We offer you the complete product range for the regulation and control of HVAC systems from a single source. At the same time, we rely on tested Swiss quality with a five-year warranty. Our worldwide representatives in over 80 countries guarantee short delivery times and comprehensive support through the entire product life. Belimo does indeed include everything.

The "small" Belimo devices have a big impact on comfort, energy efficiency, safety, installation and maintenance. In short: Small devices, big impact.



5-year warranty



On site around the globe



Complete product range



Tested quality



Short delivery times



Comprehensive support



**BELIMO Automation AG**

Brunnenbachstrasse 1, 8340 Hinwil, Switzerland

Fon + 41 43 843 61 11, [info@belimo.ch](mailto:info@belimo.ch), [www.belimo.com](http://www.belimo.com)

**BELIMO**<sup>®</sup>